

Serie 04V

VALVOLE A PANNELLO, PULSANTI E SELETTORI

PANEL VALVE, PUSH BUTTONS AND SELECTORS

MIKROVENTILE FÜR SCHALTAFELEINBAU, DRUCKTASTER UND SCHALTER

DISTRIBUTEURS POUR COMMANDES EN PANNEAU ET BOUTONS

VÁLVULAS DE PANEL, PULSADORES Y SELECTORES

VÁLVULA PARA PAINEL, BOTÕES E SELETOR



MICROVALVOLE

MICROVALVE
MIKRO VENTILE
MICRODISTRIBUTEURS
MICROVÁLVULAS
MICRO-VÁLVULA

3/2 Vie - Ways - Wege - Voies - Vías - Vias

MICROVALVOLE A PUNTALE

TAPPET MICROVALVE

STÖBEL - MIKROVENTIL

MICRODISTRIBUTEUR À POUSSOIR

MICROVÁLVULA DE PUNTAL

MICRO-VÁLVULA DE ACIONAMENTO DIRETO NO PINO

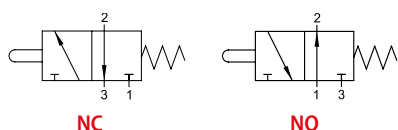

NC

NO

Codice Code Nummer Code Código Código	Vie Ways Wege Voies Vias Vias	Funzione Function Funktion Fonction Función Funções	Misura Size Größe Dimension Medida Tamanho	Pack.
02V G0 3 NC B5	3/2	NC	M5	1
02V G0 3 NO B5	3/2	NO	M5	1

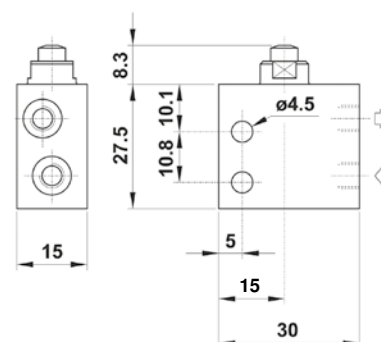

3/2 Vie - Ways - Wege - Voies - Vías - Vias

MICROVALVOLE PER ATTUATORE DA PANNELLO

MICROVALVE FOR PANEL MOUNTING ACTUATOR

STÖBEL - MIKROVENTIL, SCHALTAFELEINBAU

MICRODISTRIBUTEUR À POUSSOIR, MONTAGE EN PANNEAU

MICROVÁLVULA PARA ACTUADORES DE PANEL

MICRO-VÁLVULA PARA ATUADOR DE PAINEL

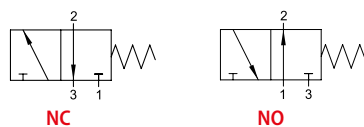

NC

NO

Codice Code Nummer Code Código Código	Vie Ways Wege Voies Vias Vias	Funzione Function Funktion Fonction Función Funções	Misura Size Größe Dimension Medida Tamanho	Pack.
02V D0 3 NC B5	3/2	NC	M5	1
02V D0 3 NO B5	3/2	NO	M5	1

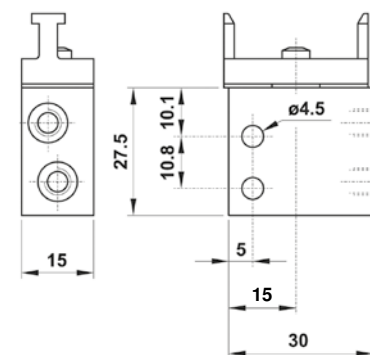

INTERFACCIA PER ATTACCO PULSANTE

INTERFACE FOR CONNECTION BUTTON

ADAPTER ZUM ANSCHLUSS VON TASTEN

ADAPTATEURS POUR BOUTONS DE COMMANDE

INTERFACE PARA CONEXIÓN PULSADOR

INTERFACE PARA MONTAGEM DE BOTÃO

Codice Code Nummer Code Código Código		Pack.
04V 06 0 00 01	SINGOLA - SINGLE - EINZELN - UNIQUE - INDIVIDUAL - SIMPLES	1
04V 06 0 00 02	DOPPIA - DOUBLE - DOPPELT - DOUBLE - DOBLE - DUPLA	1



04V 06 0 00 02

04V 06 0 00 01



PULSANTI E SELETTORI

PUSH BUTTON AND SELECTOR
 DRUCKTASTER UND SCHALTER
 BOUTONS POUSSOIRS OU TOURNANTS
 PULSADORES Y SELETORES
 BOTÕES PULSANTES E SELETORES

PULSANTE PROTETTO

PROTECTED PUSH BUTTON
 DRUCKTASTER, VERSENKT
 BOUTON POUSSOIR, AFFLEURANT
 PULSADOR CON PROTECCIÓN
 BOTÃO PULSANTE PROTEGIDO

Codice Code Nummer Code Código Código	Colore Standard Standard Color Standard Farbe Couleur Standard Cores Standard Cores Padrão	Pack.
04V 01 0 00 01		1

Codice Code Nummer Code Código Código	Colore Color Farbe Couleur Cores Cores	Pack.
04V 01 P 00 VE		1
04V 01 P 00 GI		1
04V 01 P 00 AZ		1



I seguenti colori sono disponibili ordinandoli in aggiunta al kit standard.

The following colors can be ordered separately.

Folgende Farben können separat bestellt werden.



Les couleurs ci-dessus peuvent être commandées séparément.

Los siguientes colores están disponibles añadiéndolos al kit standard.

As seguintes cores estão disponíveis quando compradas em conjunto com o kit standard.

FUNGO MONOSTABILE ASSIALE

AXIAL MONO-STABLE MUSHROOM
 PILZDRUCKTASTER, MONOSTABIL
 BOUTON COUP DE POING, MONOSTABLE
 SETA MONOESTABLE AXIAL
 COGUMELO MONOESTÁVEL AXIAL

Codice Code Nummer Code Código Código	Colore Color Farbe Couleur Cores Cores	Pack.
04V 02 0 0N 01		1
04V 02 0 0R 01		1



FUNGO SBLOCCO A ROTAZIONE

TURN TO UNLOCK MUSHROOM
 PILZDRUCKTASTER, DRUCK-DREH-TASTE
 BOUTON COUP DE POING, POUSSER-TOURNER
 SETA SEGURIDAD DESBLOCAJE A ROTACIÓN
 COGUMELO COM TRAVA POR ROTAÇÃO

Codice Code Nummer Code Código Código	Colore Color Farbe Couleur Cores Cores	Pack.
04V 02 0 0R 02		1

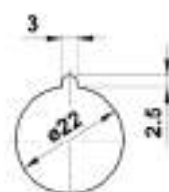

Foro per montaggio a pannello con asola antirotazione.

Panel mounting hole with antirotation feature.

Einbauausschnitt mit Verdrehsicherungs-Bohrung.

Implantation avec trou anti-rotation.

Taladro para montaje a panel con dispositivo antirotación.

Furo para montagem em painel com encaixe anti- rotação.

SELETTORE A CHIAVE

KEY SELECTOR
SCHLÜSSELSCHALTER
BOUTON TOURNANT, À CLÉ
SELECTOR DE LLAVE
SELETOR COM CHAVE

Codice Code Nummer Code Código Código	Colore Color Farbe Couleur Colores Cores	Funzione Function Funktion Fonction Función Funções	Posizione estrazione chiave Position to pull the key out Schlüsselabnahme Retrait de clé Posición extracción llave Posição de retirada da chave	Pack
04V 03 0 00 01	■	0 - 1	Solo centrale Only in central position Nur in zentraler Position Que dans la position centrale Sólo central Central	1
04V 03 0 00 02	■	0 - 1	Ambedue Both position Beide Les deux Ambas posiciones Ambas as posições	1
04V 03 0 00 03	■	2 - 0 - 1	Solo centrale Only in central position Nur in zentraler Position Que dans la position centrale Sólo central Central	1

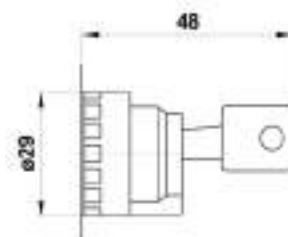

SELETTORE A LEVA CORTA

SHORT LEVER SELECTOR
DREHSCHALTER
BOUTON TOURNANT
SELECTOR DE LEVA CORTA
SELETOR DE ALAVANCA CURTA

Codice Code Nummer Code Código Código	Colore Color Farbe Couleur Colores Cores	Funzione Function Funktion Fonction Función Funções	Pack.
04V 04 0 0N 01	■	0 1	1
04V 04 0 0N 02	■	0 ← 1	1
04V 04 0 0N 03	■	2 0 1	1
04V 04 0 0N 04	■	2 → 0 ← 1	1

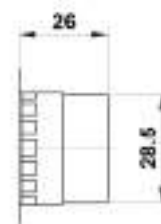

SELETTORE A LEVA LUNGA

LONG LEVER SELECTOR
DREHHEBEL
BOUTON TOURNANT À LEVIER
SELECTOR DE LEVA LARGA
SELETOR DE ALAVANCA LONGA

Codice Code Nummer Code Código Código	Colore Color Farbe Couleur Colores Cores	Funzione Function Funktion Fonction Función Funções	Pack.
04V 05 0 0N 01	■	0 1	1
04V 05 0 0N 02	■	0 ← 1	1
04V 05 0 0N 03	■	2 0 1	1
04V 05 0 0N 04	■	2 → 0 ← 1	1

