



## 12.2 ANGULAR CONTACT BALL BEARINGS

Angular contact ball bearings have raceways of bearing rings designed so that the joins of their contact points and balls contain sharp angle, the so-called contact angle, with the vertical line towards the axis. The bearings are non separable. Separable are some special bearings, or bearings with multipoint contact of QJ type. These bearings are suitable for transfer of combined loads, the so-called simultaneously acting radial and axial loads. With increasing contact angle the axial load bearing capacity grows whilst the radial load bearing capacity slowly reduced.

Dunlop BTL manufacture angular contact ball bearings in many versions and dimensions for use in general engineering. The chart section of the catalogue states the standard assortment of Dunlop BTL bearings with main dimensions and parameters divided as follows:

- Single row angular contact ball bearings
- Single row angular contact ball bearings for high revolution frequency
- Double row angular contact ball bearings
- Four Point Contact Ball Bearings

### Single row angular contact ball bearings

Single row angular contact ball bearings are capable of transferring axial force only in one direction, and are not separable. B and BE design bearings have contact angle  $40^\circ$ . This design allows the bearing to capture radial load acting simultaneously with relatively big axial load in one direction. In order capture axial load in both direction bearings are mounted in pairs opposite each other. BE version bearings have modified inner design in order to transfer bigger load.

The production program includes bearings with contact angle  $25^\circ$  which have additional designation A, alternatively with  $26^\circ$  identified AA. These bearings are made in P5 and P4 accuracy levels, and are designed for location of machine tool and similar machine spindles with relatively higher axial load.

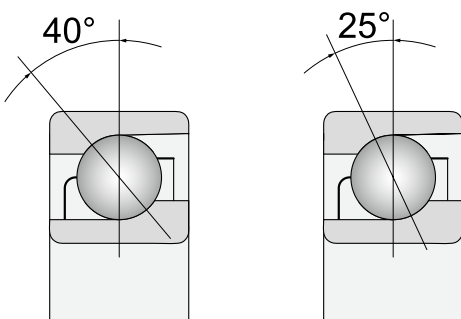

Fig. 12.2.1





## SINGLE ROW ANGULAR CONTACT BALL BEARINGS FOR HIGH REVOLUTION FREQUENCY

Single row angular contact ball bearings of A70 and A72 type with symmetrical outer ring, or B70 and B72 with symmetrical inner ring are designed for high revolution frequencies. They differ from common bearings of this design group not only in the inner design of bearing raceways but also in the size of the contact angle, design of cage and high accuracy level.

C design bearings have contact angle  $15^\circ$  and are made in the P5, P5A and P4, P4A accuracy classes. They are used mostly for location of spindles of machine tools and similar equipment. CA design bearings have contact angle  $12^\circ$ . CB version bearings have contact angle  $10^\circ$ . They are usually made in the P4 and P4A accuracy level and are designed for very accurate locations with high revolution frequency, e.g. for electric grinding spindles and instruments.

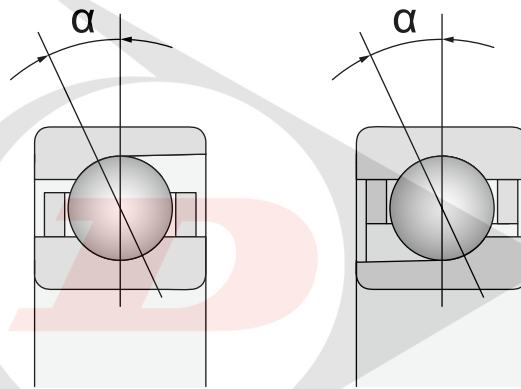

Fig. 12.2.2

### Main dimensions

Main dimensions comply with the international standard ISO 15 and are stated in the table section.

### Designation

The system of designating the bearings in basic version forms a part of the data stated in the table section. Difference from the basic design is identified with additional characters as advised in chapter 7.6. The characteristics of individual design variants are described below.

### Cages

The 72 and 73 type bearings in B, BE and A versions are supplied with massive brass cage guided on rolling elements (M). Bearings can be also supplied with a sheet-metal cage that is not identified, or with a massive polyamide cage reinforced by glass fibres (TNG).



Bearings intended for high revolution frequencies are supplied with a massive cage of reinforced fabric – textit – guided on the outer ring (TA), or guided on the inner ring (TB). These bearings can be supplied even with a massive brass cage (M).

## Accuracy

Single row 72 and 73 type angular contact ball bearings are usually made in normal accuracy level P0 whilst this symbol is not presented. For more exacting locations bearings are supplied in higher accuracy level P6 or P5.

Bearings intended for high revolutions are supplied in higher accuracy levels P5 and P4, alternatively P4A

The limit values of bearing dimension and run accuracy deviations comply with the standard ISO 492, and are stated in charts 7.2 and 7.3. Limit tolerance values for bearings of higher accuracies are stated in charts 7.4 to 7.8. Limit tolerance values of installation fillet are stated in chart 7.1. These values comply with the standard IS 82.

## Misalignment

Single row angular contact ball bearings can only balance misalignment to certain limited extent. The allowed misalignment of shaft against the element which does not cause inadmissibly high additional load depends on the service clearance in the bearing, size of bearings, inner design and forces and torques acting on the bearing. Considering unusually complex relations between individual factors, no generally applicable values can be stated. If bearings are mounted in pairs, especially in the arrangement with backs opposite one another (in the "O" layout) with small axial inner clearance, the misalignment can only be compensated by increased load of the balls that will cause higher stress of the cage and reduce the service durability of the bearings. More suitable for locations with small misalignment is the layout of bearings with fronts to each other (in the „X" layout) which has smaller rigidity in tilting. Any misalignment also causes increased noise level during the bearing run.

## Association of bearings

The A70, A72, B70 and B72 version bearings designed for high revolution frequencies are supplied by the manufacturer associated in pairs, triplets or quaternions. Bearing can also be supplied as universally coupled.

Various arrangements of bearings are shown in the figure 12.2.3.

## Associated pair "O"

Pair features high rigidity against misalignment and transfers axial forces in both directions through one bearing only. It is used to capture overturning torque.

## Associated pair "X"

Pair has the same abilities in terms of transfer of axial forces as the "O" arrangement, but lower rigidity in capturing overturning torque.

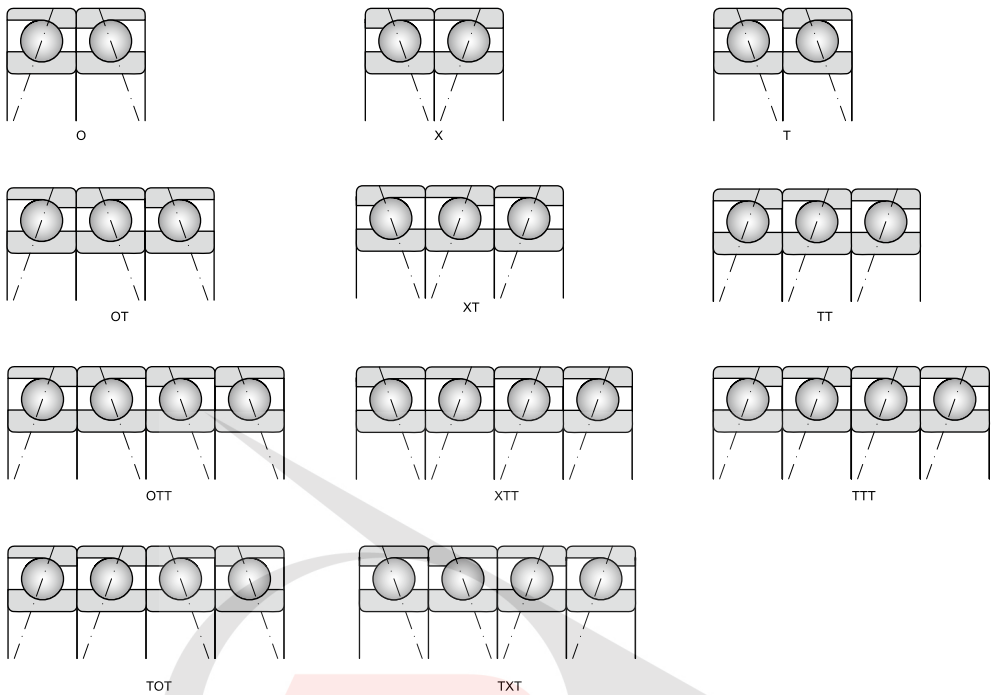

Fig. 12.2.3

### Associated pair "T"

Pair features high rigidity in capturing overturning torque but is able to transfer axial load in one direction only.

### Association of bearings in triplets and quaternions

For special locations that require high accuracy, rigidity, load bearing capacity and high revolution frequency, bearings of A70, A72, B70 and B72 type are supplied, combined in triplets and quaternions. The scheme of such arrangement is indicated in par. 2.2.

Considering the specifics of such cases, any use of the arrangement in triplets and quaternions should be discussed with the supplier.

Associated pair is supplied in a joint packaging in order to prevent confusion and the place of the biggest radial runout is for the assembly purposes marked with a punch mark on the face of rings. Mutual position of rings opposite each other is marked with concurring lines in "V" shape on the outer cylindrical surface of the associated pair. Bearings are mounted in location so that the punch marks identifying the place of the biggest radial runout are situated on the line that runs in parallel to the shaft axis.



## Universal association of bearings

Bearings for universal pairing are produced in such tolerances that allow in any arrangement achieving of required prestress or tolerance without additional re-grinding of rings, or use of spacing washers. Additional identification of universal bearings contain the U symbol in combination with character that defines the final clearance or prestress range (UA2, UA, UA3, UO, UL, UM, US). Bearings can be arranged in location only in pairs of the same version. Thus, bearings can be mounted in tandems to capture bigger forces where one bearing is not enough; with the fronts or backs opposite each other.

## Internal clearance and prestress

Usual method of use of single row angular contact ball bearings is in a pair where suitable service clearance or prestress are set during the assembly and depends on the construction of location and service conditions.

Dunlop BTL bearings intended for pairing are made for association with three clearance values, without clearance and three prestress values.

- A . . . . . association of bearings with normal clearance
- A2 . . . . . association of bearings with clearance smaller than normal
- A3 . . . . . association of bearings with clearance bigger than normal
- O . . . . . association of bearings without clearance
- L . . . . . association of bearings with small prestress
- M . . . . . association of bearings with medium prestress
- S . . . . . association of bearings with big prestress

## Size of internal clearance and prestress

Indicative values of axial prestress can be determined upon the below relation:

$$F_p = k C_r 10^{-2}$$

where:

$F_p$  . . . . . axial prestress

$k$  . . . . . coefficient of axial prestress according to table 12.2.1

$C_r$  . . . . . radial dynamic load rating

Values of axial clearance of universally pairable bearings in pair with backs or front opposite each other are available in table 12.2.2



Table 12.2.1

Axial prestress		Coefficient K			
Size	Designation	Contact angle $\alpha$			
		10°	12°	15°	26°
		Bearing design			
		CB	CA	C	AA
Small	L	0,4	0,5	0,7	1,2
Big	M	1,4	1,6	2	3,5
Big	S	2,8	3,2	4	7

Table 12.2.2

Bore diameter		Axial Internal clearance, Class					
over	including	A2		A		A3	
		min	max	min	max	min	max
mm		$\mu\text{m}$					
10	18	5	13	15	23	24	32
18	30	7	15	18	26	32	40
30	50	9	17	22	30	40	48
50	80	11	23	26	38	48	60
80	120	14	26	32	44	55	67
120	180	17	29	35	47	62	74
180	250	21	37	45	61	74	90

### Load rating of bearings mounted in pairs

The load bearing capacity values stated in tables apply to individual bearings. The following values apply to the use in pairs:

Dynamic load rating of pair in O or X arrangement:  $C_{r2} = 1.62 C_{r1}$  (of individual bearing)

Dynamic load rating of pair in T arrangement:  $C_{r2} = 2 C_{r1}$  (of individual bearing)

Static load capacity of pair  $C_{or2} = 2 C_{or1}$  (of individual bearing)



### Equivalent radial dynamic load

Bearings with contact angle of 40°

Individual bearings:

$$P_r = F_r \quad \text{for } F_a/F_r \leq 1.14$$

$$P_r = 0.35 F_r + 0.57 F_a \quad \text{for } F_a/F_r > 1.14$$

Bearings with contact angle of 25°

Individual bearings and associated bearings in T arrangement:

$$P_r = F_r \quad \text{for } F_a/F_r \leq 0.68$$

$$P_r = 0.41 F_r + 0.87 F_a \quad \text{for } F_a/F_r > 0.68$$

Associated pairs in O or X arrangement:

$$P_r = F_r + 0.92 F_a \quad \text{for } F_a/F_r \leq 0.68$$

$$P_r = 0.67 F_r + 1.14 F_a \quad \text{for } F_a/F_r > 0.68$$

Bearings with contact angle of 15°

Individual bearings and associated bearings in T arrangement:

$$P_r = F_r \quad \text{for } F_a/F_r \leq e$$

$$P_r = 0.44 F_r + Y F_a \quad \text{for } F_a/F_r > e$$

Associated pairs in O or X arrangement:

$$P_r = F_r + Y_1 F_a \quad \text{for } F_a/F_r \leq e$$

$$P_r = 0.72 F_r + Y_2 F_a \quad \text{for } F_a/F > e$$

$F_r$  and  $F_a$  are forces acting on a pair of bearings. If the shaft is located in two single row angular contact ball bearings, the acting radial clearance will distribute to radial and axial component. Axial load of one bearing depends on the load and size of the contact angle of the second bearing. These additional inner forces must be considered in calculation of bearing.



Table 12.2.3

$F_a/iC_{or}$	e	Y
0,015	0,38	1,47
0,029	0,40	1,40
0,058	0,43	1,30
0,087	0,46	1,23
0,12	0,47	1,19
0,17	0,50	1,12
0,29	0,55	1,02
0,44	0,56	1,00
0,58	0,56	1,00

Table 12.2.4

$F_a/iC_{or}$	e	Y <sub>1</sub>	Y <sub>2</sub>
0,015	0,38	1,65	2,39
0,029	0,40	1,57	2,28
0,058	0,43	1,46	2,11
0,087	0,46	1,38	2,00
0,12	0,47	1,34	1,93
0,17	0,50	1,26	1,82
0,29	0,55	1,14	1,66
0,44	0,56	1,12	1,63
0,58	0,56	1,12	1,63

The below table states relations for different arrangements of bearings during acting of external axial force  $K_a$ , radial force  $F_{ra}$  or - more precisely -  $F_{rb}$ . Radial forces act in the point of intersection of joint line with the shaft axis. [Dimension "a" is in the table section.] The calculation considers the force intensity in absolute values only. The calculated force  $F_a$  is instituted in the calculation of equivalent radial dynamic load  $P_r$ .

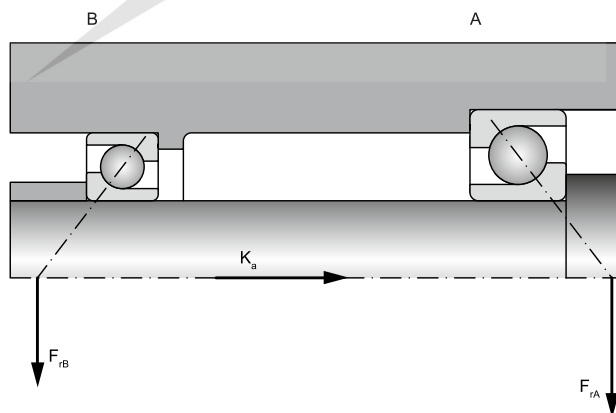

Fig. 12.2.7





Table 12.2.5

Arrangement of bearings	Force ratios	Axial load of bearings	
		Bearing A	Bearing B
See fig. 12.2.7 and 12.2.8	$F_{rA}/Y_A \leq F_{rB}/Y_B$ $K_a \geq 0$	$F_{aA} = F_{aB} + K_a$	$F_{aB} = e F_{rB}$
	$F_{rA}/Y_A > F_{rB}/Y_B$ $K_a \geq e (F_{rA} - F_{rB})$	$F_{aA} = F_{aB} + K_a$	$F_{aB} = e F_{rB}$
	$F_{rA}/Y_A > F_{rB}/Y_B$ $K_a < e (F_{rA} - F_{rB})^{1)}$	$F_{aA} = e F_{rA}$	$F_{aB} = F_{aA} - K_a$
See fig. 12.2.9 and 12.2.10	$F_{rA}/Y_A \geq F_{rB}/Y_B$ $K_a \geq 0$	$F_{aA} = e F_{rA}$	$F_{aB} = F_{aA} + K_a$
	$F_{rA}/Y_A < F_{rB}/Y_B$ $K_a < e (F_{rB} - F_{rA})$	$F_{aA} = e F_{rA}$	$F_{aB} = F_{aA} + K_a$
	$F_{rA}/Y_A < F_{rB}/Y_B$ $K_a < e (F_{rB} - F_{rA})^{1)}$	$F_{aA} = F_{aB} - K_a$	$F_{aB} = e F_{rB}$

<sup>1)</sup> Applies to  $K_a = 0$   
 For bearings with contact angle  $\alpha = 40^\circ$  (BE a B)  $e = 1,14$ ;  $Y = 0,57$   
 For bearings with contact angle  $\alpha = 25^\circ$  (A)  $e = 0,68$ ;  $Y = 0,87$   
 For other bearings e and Y accord. to tables 12.2.3 and 12.2.4

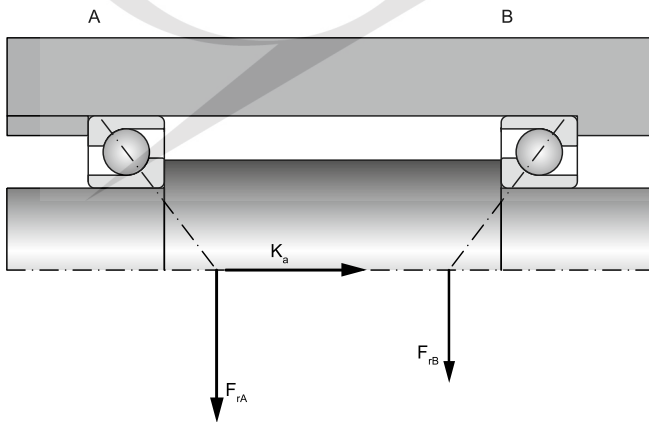

Fig. 12.2.8

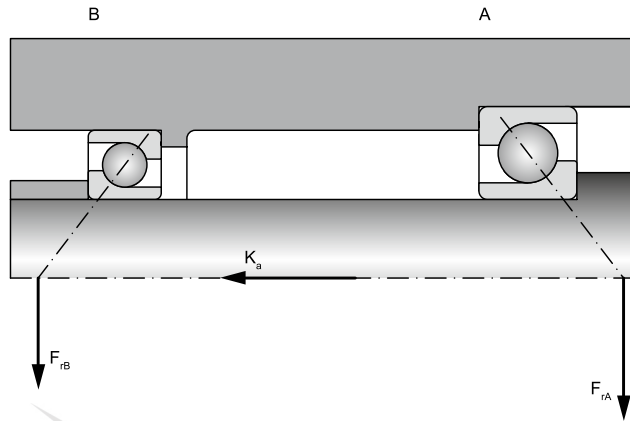

Fig. 12.2.9

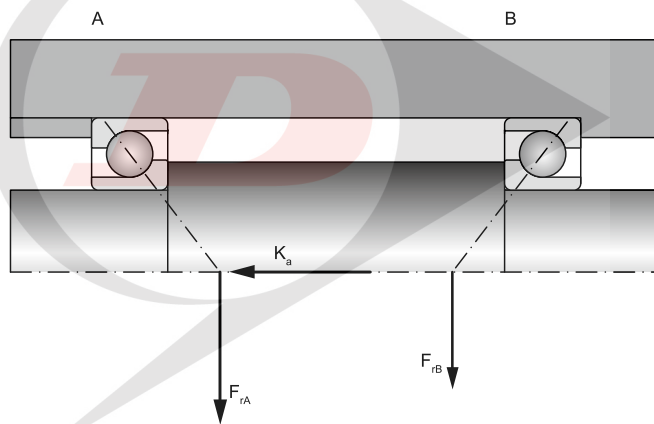

Fig. 12.2.10



### Equivalent radial static load

The following applies to individual bearings and bearings mounted in tandem:

$$P_{0r} = 0.5 F_r + 0.26 F_a \quad \text{for } P_{0r} \geq F_r$$

$$P_{0r} = F_r \quad \text{for } P_{0r} < F_r$$

The following applies to bearings mounted in O or X arrangement:

$$P_{0r} = F_r + 0.52 F_a \quad \text{for } P_{0r} \geq F_r$$

$$P_{0r} = F_r \quad \text{for } P_{0r} < F_r$$

### Location structure

Designing locations with single row angular contact ball bearings has to consider that these bearings must be used either with another bearing, or in pair. If single row angular contact ball bearings are used, they have to be arranged against each other to achieve the required pre-stress or clearance. If locations use bearings with universal pairing in contact next to each other, they need not be adjusted. Required prestress or clearance will be achieved by selecting a bearing of corresponding pre-stress or clearance class and proper location on the shaft and in the body.

Proper adjustment and selection of pre-stress or clearance are essential for correct function of the bearing and reliability of location. If the service clearance is e.g. too big, then the bearing's load bearing capacity will not be fully utilised, whilst excessive pre-stress will cause high friction and higher service temperature which will lead to shorter service durability of the bearing. It however has to be emphasized that proper rolling of single row ball bearings of 72B and 73B series (with contact angle 40°) is only ensured in case that  $F_a/F_r \geq 1$ .

Special attention has to be paid to a pair of bearings mounted with their backs opposite each other (in the "O" arrangement), or with their fronts opposite each other (in the "X" arrangement), when axial load prevails in one direction. Incorrect rolling of unloaded bearing balls in these conditions might cause noise, interruption of grease film and increased stress of the cage. Under such conditions it is advisable to have zero service clearance which can be achieved e.g. by the use of thrust springs, or by pairing of bearings with adequate pre-stress sizes.



Single row angular contact ball bearings d = 10 to 240 mm

d = 10 to 45 mm

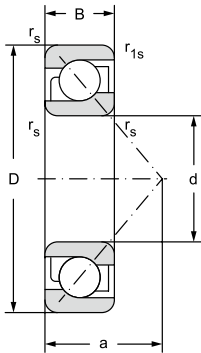

12.2.1

Main dimensions						Basic load rating		Fatigue load limit
d	D	B	r <sub>s</sub>	r <sub>1s</sub>	a	dynamic C <sub>r</sub>	static C <sub>0r</sub>	P <sub>H</sub>
mm						kN		kN
10	30	9	0,6	0,3	13,0	7,420	3,290	0,150
	30	9	0,6	0,3	13,0	7,020	3,350	0,140
12	32	10	0,6	0,3	14,0	8,030	3,780	0,172
	32	10	0,6	0,3	14,4	7,610	3,800	0,160
	37	12	1,0	0,6	16,3	10,600	5,000	0,208
15	35	11	0,6	0,3	12,0	9,580	4,880	0,222
	35	11	0,6	0,3	16,0	8,590	4,370	0,199
	42	13	1,0	0,6	18,0	13,900	6,580	0,299
	35	11	0,6	0,3	16,0	8,840	4,800	0,204
17	42	13	1,0	0,6	18,6	13,000	6,700	0,280
	47	14	1,0	0,6	15,0	16,600	7,890	0,359
	47	14	1,0	0,6	20,0	15,200	7,200	0,327
	47	14	1,0	0,6	20,0	16,300	8,000	0,364
20	47	14	1,0	0,6	15,0	16,400	8,540	0,388
	47	14	1,0	0,6	21,0	14,700	7,650	0,348
	47	14	1,0	0,6	21,0	16,700	8,650	0,393
	52	15	1,1	0,6	22,8	19,000	10,000	0,425
25	52	15	1,0	0,6	23,7	15,600	10,000	0,430
	62	17	1,1	0,6	27,0	26,800	14,600	0,664
	62	17	1,1	0,6	27,0	26,800	14,600	0,664
30	62	16	1,0	0,6	27,3	24,000	15,600	0,655
	72	19	1,1	0,6	31,0	35,500	21,200	0,900
35	72	17	1,1	0,6	31,0	31,000	20,800	0,880
	80	21	1,5	1,0	35,0	40,400	24,100	1,100
40	80	18	1,1	0,6	34,0	36,500	26,000	1,100
	90	23	1,5	1,0	39,0	50,000	32,500	1,370
45	85	19	1,1	0,6	37,0	38,000	28,500	1,220
	100	25	1,5	1,0	43,0	64,300	40,400	1,840
50	90	20	1,1	0,6	39,0	40,000	31,000	1,320
	110	27	2,0	1,0	47,0	75,000	51,000	2,160

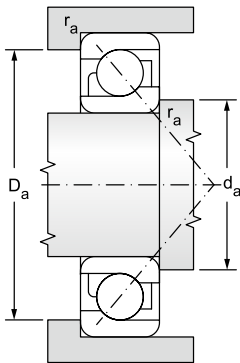

Limiting speed for lubrication with		Bearing designation	Abutment and Fillet Dimensions				Weight
Grease	Oil		d	d <sub>a</sub> min	D <sub>a</sub> max	r <sub>a</sub> max	
min <sup>-1</sup>			mm				kg
21000	28000	<b>7200BETNG</b>	10	14,5	25,5	0,6	0,0
19000	28000	<b>7200B</b>		14,5	25,8	0,6	0,0
19000	26000	<b>7201BETNG</b>	12	16,5	27,5	0,6	0,0
18000	26000	<b>7201B</b>		16,2	27,8	0,6	0,0
17000	24000	<b>7301B</b>		17,6	31,4	1,0	0,1
17000	20000	<b>7202AA</b>	15	19,0	31,0	0,6	0,1
17000	20000	<b>7202B</b>		19,0	31,0	0,6	0,1
14000	17000	<b>7302BETNG</b>		21,0	36,0	1,0	0,1
15000	20000	<b>7302B</b>		20,6	36,4	1,0	0,1
15000	20000	<b>7203B</b>	17	21,2	35,8	0,6	0,1
12600	15000	<b>7303AA</b>		23,0	41,0	1,0	0,1
12600	15000	<b>7303B</b>		23,0	41,0	1,0	0,1
12600	15000	<b>7303BTNG</b>		23,0	41,0	1,0	0,1
12600	15000	<b>7204AA</b>	20	25,0	42,0	1,0	0,1
12600	15000	<b>7204B</b>		25,0	42,0	1,0	0,1
12600	15000	<b>7204BTNG</b>		25,0	42,0	1,0	0,1
11000	16000	<b>7304B</b>		27,0	45,0	1,0	0,1
10000	15000	<b>7205B</b>	25	30,6	46,4	1,0	0,1
9400	11000	<b>7305B</b>		31,0	55,0	1,0	0,2
10000	12500	<b>7305BTNG</b>		31,0	55,0	1,0	0,2
8500	12000	<b>7206B</b>	30	35,6	56,4	1,0	0,2
8000	11000	<b>7306B</b>		37,0	65,0	1,0	0,3
8000	11000	<b>7207B</b>	35	42,0	65,0	1,0	0,3
7100	8400	<b>7307B</b>		42,0	71,0	1,5	0,5
7000	9500	<b>7208B</b>	40	47,0	73,0	1,0	0,4
6700	9000	<b>7308B</b>		49,0	81,0	1,5	0,6
6700	9000	<b>7209B</b>	45	52,0	78,0	1,0	0,4
5600	6700	<b>7309B</b>		52,0	91,0	1,5	0,9
6000	8000	<b>7210B</b>	50	57,0	83,0	1,0	0,5
5300	7000	<b>7310B</b>		61,0	99,0	2,0	1,0



Single row angular contact ball bearings

d = 50 to 110 mm

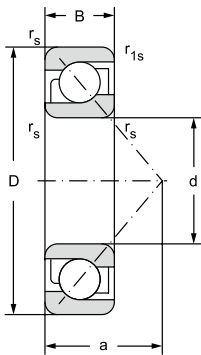

12.2.1

Main dimensions						Basic load rating		Fatigue load limit
d	D	B	r <sub>s</sub>	r <sub>1s</sub>	a	dynamic C <sub>r</sub>	static C <sub>0r</sub>	P <sub>H</sub>
			min	min				
mm						kN		kN
55	100	21	1,5	1,0	29,5	58,100	40,500	1,840
	100	21	1,5	1,0	43,0	49,000	40,000	1,660
	120	29	2,0	1,0	51,0	87,000	56,400	2,560
60	110	22	1,5	1,0	32,0	70,100	50,600	2,300
	110	22	1,5	1,0	47,0	61,000	50,000	2,120
	130	31	2,1	1,0	55,0	104,000	76,500	3,200
65	120	23	1,5	1,0	50,0	66,300	54,000	2,280
	140	33	2,1	1,0	60,0	116,000	86,500	3,650
70	125	24	1,5	1,0	53,0	75,000	64,000	2,700
	150	35	2,1	1,0	64,0	127,000	98,000	3,900
75	130	25	1,5	1,0	56,0	72,800	64,000	2,650
	160	37	2,1	1,0	68,0	132,000	104,000	4,150
80	140	26	2,0	1,0	59,0	85,000	75,000	3,050
	170	39	2,1	1,0	72,0	143,000	118,000	4,500
85	150	28	2,0	1,0	63,0	102,000	90,000	3,550
	180	41	3,0	1,0	76,0	156,000	132,000	4,900
90	160	30	2,0	1,0	67,0	116,000	104,000	4,000
	190	43	3,0	1,0	80,0	166,000	146,000	5,300
95	170	32	2,1	1,0	72,0	129,000	118,000	4,400
	200	45	3,0	1,0	84,0	180,000	163,000	5,700
100	180	34	2,1	1,0	76,0	143,000	134,000	4,750
	215	47	3,0	1,0	90,0	216,000	208,000	6,950
105	190	36	2,1	1,0	80,0	156,000	150,000	5,200
	225	49	3,0	1,0	94,0	228,000	228,000	7,500
110	200	38	2,1	1,0	84,0	170,000	166,000	4,700
	240	50	3,0	1,0	99,0	240,000	245,000	7,800
120	215	40	2,1	1,0	90,0	165,000	163,000	5,300
	260	55	3,0	1,0	107,0	238,000	250,000	7,650

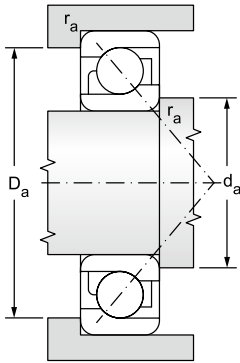

Limiting speed for lubrication with		Bearing designation	Abutment and Fillet Dimensions				Weight
Grease	Oil		d	d <sub>a</sub>	D <sub>a</sub>	r <sub>a</sub>	
min <sup>-1</sup>			mm				kg
5300	6300	<b>7211AA</b>	55	62,0	91,0	1,5	0,6
5600	7500	<b>7211B</b>		64,0	91,0	1,5	0,6
4700	5600	<b>7311B</b>		65,0	110,0	2,0	1,5
5000	6000	<b>7212AA</b>	60	67,0	101,0	1,5	0,8
5000	6700	<b>7212B</b>		69,0	101,0	1,5	0,8
4500	6000	<b>7312B</b>		72,0	118,0	2,0	1,7
4500	6000	<b>7213B</b>	65	74,0	111,0	1,5	1,0
4300	5600	<b>7313B</b>		77,0	128,0	2,0	2,1
4300	5600	<b>7214B</b>	70	79,0	116,0	1,5	1,1
3800	5000	<b>7314B</b>		82,0	138,0	2,0	2,6
4300	5600	<b>7215B</b>	75	84,0	121,0	1,5	1,2
3600	4800	<b>7315B</b>		87,0	148,0	2,0	3,1
3800	5000	<b>7216B</b>	80	91,0	129,0	2,0	1,4
3400	4500	<b>7316B</b>		92,0	158,0	2,0	3,6
3600	4800	<b>7217B</b>	85	96,0	139,0	2,0	1,8
3200	4300	<b>7317B</b>		99,0	166,0	2,5	4,3
3400	4500	<b>7218B</b>	90	101,0	149,0	2,0	2,1
3000	4000	<b>7318B</b>		104,0	176,0	2,5	5,0
3200	4300	<b>7219B</b>	95	107,0	158,0	2,0	2,7
2800	3800	<b>7319B</b>		109,0	186,0	2,5	5,8
3000	4000	<b>7220B</b>	100	112,0	168,0	2,0	3,3
2600	3600	<b>7320B</b>		114,0	201,0	2,5	7,2
2800	3800	<b>7221B</b>	105	117,0	178,0	2,0	3,8
2400	3400	<b>7321B</b>		119,0	211,0	2,5	8,5
2600	3600	<b>7222B</b>	110	122,0	188,0	2,0	4,6
2200	3200	<b>7322B</b>		124,0	226,0	2,5	9,7
2200	3200	<b>7224B</b>	120	132,0	203,0	2,0	5,9
1900	2800	<b>7324BM</b>		134,0	246,0	2,5	13,8



Single row angular contact ball bearings

d = 120 to 240 mm

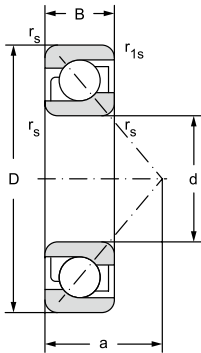

12.2.1

Main dimensions						Basic load rating		Fatigue load limit
d	D	B	r <sub>s</sub>	r <sub>1s</sub>	a	dynamic C <sub>r</sub>	static C <sub>0r</sub>	P <sub>H</sub>
			min	min				
mm						kN		kN
130	230	40	3,0	1,0	96,0	186,000	193,000	6,100
	280	58	4,0	1,5	115,0	276,000	305,000	9,000
140	250	42	3,0	1,0	103,0	199,000	212,000	6,400
	300	62	4,0	1,5	123,0	302,000	345,000	9,800
150	270	45	3,0	1,0	111,0	216,000	240,000	6,950
	320	65	4,0	1,5	131,0	332,000	390,000	10,800
160	290	48	3,0	1,0	118,0	255,000	300,000	8,500
	310	52	4,0	1,5	127,0	281,000	345,000	9,500
170	360	72	4,0	1,5	147,0	390,000	490,000	12,700
	320	52	4,0	1,5	131,0	291,000	375,000	10,000
180	380	75	4,0	2,0	156,0	410,000	540,000	13,700
	340	55	4,0	1,5	139,0	307,000	405,000	10,400
190	400	78	5,0	2,0	164,0	442,000	600,000	14,600
	360	58	4,0	1,5	146,0	325,000	430,000	11,000
200	420	80	5,0	2,0	170,0	462,000	655,000	15,600
	400	65	4,0	1,5	164,0	390,000	560,000	13,400
220	440	72	4,0	1,5	180,0	364,000	540,000	12,500



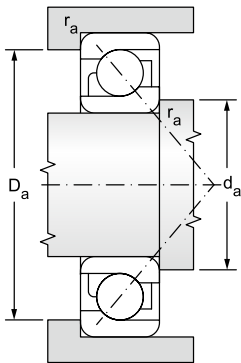

Limiting speed for lubrication with		Bearing designation	Abutment and Fillet Dimensions				Weight
Grease	Oil		d	d <sub>a</sub> min	D <sub>a</sub> max	r <sub>a</sub> max	
min <sup>-1</sup>			mm				kg
1900	2800	<b>7226BM</b>	130	144,0	216,0	2,5	6,8
1800	2600	<b>7326BM</b>		147,0	263,0	3,0	17,1
1800	2600	<b>7228BM</b>	140	154,0	236,0	2,5	8,6
1700	2400	<b>7328BM</b>		157,0	283,0	3,0	21,3
1700	2400	<b>7230BM</b>	150	164,0	256,0	2,5	10,8
1600	2200	<b>7330BM</b>		167,0	303,0	3,0	25,0
1600	2200	<b>7232BM</b>	160	174,0	276,0	2,5	13,6
1600	2200	<b>7234BM</b>	170	187,0	293,0	3,0	16,7
1400	1900	<b>7334BM</b>		187,0	343,0	3,0	34,6
1500	2000	<b>7236BM</b>	180	197,0	303,0	3,0	17,6
1300	1800	<b>7336BM</b>		197,0	363,0	3,0	40,0
1400	1900	<b>7238BM</b>	190	207,0	323,0	3,0	21,9
1200	1700	<b>7338BM</b>		210,0	380,0	4,0	48,3
1200	1700	<b>7240BM</b>	200	217,0	343,0	3,0	25,0
1100	1600	<b>7340BM</b>		220,0	400,0	4,0	52,8
1100	1600	<b>7244BM</b>	220	237,0	383,0	3,0	35,2
1000	1500	<b>7248BM</b>	240	257,0	423,0	3,0	49,0



Single row high-speed angular contact ball bearings d = 7 to 130 mm

d = 7 to 17 mm

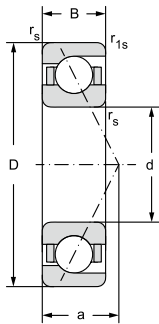

12.2.2

		Main dimensions				Basic load rating		Fatigue load limit
d	D	B	r <sub>s</sub>	r <sub>1s</sub>	a	dynamic C <sub>r</sub>	static C <sub>or</sub>	P <sub>u</sub>
			min	min				
			mm			kN		kN
7	22	7	0,3	0,15	5,000	2,364	0,90	0,041
9	26	8	0,6	0,30	5,500	3,891	1,64	0,075
10	30	9	0,6	0,30	6,000	5,335	2,29	0,104
	30	9	0,6	0,30	6,500	7,124	2,90	0,132
	30	9	0,6	0,30	7,000	7,729	3,28	0,149
	30	9	0,6	0,30	7,180	4,387	2,10	0,095
	30	9	0,6	0,30	9,000	7,529	3,20	0,145
	30	9	0,6	0,30	9,160	4,181	2,00	0,091
12	32	10	0,6	0,30	7,000	5,880	2,65	0,120
	32	10	0,6	0,30	7,500	7,980	3,46	0,157
	32	10	0,6	0,30	8,000	8,622	3,89	0,177
	32	10	0,6	0,30	10,000	8,275	3,78	0,172
	32	10	0,6	0,30	10,500	7,505	3,21	0,146
15	32	9	0,3	0,15	7,648	4,695	2,30	0,105
	32	9	0,3	0,15	9,980	6,622	3,20	0,145
	32	9	0,3	0,15	9,980	4,490	2,20	0,100
	32	9	0,3	0,30	7,648	6,955	3,50	0,159
	35	11	0,6	0,30	7,500	6,940	3,45	0,157
	35	11	0,6	0,30	8,000	8,855	4,18	0,190
	35	11	0,6	0,30	11,000	9,078	4,44	0,202
	35	11	0,6	0,60	9,000	9,483	4,59	0,209
17	35	10	0,3	0,15	8,480	6,235	3,40	0,155
	35	10	0,3	0,15	16,780	7,562	4,25	0,193
	35	10	0,3	0,15	16,780	5,916	3,00	0,136
	35	10	0,3	0,30	8,480	7,896	4,45	0,202
	40	12	0,6	0,30	8,500	8,362	4,25	0,193
	40	12	0,6	0,30	9,000	10,904	5,29	0,240
	40	12	0,6	0,30	13,000	11,182	5,62	0,255
	40	12	0,6	0,60	10,000	11,631	5,82	0,265

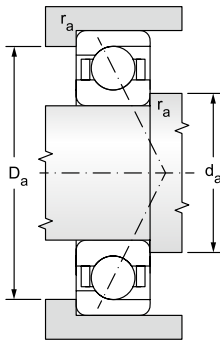

\*\* Bearings in the new standard NEW FORCE

\*\*\* Separable bearing dedicated to separable arrangements of textile spindles parts

Limiting speed for lubrication with		Axial prestress of associated bearings			Bearing designation	Weight
Grease	Oil	L	M	S		
min <sup>-1</sup>		N				kg
94000	140000				<b>A727CBTA**</b>	0,013
71000	106000				<b>A729CBTA**</b>	0,020
60000	89000	20	70	140	<b>B7200CBTB**</b>	0,027
42000	63000	33	105	213	<b>B7200CATB**</b>	0,028
56000	85000	45	140	280	<b>B7200CTA**</b>	0,030
65000	100000	15	60	130	<b>CB7200CTA**</b>	0,028
50000	75000	65	240	450	<b>B7200ATA**</b>	0,030
55000	85000	22	80	195	<b>CB7200ATA**</b>	0,028
56000	84000	22	77	154	<b>B7201CBTB**</b>	0,035
38000	56000	37	118	235	<b>B7201CATB**</b>	0,036
50000	75000	50	160	320	<b>B7201CTA**</b>	0,037
45000	67000	75	270	540	<b>B7201ATA**</b>	0,037
33000	50000				<b>AC7201ATA***</b>	0,036
55000	85000	11	52	115	<b>CB7002CTA**</b>	0,043
40000	65000	37	155	355	<b>B7002ATA**</b>	0,043
50000	72000	18	68	170	<b>CB7002ATA**</b>	0,043
45000	70000	30	110	225	<b>B7002CTA**</b>	0,043
50000	75000	25	90	180	<b>B7202CBTB**</b>	0,042
33000	50000	41	132	264	<b>B7202CATB**</b>	0,043
40000	60000	80	290	590	<b>B7202ATA**</b>	0,045
45000	67000	55	170	350	<b>B7202CTA**</b>	0,045
55000	80000	18	75	165	<b>CB7003CTA**</b>	0,039
38000	56000	50	190	420	<b>B7003ATA**</b>	0,039
45000	65000	30	100	230	<b>CB7003ATA**</b>	0,039
44000	67500	40	150	260	<b>B7003CTA**</b>	0,039
45000	67000	31	109	219	<b>B7203CBTB**</b>	0,060
28000	42000	51	163	326	<b>B7203CATB**</b>	0,061
36000	53000	100	360	730	<b>B7203ATA**</b>	0,064
38000	56000	70	210	430	<b>B7203CTA**</b>	0,064



Single row high-speed angular contact ball bearings

d = 20 to 35 mm

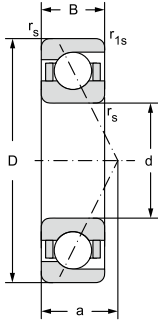

12.2.2

		Main dimensions				Basic load rating		Fatigue load limit
d	D	B	r <sub>s</sub>	r <sub>1s</sub>	a	dynamic C <sub>r</sub>	static C <sub>or</sub>	P <sub>u</sub>
		min		min				
		mm				kN		kN
20	42	12	0,6	0,30	9,150	11,899	6,20	0,282
	42	12	0,6	0,30	9,150	7,940	4,20	0,191
	42	12	0,6	0,30	12,220	11,707	6,00	0,273
	42	12	0,6	0,30	12,220	7,740	4,00	0,182
	47	14	1,0	0,60	10,000	10,224	5,54	0,252
	47	14	1,0	0,60	10,500	14,572	7,32	0,333
	47	14	1,0	0,60	12,000	15,685	8,06	0,366
	47	14	1,0	0,60	14,000	14,952	7,77	0,353
	47	14	1,0	0,60	15,000	13,897	6,99	0,318
25	47	12	0,6	0,30	10,320	13,750	8,60	0,391
	47	12	0,6	0,30	10,320	9,532	5,70	0,259
	47	12	0,6	0,30	13,890	13,186	8,20	0,373
	47	12	0,6	0,30	13,890	9,121	5,60	0,255
	52	15	1,0	0,60	11,000	14,091	7,96	0,362
	52	15	1,0	0,60	11,500	15,921	8,63	0,392
	52	15	1,0	0,60	13,000	17,679	10,28	0,467
	52	15	1,0	0,60	16,000	16,917	9,81	0,446
	52	15	1,0	0,60	17,000	14,895	8,15	0,370
30	55	13	1,0	0,60	12,200	16,234	10,30	0,468
	55	13	1,0	0,60	12,200	11,331	7,20	0,327
	55	13	1,0	0,60	25,850	15,515	10,10	0,459
	55	13	1,0	0,60	25,850	10,817	6,90	0,314
	62	16	1,0	0,60	12,000	18,020	10,72	0,487
	62	16	1,0	0,60	13,000	22,072	12,42	0,565
	62	16	1,0	0,60	14,000	24,734	14,72	0,669
	62	16	1,0	0,60	19,000	20,877	11,58	0,526
	62	16	1,0	0,60	19,000	23,483	14,07	0,640
35	62	14	1,0	0,60	13,490	20,680	14,40	0,655
	62	14	1,0	0,60	13,490	14,298	10,00	0,455
	62	14	1,0	0,60	18,500	18,476	12,05	0,548
	62	14	1,0	0,60	28,980	20,097	13,25	0,602
	62	14	1,0	0,60	28,980	13,910	9,40	0,427
	72	17	1,1	0,60	10,000	29,131	17,40	0,791
	72	17	1,1	0,60	13,000	22,523	14,34	0,652
	72	17	1,1	0,60	14,000	31,042	18,60	0,845
	72	17	1,1	0,60	15,000	32,929	20,29	0,922
	72	17	1,1	0,60	16,000	32,669	20,04	0,911
	72	17	1,1	0,60	21,000	31,002	19,10	0,868

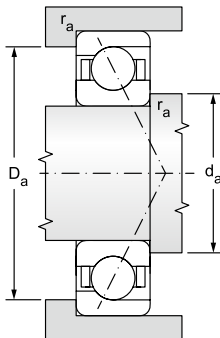

\*\* Bearings in the new standard NEW FORCE

Limiting speed for lubrication with		Axial prestress of associated bearings			Bearing designation	Weight
Grease	Oil	L	M	S		
min <sup>-1</sup>		N				kg
39000	57000	55	180	400	<b>B7004CTA**</b>	0,066
45000	65000	25	100	200	<b>CB7004CTA**</b>	0,066
35000	50000	75	290	645	<b>B7004ATA**</b>	0,066
35000	55000	30	120	300	<b>CB7004ATA**</b>	0,066
40000	60000	38	134	268	<b>B7204CBTB**</b>	0,098
25000	38000	68	218	437	<b>B7204CATB**</b>	0,100
32000	48000	90	290	580	<b>B7204CTA**</b>	0,10
30000	45000	140	490	950	<b>B7204ATA**</b>	0,10
22000	33000	156	455	910	<b>B7204AATB**</b>	0,10
35000	50000	65	220	470	<b>B7005CTA**</b>	0,080
40000	55000	30	120	250	<b>CB7005CTA**</b>	0,080
30000	45000	100	360	740	<b>B7005ATA**</b>	0,080
35000	50000	35	180	410	<b>CB7005ATA**</b>	0,080
33000	50000	53	183	367	<b>B7205CBTB**</b>	0,12
22000	33000	74	237	474	<b>B7205CATB**</b>	0,12
28000	43000	100	330	650	<b>B7205CTA**</b>	0,13
26000	40000	155	550	1100	<b>B7205ATA**</b>	0,13
20000	30000	167	488	977	<b>B7205AATB**</b>	0,12
26000	40000	75	260	555	<b>B7006CTA**</b>	0,12
30000	45000	37	140	300	<b>CB7006CTA**</b>	0,12
24000	38000	105	405	885	<b>B7006ATA**</b>	0,12
28000	43000	40	200	450	<b>CB7006ATA**</b>	0,12
28000	42000	67	235	470	<b>B7206CBTB**</b>	0,18
20000	30000	102	325	655	<b>B7206CATB**</b>	0,19
24000	38000	140	450	910	<b>B7206CTA**</b>	0,19
17000	25000	233	679	1740	<b>B7206AATB**</b>	0,19
22000	36000	220	770	1530	<b>B7206ATA**</b>	0,19
22000	36000	100	330	710	<b>B7007CTA**</b>	0,16
30000	45000	48	180	380	<b>CB7007CTA**</b>	0,16
9400	11000	207	605	1210	<b>B7007AATB**</b>	0,15
20000	32000	140	530	1150	<b>B7007ATA**</b>	0,16
25000	40000	60	270	600	<b>CB7007ATA**</b>	0,16
13000	20000	326	952	1900	<b>B7207AATB**</b>	0,28
25000	38000	84	280	588	<b>B7207CBTB**</b>	0,27
16000	24000	144	462	925	<b>B7207CATB**</b>	0,28
16000	24000	153	490	981	<b>B7207CAMB**</b>	0,32
20000	34000	185	600	1200	<b>B7207CTA**</b>	0,28
19000	32000	290	1010	2010	<b>B7207ATA**</b>	0,28



Single row high-speed angular contact ball bearings

d = 40 to 55 mm

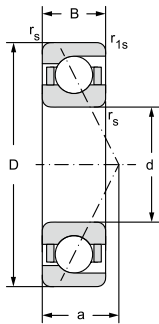

12.2.2

		Main dimensions				Basic load rating		Fatigue load limit
d	D	B	r <sub>s</sub>	r <sub>1s</sub>	a	dynamic C <sub>r</sub>	static C <sub>or</sub>	P <sub>u</sub>
		min		min				
		mm				kN		kN
40	68	15	1,0	0,60	14,730	21,960	16,10	0,732
	68	15	1,0	0,60	14,730	15,151	11,00	0,500
	68	15	1,0	0,60	20,100	20,933	15,20	0,691
	68	15	1,0	0,60	20,100	14,111	10,60	0,482
	68	15	1,0	0,60	20,500	19,859	14,13	0,642
	80	18	1,1	0,60	14,000	26,240	17,30	0,786
	80	18	1,1	0,60	15,500	39,375	23,77	1,080
	80	18	1,1	0,60	17,000	41,450	26,02	1,183
	80	18	1,1	0,60	23,000	39,759	24,90	1,132
45	68	12	0,6	0,30	13,000	16,018	12,60	0,573
	68	12	0,6	0,30	13,000	11,502	9,10	0,414
	68	12	0,6	0,30	18,190	15,137	12,00	0,545
	68	12	0,6	0,30	18,190	10,777	8,80	0,400
	75	16	1,0	0,60	0,030	27,020	20,40	0,927
	75	16	1,0	0,60	16,030	18,921	14,30	0,650
	75	16	1,0	0,60	21,980	25,680	19,30	0,877
	75	16	1,0	0,60	21,980	17,993	13,50	0,614
	85	19	1,1	0,60	15,000	30,327	20,31	0,923
	85	19	1,1	0,60	16,500	39,540	24,61	1,119
	85	19	1,1	0,60	18,000	43,841	28,81	1,310
	85	19	1,1	0,60	25,000	41,893	27,54	1,252
50	80	16	1,0	0,60	15,800	24,133	18,52	0,842
	80	16	1,0	0,60	19,730	27,716	21,80	0,991
	80	16	1,0	0,60	19,730	19,740	15,30	0,695
	80	16	1,0	0,60	23,150	26,273	20,80	0,945
	80	16	1,0	0,60	23,150	18,708	14,60	0,664
	90	20	1,1	0,60	16,000	34,593	23,56	1,071
	90	20	1,1	0,60	17,500	41,758	27,26	1,239
	90	20	1,1	0,60	19,000	45,871	31,73	1,442
	90	20	1,1	0,60	26,000	39,229	25,92	1,178
	90	20	1,1	0,60	26,000	43,970	30,08	1,367
55	90	18	1,1	0,60	26,500	33,314	25,38	1,154
	100	21	1,5	1,00	17,000	41,229	29,12	1,324
	100	21	1,5	1,00	18,500	51,719	34,50	1,568
	100	21	1,5	1,00	21,000	56,847	39,92	1,815
	100	21	1,5	1,00	29,000	54,288	38,23	1,738

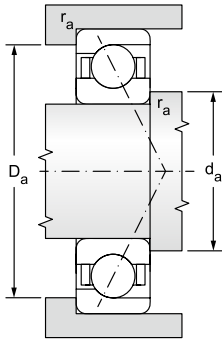

\*\* Bearings in the new standard NEW FORCE

Limiting speed for lubrication with		Axial prestress of associated bearings			Bearing designation	Weight
Grease	Oil	L	M	S		
min <sup>-1</sup>		N				kg
20000	34000	105	350	755	<b>B7008CTA**</b>	0,19
26000	40000	50	190	410	<b>CB7008CTA**</b>	0,19
19000	30000	150	560	1200	<b>B7008ATA**</b>	0,19
22000	35000	60	280	630	<b>CB7008ATA**</b>	0,19
8400	10000	222	645	1290	<b>B7008AATB**</b>	0,19
22000	33000	98	343	686	<b>B7208CBTB**</b>	0,34
13000	20000	180	587	1170	<b>B7208CATB**</b>	0,35
18000	30000	235	770	1540	<b>B7208CTA**</b>	0,35
17000	28000	370	1100	2500	<b>B7208ATA**</b>	0,35
20000	32000	90	320	535	<b>B71909CTA**</b>	0,13
25000	38000	35	140	310	<b>CB71909CTA**</b>	0,11
18000	30000	100	390	840	<b>B71909ATA**</b>	0,13
22000	35000	70	200	450	<b>CB71909ATA**</b>	0,11
18000	30000	140	470	935	<b>B7009CTA**</b>	0,26
23000	37000	70	250	530	<b>CB7009CTA**</b>	0,23
17000	28000	195	750	1500	<b>B7009ATA**</b>	0,26
21000	33000	85	370	840	<b>CB7009ATA**</b>	0,23
20000	30000	113	396	792	<b>B7209CBTB**</b>	0,38
12600	19000	184	590	1175	<b>B7209CATB**</b>	0,38
17000	28000	250	810	1630	<b>B7209CTA**</b>	0,39
15000	24000	390	1200	2710	<b>B7209ATA**</b>	0,39
9500	11000	270	793	1580	<b>B7010AATB**</b>	0,25
17000	28000	150	510	965	<b>B7010CTA**</b>	0,25
22000	35000	75	280	580	<b>CB7010CTA**</b>	0,21
15000	24000	210	750	1550	<b>B7010ATA**</b>	0,25
18000	30000	90	400	880	<b>CB7010ATA**</b>	0,21
18000	27000	129	450	905	<b>B7210CBTB**</b>	0,43
12000	18000	195	623	1245	<b>B7210CATB**</b>	0,44
16000	26000	260	850	1710	<b>B7210CTA**</b>	0,45
10600	16000	438	1275	2550	<b>B7210AATB**</b>	0,45
14000	20000	400	1400	2810	<b>B7210ATA**</b>	0,45
6300	7500	371	1080	2160	<b>B7011AATB**</b>	0,40
17000	25000	153	538	1075	<b>B7211CBTB**</b>	0,57
11000	17000	241	771	1540	<b>B7211CATB**</b>	0,58
14000	22000	320	1010	2100	<b>B7211CTA**</b>	0,59
13000	20000	500	1710	3500	<b>B7211ATA**</b>	0,59



Single row high-speed angular contact ball bearings

d = 60 to 80 mm

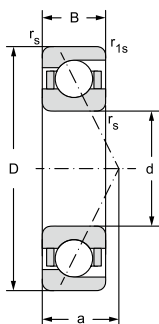

12.2.2

Main dimensions						Basic load rating		Fatigue load limit
d	D	B	r <sub>s</sub>	r <sub>1s</sub>	a	dynamic	static	P <sub>u</sub>
			min	min		C <sub>r</sub>	C <sub>or</sub>	
mm						kN		kN
60	95	18	1,1	1,00	21,660	38,610	32,00	1,455
	95	18	1,1	1,00	21,660	27,085	22,40	1,018
	95	18	1,1	1,00	27,100	36,807	30,40	1,382
	95	18	1,1	1,00	27,100	25,810	21,30	0,968
	110	22	1,5	1,00	18,000	47,450	33,80	1,536
	110	22	1,5	1,00	20,000	64,377	42,60	1,936
	110	22	1,5	1,00	22,000	70,784	49,07	2,230
	110	22	1,5	1,00	31,000	67,627	47,07	2,140
65	120	23	1,5	1,00	32,000	60,741	39,96	1,816
	120	23	1,5	1,00	21,500	78,185	54,78	2,490
	120	23	1,5	1,00	24,000	81,130	58,70	2,668
	120	23	1,5	1,00	33,000	76,670	56,06	2,548
70	110	20	1,1	0,60	22,060	53,288	45,00	2,045
	110	20	1,1	0,60	22,060	36,807	31,20	1,418
	110	20	1,1	0,60	30,990	50,628	42,90	1,950
	110	20	1,1	0,60	32,000	45,430	36,46	1,657
	125	24	1,5	1,00	20,500	64,709	47,66	2,166
	125	24	1,5	1,00	22,500	84,775	60,13	2,733
	125	24	1,5	1,00	25,000	87,597	64,55	2,934
	125	24	1,5	1,00	30,990	35,567	21,80	0,991
75	125	24	1,5	1,00	35,000	83,397	61,56	2,798
	130	25	1,5	1,00	23,500	84,948	61,39	2,756
	130	25	1,5	1,00	26,000	87,285	65,44	2,938
	130	25	1,5	1,00	36,000	83,103	62,52	2,807
	130	25	1,5	1,00	37,500	82,540	62,49	2,806
80	130	25	1,5	1,00	37,500	78,887	58,32	2,618
	125	22	1,1	0,60	22,000	61,117	50,01	2,245
	125	22	1,1	0,60	24,730	66,963	57,50	2,582
	125	22	1,1	0,60	24,730	46,894	40,20	1,805
	125	22	1,1	0,60	34,900	64,095	55,10	2,474
	125	22	1,1	0,60	34,900	44,874	38,60	1,733
	125	22	1,1	0,60	36,000	59,265	49,44	2,220
	140	26	2,0	1,00	24,500	99,345	73,05	3,166
	140	26	2,0	1,00	28,000	102,080	77,56	3,361
	140	26	2,0	1,00	39,000	97,328	73,95	3,205
	140	26	2,0	1,00	40,000	92,645	68,04	2,949



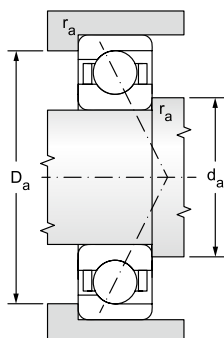

\*\* Bearings in the new standard NEW FORCE

Limiting speed for lubrication with		Axial prestress of associated bearings			Bearing designation	Weight
Grease	Oil	L	M	S		
min <sup>-1</sup>		N				kg
14000	22000	210	700	1305	<b>B7012CTA**</b>	0,41
18000	30000	100	360	780	<b>CB7012CTA**</b>	0,35
13000	20000	290	1000	2100	<b>B7012ATA**</b>	0,41
15000	25000	130	540	1150	<b>CB7012ATA**</b>	0,35
15000	22000	172	602	1200	<b>B7212CBTB**</b>	0,74
10000	15000	291	932	1860	<b>B7212CATB**</b>	0,75
13000	20000	380	1200	2500	<b>B7212CTA**</b>	0,75
12000	19000	610	2130	4200	<b>B7212ATA**</b>	0,75
8900	13000	657	1915	3830	<b>B7212AATB**</b>	0,76
8900	13000	352	1128	2250	<b>B7213CATB**</b>	0,99
12000	19000	440	1400	2900	<b>B7213CTA**</b>	1,00
11000	18000	700	2410	4810	<b>B7213ATA**</b>	1,00
13000	19000	280	930	1825	<b>B7014CTA**</b>	0,60
15000	25000	140	500	1020	<b>CB7014CTA**</b>	0,50
11000	17000	390	1390	2910	<b>B7014ATA**</b>	0,60
7900	12000	493	1140	2050	<b>B7014AATB**</b>	0,60
12600	19000	234	820	1640	<b>B7214CBTB**</b>	1,04
7900	12000	373	1190	2350	<b>B7214CATB**</b>	1,07
11000	18000	480	1540	3170	<b>B7214CTA**</b>	1,09
14000	20000	180	720	1600	<b>CB7014ATA**</b>	0,50
10000	17000	760	2620	5300	<b>B7214ATA**</b>	1,09
7500	11000	383	1250	2450	<b>B7215CATB**</b>	1,16
11000	18000	480	1560	3170	<b>B7215CTA**</b>	1,17
9500	16000	760	2640	5210	<b>B7215ATA**</b>	1,17
4200	5000	898	2620	5240	<b>B7215AAMB**</b>	1,39
6700	10000	858	2500	500	<b>B7215AATB**</b>	1,26
7500	11000	276	885	1770	<b>B7016CATB**</b>	0,84
10000	18000	350	1140	2290	<b>B7016CTA**</b>	0,85
14000	22000	180	620	1350	<b>CB7016CTA**</b>	0,71
9000	15000	500	1800	3700	<b>B7016ATA**</b>	0,85
13000	20000	250	950	1950	<b>CB7016ATA**</b>	0,71
6700	10000	267	855	1710	<b>B7016AATB**</b>	0,85
6700	10000	447	1432	2860	<b>B7216CATB**</b>	1,41
10000	17000	560	1840	3700	<b>B7216CTA**</b>	1,43
9000	15000	880	3050	6110	<b>B7216ATA**</b>	1,43
6300	9400	1008	2940	5880	<b>B7216AATB**</b>	1,42



Single row high-speed angular contact ball bearings

d = 85 to 130 mm

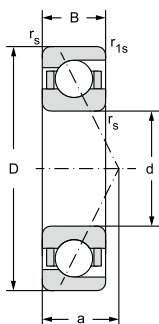

12.2.2

		Main dimensions				Basic load rating		Fatigue load limit
d	D	B	r <sub>s</sub>	r <sub>1s</sub>	a	dynamic C <sub>r</sub>	static C <sub>or</sub>	P <sub>u</sub>
		min		min				
		mm				kN		kN
85	130	22	1,1	0,60	25,400	68,386	58,70	2,573
	130	22	1,1	0,60	25,400	47,914	41,40	1,815
	130	22	1,1	0,60	30,060	67,847	58,20	2,552
	130	22	1,1	0,60	30,060	47,558	40,70	1,784
	130	22	1,1	0,60	37,000	60,265	52,69	2,310
	130	28	1,1	0,60	37,000	62,314	55,33	2,426
	150	28	2,0	1,00	26,500	111,477	86,08	3,610
	150	28	2,0	1,00	30,000	115,662	88,55	3,713
90	140	24	1,5	1,00	24,000	74,528	62,47	2,648
	140	24	1,5	1,00	27,410	81,622	72,40	3,069
	140	24	1,5	1,00	27,410	57,187	57,90	2,454
	140	24	1,5	1,00	38,810	77,461	69,00	2,925
	140	24	1,5	1,00	38,810	54,305	40,50	1,717
	140	24	1,5	1,00	40,000	72,276	61,75	2,617
100	180	34	2,1	1,10	51,000	156,339	120,96	4,732
	150	24	1,5	0,60	28,750	89,607	80,80	3,285
	150	24	1,5	0,60	28,750	61,827	55,70	2,265
	150	24	1,5	0,60	41,150	84,040	76,40	3,106
	150	24	1,5	0,60	41,150	58,023	52,70	2,143
	180	34	2,1	1,10	35,760	105,682	86,00	3,304
	180	34	2,1	1,10	36,000	171,671	136,01	5,225
	180	34	2,1	1,10	49,770	98,808	83,00	3,189
110	140	16	1,0	0,60	24,700	44,428	49,60	2,017
	140	16	1,0	0,60	34,000	42,287	46,30	1,882
120	180	28	2,0	1,00	30,000	112,019	103,66	3,847
	180	28	2,0	1,00	34,100	114,338	107,80	4,001
	180	28	2,0	1,00	34,100	78,921	75,40	2,798
	180	28	2,0	1,00	48,980	107,543	102,10	3,789
	180	28	2,0	1,00	48,980	74,299	71,50	2,654
	180	28	2,0	1,00	50,500	106,191	101,28	3,759
130	165	11	1,0	0,50	41,500	14,903	19,10	0,715

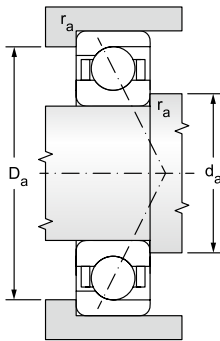

\*\* Bearings in the new standard NEW FORCE

Limiting speed for lubrication with		Axial prestress of associated bearings			Bearing designation	Weight
Grease	Oil	L	M	S		
min <sup>-1</sup>		N				kg
10000	17000	380	1240	2350	<b>B7017CTA**</b>	0,91
12000	19000	190	640	1400	<b>CB7017CTA**</b>	0,77
9000	15000	540	1870	3900	<b>B7017ATA**</b>	0,91
10000	18000	260	1000	2100	<b>CB7017ATA**</b>	0,77
4200	5000	653	1900	3800	<b>B7017AATA**</b>	0,91
6300	9400	675	1970	3940	<b>B7017AAMB**</b>	1,06
6300	9400	502	1608	3210	<b>B7217CATB**</b>	1,80
9000	15000	630	2010	4150	<b>B7217CTA**</b>	1,82
8000	13000	1000	3450	6910	<b>B7217ATA**</b>	1,82
6000	8900	1310	3290	6590	<b>B7217AATB**</b>	1,82
6300	9400	338	1080	2160	<b>B7018CATB**</b>	1,15
10000	16000	450	1450	2800	<b>B7018CTA**</b>	1,15
12000	19000	230	760	1590	<b>CB7018CTA**</b>	0,97
9000	15000	620	2200	4580	<b>B7018ATA**</b>	1,15
10000	17000	315	1150	2550	<b>CB7018ATA**</b>	0,97
4000	4700	783	2280	4570	<b>B7018AATB**</b>	1,16
5300	7900	1690	4930	9870	<b>B7220AATB**</b>	3,32
8000	14000	470	1520	3070	<b>B7020CTA**</b>	1,29
11000	18000	235	815	1700	<b>CB7020CTA**</b>	1,10
7000	12000	680	2340	4950	<b>B7020ATA**</b>	1,29
9000	15000	335	1265	2710	<b>CB7020ATA**</b>	1,10
10000	15000	450	1460	2950	<b>CB7220CTA**</b>	2,89
7500	12000	940	3100	6220	<b>B7220CTA**</b>	3,32
8000	13000	640	2200	5580	<b>CB7220ATA**</b>	2,89
6700	10000	1480	5200	10100	<b>B7220ATA**</b>	3,32
8000	13000	200	700	1500	<b>B71822CTA**</b>	0,50
7000	11000	350	900	2000	<b>B71822ATA**</b>	0,50
5000	7500	505	1617	3230	<b>B7024CATB**</b>	2,10
7000	10000	670	2000	4100	<b>B7024CTA**</b>	2,10
9000	14000	320	1100	2220	<b>CB7024CTA**</b>	1,85
6000	9000	950	3200	6550	<b>B7024ATA**</b>	2,10
8000	12000	450	1680	3550	<b>CB7024ATA**</b>	1,85
3000	3500	1153	3363	6727	<b>B7024AATB**</b>	2,09
3200	3800				<b>B70826AAMB**</b>	0,64

## DOUBLE ROW ANGULAR CONTACT BALL BEARINGS

### Design

Double row angular contact ball bearings in fact correspond with associated pair of single row angular contact ball bearings in configuration "O". At the same size (d and D), associated pair has total width smaller.

They can transfer radial load and also double direction axial loads. Bearings allow design of rigid location and transfer also overturning torques. Standard offer of Dunlop BTL double row angular contact ball bearings (fig. 12.2.4) includes:

- Bearings in standard version
- Bearings with seals

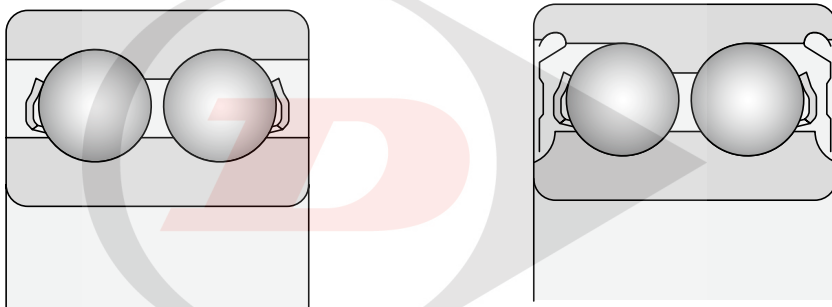

Fig. 12.2.4

### Bearings in standard version

Dunlop BTL double row angular contact ball bearings in fact of 32 and 33 series produced in the NEW FORCE standard are marked with \*\* in the table section. The bearings feature optimised inner design. They have a filling slot on one side. If axial forces acting in one direction prevail, the bearing should be mounted so that these forces do not act against the filling slot.

The bearings have contact angle of  $32^\circ$ . Due to this design they are able to transfer axial load and higher overturning torques in axial plane so if there is a lack of space, only one bearing is enough for location of the rotary part.



## Bearings with seals

The bearings have a design with contact angle of 25°. The 32 and 33 series bearings with sealing 2RS are filled with high quality lithium grease Shell Gadus F2V100-3. This grease features good anticorrosive properties, and can be therefore used in temperature ranging between -30 and 20 °C. The viscosity of basic oil compound is 100 mm<sup>2</sup>/s at 40 °C or 10. mm<sup>2</sup>/s at 100 °C.

## Main dimensions

The main dimensions of the bearings comply with the ISO 15 standard, with the exception of the width of bearing 3200X. Dimensions of individual bearings are stated in the table section of the publication.

## Designation

The system of designating the bearings in basic version is stated in the table section of the publication. Difference from the basic design is identified with additional characters as advised in chapter 7.6.

## Cages

Double row angular contact ball bearings have cages pressed of steel plate (fig. 12.2.5). The design not identified. Bearings can be also supplied with polyamide cage PA6 or PA66, designated TNG (fig. 12.2.6)

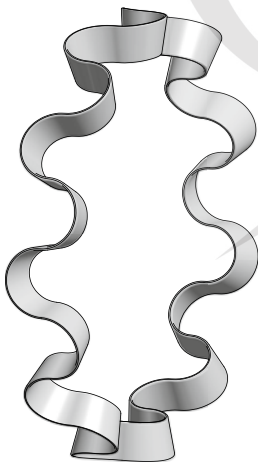

Fig. 12.2.5

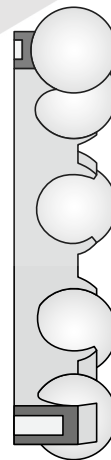

Fig. 12.2.6



## Accuracy

Bearings are usually made in normal accuracy level P0 whilst this symbol is not presented. For more exacting locations bearings in higher accuracy level P6 are made.

The limit values of bearing dimension and run accuracy are stated in charts 7.2 to 7.4, and comply with the standard ISO 492.

## Axial clearance

Commonly produced bearings feature normal axial clearance that is not identified. Special locations require bearings with reduced C2 and increased axial clearance C3 and C4. Axial clearance values are stated in chart 7.17b.

## Misalignment

Bearings form very rigid locations and are extremely sensitive to misalignment of rings caused by assembly inaccuracies. Any misalignment of bearing rings in operation will also increase significantly the noise level and shorten the service life of the bearing.

## Minimum load

Bearings with point or line contact must be exposed to certain minimum load in order to ensure their proper operation. This applies also to double row ball bearings working at high revolutions where high acceleration or sudden changes of acting load occur. Under such conditions the inertial forces of balls and cages as well as the friction in the lubricant may have negative impact on the conditions of rolling, which might cause damage to the rolling elements and raceways due to slipping. The required minimum radial load for double row angular contact ball bearings can be estimated by the below relation:

$$F_{rm} = k_r \cdot \left( \frac{vn}{1000} \right)^{\frac{2}{3}} \cdot \left( \frac{d_m}{100} \right)^2$$

$F_{rm}$  . . . . . is minimum radial load (kN)

$k_r$  . . . . . is coefficient of minimum radial load

. . . . . 0.06 for bearings of series 32

. . . . . 0.07 for bearings of series 33

$v$  . . . . . oil viscosity at service temperature [mm<sup>2</sup>/s]

$n$  . . . . . revolutions [min<sup>-1</sup>]

$d_m$  . . . . . mean diameter of bearing, i.e. 0.5 (d + D), [mm]



At start-up in low temperatures, or in use of grease with high viscosity even higher minimum load may be necessary. The weight of components captured by bearing, along with external forces is often higher than the minimum load required. If this is not the case, an additional radial load must act on double row angular contact ball bearing.

### Equivalent radial dynamic load

$$P_r = F_r + 0.73F_a \quad \text{for } F_a / F_r \leq 0.86$$

$$P_r = 0.62F_r + 1.17F_a \quad \text{for } F_a / F_r > 0.86$$

### Equivalent radial static load

$$P_{or} = F_r + 0.63F_a$$

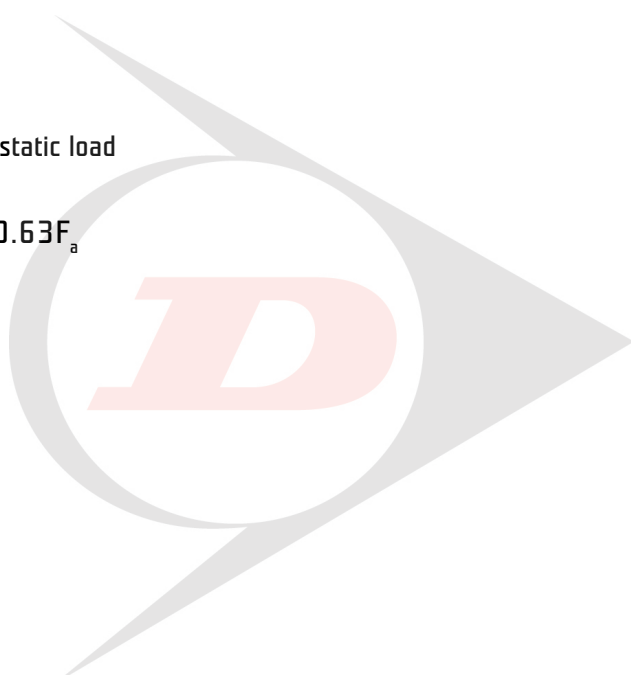



Double row angular contact ball bearings d = 10 to 110 mm

d = 10 to 70 mm

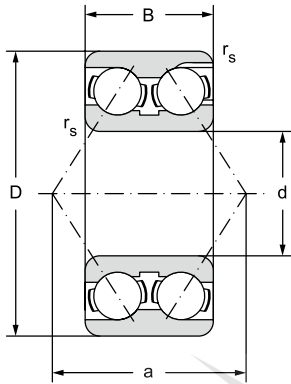

12.2.3

Main dimensions					Basic load rating		Fatigue load limit
d	D	B	r <sub>s</sub>	a	dynamic (C <sub>r</sub> )	static (C <sub>or</sub> )	P <sub>u</sub>
mm					kN		kN
10	30	14,0	0,6	20,0	9,253	5,840	0,265
	30	14,3	0,6	20,0	9,253	5,840	0,265
12	32	15,9	0,6	22,0	11,050	7,080	0,322
15	35	15,9	0,6	23,0	10,381	7,500	0,341
	42	19,0	1,0	27,0	17,369	11,900	0,541
17	40	17,5	0,6	27,0	14,418	10,600	0,482
	47	22,2	1,0	31,0	23,649	16,200	0,736
20	47	20,6	1,0	31,0	19,905	15,000	0,682
	52	22,2	1,1	34,0	23,656	18,500	0,841
25	52	20,6	1,0	35,0	21,539	18,100	0,823
	62	25,4	1,1	40,0	32,881	26,600	1,209
30	62	23,8	1,0	41,0	30,998	27,100	1,232
	72	30,2	1,1	47,0	43,688	36,200	1,645
35	72	27,0	1,1	47,0	42,125	37,600	1,709
	80	34,9	1,5	54,0	56,219	47,300	2,150
40	80	30,2	1,1	52,0	48,186	43,800	1,991
	90	36,5	1,5	58,0	59,431	59,600	2,709
45	85	30,2	1,1	56,0	51,994	51,100	2,323
	100	39,7	1,5	64,0	82,479	73,600	3,345
50	90	30,2	1,1	59,0	59,553	58,400	2,655
	110	44,4	2,0	73,0	99,898	96,200	4,373
55	100	33,3	1,5	64,0	74,481	66,800	3,036
	120	49,2	2,0	80,0	110,379	108,000	4,909
60	110	36,5	1,5	71,0	82,491	85,800	3,900
	130	54,0	2,1	86,0	128,709	128,000	5,818
65	120	38,1	1,5	76,0	90,746	94,400	4,291
	140	58,7	2,1	94,0	146,328	147,000	6,600
70	125	39,7	1,5	81,0	87,349	98,100	4,459



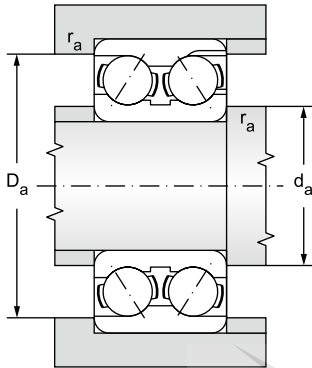

\*\* Bearings in the new standard NEW FORCE

Limiting speed for lubrication with		Bearing designation	Abutment and Fillet Dimensions				Weight kg
Grease	Oil		d	d <sub>a</sub> min	D <sub>a</sub> max	r <sub>a</sub> max	
min <sup>-1</sup>							
16 000	19 000	<b>3200X**</b>	10	14	25	0,6	0,05
16 000	19 000	<b>3200**</b>	10	14	25	0,6	0,05
14 000	17 000	<b>3201**</b>	12	16	27	0,6	0,05
13 000	16 000	<b>3202**</b>	15	19	30	0,6	0,07
10 600	12 600	<b>3302**</b>	15	21	26	1	0,13
11 000	13 000	<b>3203**</b>	17	21	35	0,6	0,1
9 400	11 000	<b>3303**</b>	17	23	41	1	0,19
9 400	11 000	<b>3204**</b>	20	25	42	1	0,17
8 400	10 000	<b>3304**</b>	20	27	45	1	0,23
8 400	10 000	<b>3205**</b>	25	30	46	1	0,19
7 100	8 400	<b>3305**</b>	25	32	55	1	0,37
7 100	8 400	<b>3206**</b>	30	35	56	1	0,31
6 000	7 100	<b>3306**</b>	30	37	65	1	0,58
6 000	7 100	<b>3207**</b>	35	41	65	1	0,48
5 300	6 300	<b>3307**</b>	35	44	71	1,5	0,78
5 300	6 300	<b>3208**</b>	40	46	73	1	0,65
4 700	5 600	<b>3308**</b>	40	49	81	1,5	1,05
5 000	6 000	<b>3209**</b>	45	51	78	1	0,7
4 200	5 000	<b>3309**</b>	45	54	91	1,5	1,41
4 500	5 300	<b>3210**</b>	50	56	83	1	0,74
3 800	4 500	<b>3310**</b>	50	60	100	2	1,9
4 200	5 000	<b>3211**</b>	55	62	91	1,5	1,05
3 300	4 000	<b>3311**</b>	55	65	110	2	2,48
3 800	4 500	<b>3212**</b>	60	67	101	1,5	1,36
3 200	3 800	<b>3312**</b>	60	72	118	2	3,17
3 500	4 200	<b>3213**</b>	65	72	111	1,5	1,76
3 000	3 500	<b>3313**</b>	65	77	128	2	4,01
3 200	3 800	<b>3214**</b>	70	77	116	1,5	1,93



Double row angular contact ball bearings

d = 75 to 110 mm

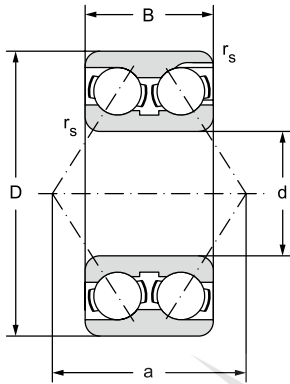

12.2.3

Main dimensions					Basic load rating		Fatigue load limit
d	D	B	r <sub>s</sub>	a	dynamic (C <sub>r</sub> )	static (C <sub>0r</sub> )	P <sub>u</sub>
mm					kN		kN
75	130	41,3	1,5	84,0	96,151	110,000	4,939
80	140	44,4	2,0	82,0	95,000	106,000	3,900
	170	68,3	2,1	101,0	156,000	182,000	6,000
85	150	49,2	2,0	88,0	110,000	124,000	4,400
	180	73,0	3,0	107,0	176,000	195,000	6,550
90	160	52,4	2,0	94,0	120,000	130,000	4,550
	190	73,0	3,0	112,0	180,000	195,000	6,400
95	170	55,6	2,1	101,0	146,000	159,000	5,400
	200	77,8	3,0	118,0	216,000	225,000	7,500
100	180	60,3	2,1	107,0	166,000	178,000	6,000
	215	82,6	3,0	127,0	255,000	255,000	8,650
110	200	69,8	2,1	119,0	212,000	212,000	7,200
	240	92,1	3,0	142,0	305,000	291,000	9,800

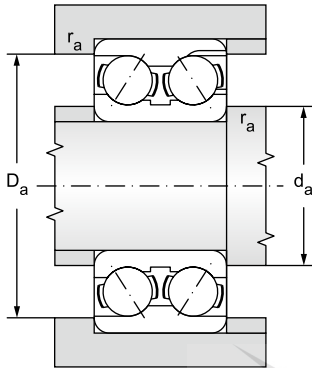

\*\* Bearings in the new standard NEW FORCE

Limiting speed for lubrication with		Bearing designation	Abutment and Fillet Dimensions				Weight kg
Grease	Oil		d	d <sub>a</sub> min	D <sub>a</sub> max	r <sub>a</sub> max	
min <sup>-1</sup>							
3 200	3 800	<b>3215**</b>	75	82	121	1,5	2,08
2 800	3 800	<b>3216</b>	80	91	129	2	2,65
2 400	3 400	<b>3316</b>		92	158	2	6,8
2 600	3 600	<b>3217</b>	85	96	139	2	3,4
2 200	3 200	<b>3317</b>		99	166	2,5	8,3
2 400	3 400	<b>3218</b>	90	101	149	2	4,15
2 000	3 000	<b>3318</b>		104	176	2,5	9,25
2 200	3 200	<b>3219</b>	95	107	158	2	5
1 900	2 800	<b>3319</b>		109	186	2,5	11
2 000	3 000	<b>3220</b>	100	112	168	2	6,1
1 800	2 600	<b>3320</b>		114	201	2,5	13,5
1 900	2 800	<b>3222</b>	110	122	188	2	8,8
1 700	2 400	<b>3322</b>		124	226	2,5	19



Four-point contact bearings d = 15 to 200 mm

d = 15 to 75 mm

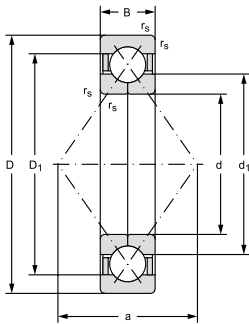

Main dimensions					Basic load rating		Fatigue load limit	Limiting speed for lubrication with		Weight
					dynamic	static		Grease	Oil	
d	D	B	rs min	a	Cr	Cor	Pu			
mm					kN		kN	m <sup>-1</sup>		kg
15	35	11	0,6	18	12,7	8,3	0,36	15000	20000	0,062
17	40	12	0,6	20	15,9	10,6	0,45	14000	19000	0,082
	47	14	1	22	23,4	15	0,64	12000	17000	0,14
20	52	15	1,1	25	29,6	20	0,85	10000	15000	0,18
25	52	15	1	25	25,1	20	0,83	9500	14000	0,16
	62	17	1,1	30	39,1	28	1,18	9000	14000	0,29
30	62	16	1	32	35,1	28,5	1,2	8500	12000	0,24
	72	19	1,1	36	49,4	39	1,63	7500	10000	0,42
35	72	17	1,1	37	46,2	39	1,63	7500	10000	0,36
	80	21	1,5	40	59,2	46,5	1,96	7000	9500	0,57
40	80	18	1,1	42	52,7	45	1,9	6700	9000	0,45
	90	23	1,5	46	71,5	58,5	2,45	6300	8500	0,78
45	85	19	1,1	46	58,5	51	2,16	6300	8500	0,52
	100	25	1,5	51	93,6	76,5	3,25	5600	7500	1,05
50	90	20	1,1	49	61,8	56	2,4	5600	7500	0,59
	110	27	2	56	111	91,5	3,9	5000	6700	1,35
	110	27	2	56	111	91,5	3,9	5000	6700	1,35
55	100	21	1,5	54	79,3	76,5	3,2	5300	7000	0,77
	120	29	2	61	127	108	4,55	4500	6000	1,75
60	110	22	1,5	60	92,3	86,5	3,65	4800	6300	0,99
	130	31	2,1	67	146	125	5,3	4300	5600	2,15
65	120	23	1,5	65	104	104	4,4	4300	5600	1,2
	140	33	2,1	72	165	146	6,1	4000	5300	2,7
70	125	24	1,5	68	114	114	4,8	4300	5600	1,32
	150	35	2,1	77	186	166	6,7	3600	4800	3,15
75	130	25	1,5	72	117	122	5,2	4000	5300	1,45
	160	37	2,1	82	199	186	7,35	3400	4500	3,9

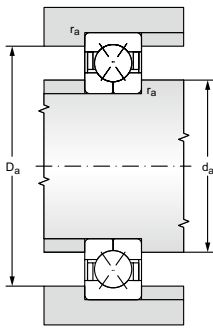

Bearing designation		Dimensions			Dimensions of grooves			Abutment and Fillet Dimensions		
Bearing with safety grooves	Bearing without safety grooves	d	d <sub>i</sub>	D <sub>i</sub>	b	h	r <sub>o</sub>	d <sub>a</sub> min	D <sub>a</sub> max	r <sub>a</sub> max
mm										
<b>QJ202N2MA</b>	-	15	22	28,1	3	2,2	0,5	19,2	30,8	0,6
<b>QJ203N2MA</b>	-	17	23,5	32,5	3,5	2,5	0,5	21,2	35,8	0,6
<b>QJ303N2MA</b>	-	27,7	36,3	45	3,5	3,5	0,5	22,6	41,4	1
<b>QJ304N2MA</b>	<b>QJ304MA</b>	20	27,5	40,8	4,5	3,5	0,5	27	45	1
<b>QJ205N2MA</b>	<b>QJ205MA</b>	25	31,5	43	4,5	3	0,5	30,6	46,4	1
<b>QJ305N2MA</b>	<b>QJ305MA</b>		34	49	4,5	3,5	0,5	32	55	1
<b>QJ206N2MA</b>	<b>QJ206MA</b>	30	37,5	50,8	4,5	3,5	0,5	35,6	56,4	1
<b>QJ306N2MA</b>	<b>QJ306MA</b>		40,5	58,2	4,5	3,5	0,5	37	65	1
<b>QJ207N2MA</b>	-	35	44	59	4,5	3,5	0,5	42	65	1
<b>QJ307N2MA</b>	<b>QJ307MA</b>		46,2	64,3	5,5	4	0,5	44	71	1,5
<b>QJ208N2MA</b>	<b>QJ208MA</b>	40	49,5	66	5,5	4	0,5	47	73	1
<b>QJ308N2MA</b>	<b>QJ308MA</b>		52	72,5	5,5	4	0,5	49	81	1,5
-	<b>QJ209MA</b>	45	54,5	72	-	-	-	52	78	1
<b>QJ309N2MA</b>	<b>QJ309MA</b>		58	81,2	6,5	5	0,5	54	91	1,5
-	<b>QJ210MA</b>	50	59,5	76,5	5,5	4	0,5	57	83	1
-	<b>QJ310MA</b>		65	90	-	-	-	61	99	2
-	<b>QJ310PHAS</b>		65	90	-	-	-	61	99	2
<b>QJ211N2MA</b>	<b>QJ211MA</b>	55	66	84,7	6,5	5	0,5	64	91	1,5
<b>QJ311N2MA</b>	<b>QJ311MA</b>		70,5	97,8	6,5	8,1	0,5	66	109	2
<b>QJ212N2MA</b>	<b>QJ212MA</b>	60	72	93	6,5	5	0,5	69	101	1,5
<b>QJ312N2MA</b>	<b>QJ312MA</b>		77	106	6,5	8,1	0,5	72	118	2
<b>QJ213N2MA</b>	<b>QJ213MA</b>	65	78,5	101	6,5	6,5	0,5	74	111	1,5
-	<b>QJ313MA</b>		82,5	115	-	-	-	77	128	2
<b>QJ214N2MA</b>	<b>QJ214MA</b>	70	83,5	106	6,5	6,5	0,5	79	116	1,5
<b>QJ314N2MA</b>	<b>QJ314MA</b>		89	123	8,5	10,1	2	82	138	2
<b>QJ215N2MA</b>	<b>QJ215MA</b>	75	88,5	112	6,5	6,5	0,5	84	121	1,5
-	-		104	131	8,5	10,1	2	87	148	2



Four-point contact bearings

d = 80 to 200 mm

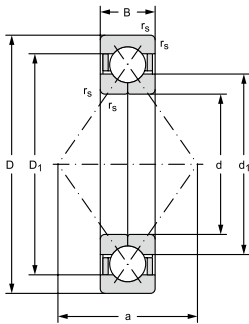

Main dimensions					Basic load rating		Fatigue load limit	Limiting speed for lubrication with		Weight
					dynamic	static		Grease	Oil	
d	D	B	r <sub>s</sub> min	a	C <sub>r</sub>	C <sub>or</sub>	P <sub>u</sub>			
mm					kN		kN	m <sup>-1</sup>		kg
80	140	26	2	77	138	146	5,85	3600	4800	1,85
	170	39	2,1	88	216	208	8	3200	4300	4,6
85	150	28	2	83	148	160	6,2	3400	4500	2,25
	180	41	3	93	234	236	8,65	3000	4000	5,45
90	160	30	2	88	174	186	6,95	3200	4300	2,75
	190	43	3	98	265	285	10,2	2800	3800	6,45
95	170	32	2,1	93	199	212	7,8	3000	4000	3,35
	200	45	3	103	286	315	11	2600	3600	7,45
100	180	34	2,1	98	225	240	8,65	2800	3800	4,05
	215	47	3	110	307	340	11,6	2400	3400	9,3
110	200	38	2,1	109	265	305	10,4	2400	3400	5,6
	240	50	3	123	390	475	15	2000	3000	12,5
120	215	40	2,1	117	286	340	11,2	2200	3200	6,95
	260	55	3	133	390	490	15	1900	2800	16
130	230	40	3	126	296	365	11,6	1900	2800	7,75
	280	58	4	144	423	560	16,6	1800	2600	19,5
140	250	42	3	137	325	440	13,2	1800	2600	9,85
	300	62	4	154	468	640	18,6	1800	2600	24
150	270	45	3	147	338	465	15,3	1700	2400	12,5
	320	65	4	165	494	710	19,6	1600	2200	29
160	290	48	3	158	390	570	17,6	1600	2200	15,5
	340	68	4	175	540	815	21,6	1500	2000	34,5
170	310	52	4	168	397	600	18,3	1600	2200	19,5
	360	72	4	186	618	965	25	1400	1900	41,5
180	320	52	4	175	436	680	19	1500	2000	20,5
	380	75	4	196	637	1020	26	1300	1800	47,5
190	400	78	5	207	690	1100	28,5	1200	1600	49
200	360	58	4	196	507	850	23,2	1300	1800	28,5

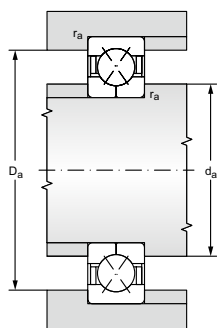

Bearing designation		Dimensions			Dimensions of grooves			Abutment and Fillet Dimensions		
Bearing with safety grooves	Bearing without safety grooves	d	d <sub>1</sub>	D <sub>1</sub>	b	h	r <sub>0</sub>	d <sub>a</sub> min	D <sub>a</sub> max	r <sub>a</sub> max
mm										
<b>QJ216N2MA</b>	QJ216MA	80	95,3	120	6,5	8,1	1	91	129	2
<b>QJ316N2MA</b>	-	-	111	139	8,5	10,1	2	92	158	2
<b>QJ217N2MA</b>	QJ217MA	85	100	128	6,5	8,1	1	96	139	2
<b>QJ317N2MA</b>	-	-	117	148	10,5	11,7	2	99	166	2,5
<b>QJ218N2MA</b>	-	90	114	136	6,5	8,1	1	101	149	2
<b>QJ318N2MA</b>	-	-	124	156	10,5	11,7	2	104	176	2,5
<b>QJ219N2MA</b>	-	95	120	145	6,5	8,1	1	107	158	2
<b>QJ319N2MA</b>	-	-	131	165	10,5	11,7	2	109	186	2,5
<b>QJ220N2MA</b>	-	100	127	153	8,5	10,1	2	112	168	2
<b>QJ320N2MA</b>	-	-	139	176	10,5	11,7	2	114	201	2,5
<b>QJ222N2MA</b>	-	110	141	169	8,5	10,1	2	122	188	2
<b>QJ322N2MA</b>	-	-	154	196	10,5	11,7	2	124	226	2,5
<b>QJ224N2MA</b>	-	120	152	183	10,5	11,7	2	132	203	2
<b>QJ324N2MA</b>	-	-	169	211	10,5	11,7	2	134	246	2,5
<b>QJ226N2MA</b>	-	130	165	195	10,5	11,7	2	144	216	2,5
<b>QJ326N2MA</b>	-	-	182	227	10,5	12,7	2	147	263	3
<b>QJ228N2MA</b>	-	140	179	211	10,5	11,7	2	154	236	2,5
<b>QJ328N2MA</b>	-	-	196	244	10,5	12,7	2	157	283	3
<b>QJ230N2MA</b>	-	150	194	226	10,5	11,7	2	164	256	2,5
<b>QJ330N2MA</b>	-	-	211	259	10,5	12,7	2	167	303	3
<b>QJ232N2MA</b>	-	160	206	243	10,5	12,7	2	174	276	2,5
<b>QJ332N2MA</b>	-	-	224	276	10,5	12,7	2	177	323	3
<b>QJ234N2MA</b>	-	170	221	258	10,5	12,7	2	187	293	3
<b>QJ334N2MA</b>	-	-	237	293	10,5	12,7	2	187	343	3
<b>QJ236N2MA</b>	-	180	231	269	10,5	12,7	2	197	303	3
<b>QJ336N2MA</b>	-	-	252	309	10,5	12,7	2	197	363	3
<b>QJ338N2MA</b>	-	190	263	326	10,5	12,7	2	210	380	4
<b>QJ240N2MA</b>	-	200	258	302	10,5	12,7	2	217	363	3