



**ACCESSORIES**



**English**



**Español**



**Italiano**



**Deutsch**



**Français**



**Nederlands**



**Polskie**

**Ball Studs**

Pernos de bola • Perni sferici • Kugelbolzen  
Rotules • bal hengsten • Szpilki kulkowe

**122**

**Dust Seals**

Guardapolvos • Parapolvere • Staub-Dichtungen  
Joints de poussière • Stof zeehonden • uszczelki przeciwpyłowe

**124**

**Nuts**

Tuercas • Dadi • Muttern  
Noix • Noten • Orzechy

**126**

**Washers**

Arandelas • Rondelle • Unterlegscheiben  
Rondelles • Unterlegscheiben • Podkładki

**128**



**BALL STUDS**

**Description:**

Ball studs are available in three different series that can be interchanged with corresponding ball joints, hardened threaded, burnished threaded and hardened riveting. Specials can be produced to suit customers requirements, so please enquire for any item not shown.

**Material Specifications:**

Ball stud: Steel 212A42 hardened and zinc plated and clear trivalent passivate.

**Features**

Metric & imperial thread sizes  
 Course & fine threads  
 Interchangeable with ball joints  
 Burnished ball for smooth operation

**Possible Applications**

Light to medium industrial/mechanical  
 Construction equipment  
 Agricultural equipment  
 Industrial equipment

**Temperature Range**

-40°C to +170°C

**Specification**

ELV & RoHS compliant

**BALL STUDS: THREADED SERIES HARDENED (METRIC)**

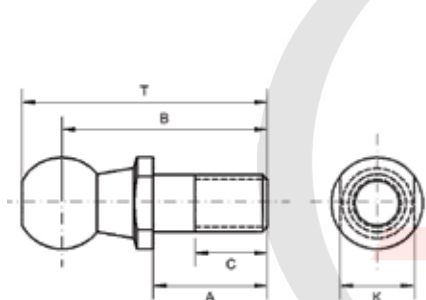

**Stud:** Steel 212A42, Hardened, Zinc Plated and Clear Trivalent Passivate

**Specification:** ELV and RoHS Compliant



Part No. Right Hand	Ball Dia.	Stud Thread	A	B	C	K	T	Ball Type
M2662	8	M5X0.80	10.2	19.2	6.2	7	22.7	TYPE A
M2667	10	M6X1.00	12.5	23.5	8.5	8	28.0	TYPE A
M2671	13	M8X1.25	16.5	29.5	11.2	11	35.0	TYPE A
M2675	16	M10X1.50	20.0	36.0	12.7	13	43.0	TYPE A
M2679	16	M12X1.75	20.0	36.0	17.0	13	43.0	TYPE A
M2683	19	M14X1.50	28.0	48.0	17.2	16	56.5	TYPE A
M2687	19	M14X2.00	28.0	48.0	17.2	16	56.5	TYPE A

For stainless steel add 'SS' to part no. For example 'M2662 SS'

ACCESSORIES



**BALL STUDS: THREADED SERIES HARDENED (IMPERIAL)**

Part No. Right Hand	Ball Dia.	Stud Thread	A	B	C	K	T	Ball Type
M1688	0.251	10 - 32 UNF	0.437	0.874	0.360	0.312	0.965	TYPE A
M1158	0.348	1/4 - 28 UNF	0.562	1.015	0.460	0.375	1.166	TYPE A
M1059	0.251	1/4 - 28 UNF	0.562	0.949	0.480	0.312	1.052	TYPE A
M1247	0.310	1/4 - 28 UNF	0.562	1.011	0.480	0.375	1.141	TYPE B
M2262	0.304	1/4 - 28 UNF	0.562	1.030	0.468	0.375	1.156	TYPE C
M1205	0.406	5/16 - 24 UNF	0.687	1.218	0.600	0.437	1.375	TYPE A
M1240	0.311	5/16 - 24 UNF	0.562	1.046	0.500	0.437	1.172	TYPE A
M1187	0.340	5/16 - 24 UNF	0.687	1.234	0.620	0.437	1.375	TYPE B
M2263	0.343	5/16 - 24 UNF	0.687	1.218	0.593	0.437	1.343	TYPE C
M1171	0.489	3/8 - 24 UNF	0.875	1.516	0.780	0.500	1.719	TYPE A
M1333	0.422	3/8 - 24 UNF	0.875	1.522	0.780	0.500	1.687	TYPE B
M2264	0.416	3/8 - 24 UNF	0.875	1.562	0.781	0.500	1.722	TYPE C
M2265	0.554	1/2 - 20 UNF	1.125	2.000	1.000	0.625	2.230	TYPE C

**BALL STUDS: RIVETING SERIES HARDENED (METRIC)**

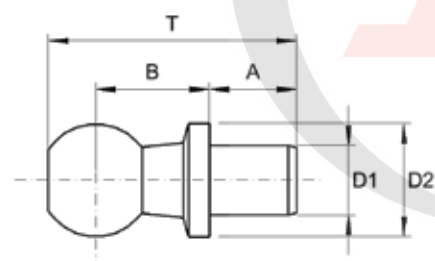

**Stud:** Steel 212A42, Ball Induction Hardened, Zinc Plated and Clear Trivalent Passivate  
**Specification:** ELV and RoHS Compliant



Part No. Right Hand	Ball Dia.	A	B	T	D1	D2	Ball Type
M2691	8	4	9	16.5	5	8	5.000 / 5.075
M2692	8	7.5	9	20.0	5	8	5.000 / 5.075
M2693	10	4.5	11	19.5	6	10	6.000 / 6.075
M2694	10	8	11	23.5	6	10	6.000 / 6.075
M2695	13	5	13	23.5	8	13	8.000 / 8.090
M2696	13	10	13	28.5	8	13	8.000 / 8.090
M2697	16	6	16	29.0	10	16	10.000 / 10.090
M2698	16	13	16	35.0	10	16	10.000 / 10.090
M2699	19	12	20	40.5	14	19	14.000 / 14.110
M2700	19	18	20	46.5	14	19	14.000 / 14.110



ACCESSORIES

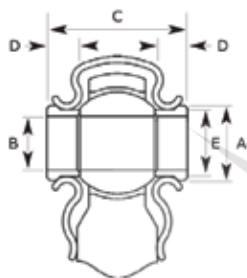

### DUST SEALS & SPACERS: RDS - RDSS

**Description:**

Dust seals and spacers are available to suit standard rod ends and will give extra protection when used in harsh environments. In certain atmospheres condensation may occur and be trapped inside of the seal, therefore increasing the risk of corrosion. It is essential to use a suitable grease able to withstand water, a recommended grease is Shell Alvania No. 2 or equivalent.

**Material Specifications:**

Dust seal: Neoprene.  
Spacer: Steel 230M07PB zinc plated and clear trivalent passivate.

**Features**

To suit both metric & imperial rod end bearings

**Possible Applications**

All rod end bearing applications

**Temperature Range**

-30°C to +120°C

**Specification**

ELV & RoHS compliant



ACCESSORIES



RUBBER DUST SEALS & SPACERS

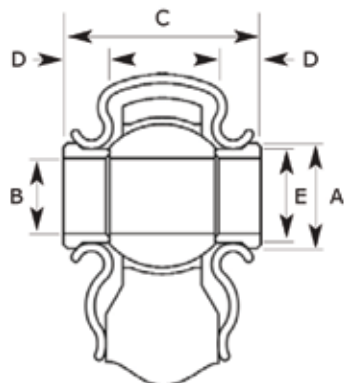

**Dust Seal:** Neoprene Rubber  
**Spacer:** Steel 230M07Pb, Zinc Plated and Clear Trivalent Passivate  
**Specification:** ELV and RoHS Compliant



Part No.	To Suit Rod End Bore Sizes				
RDS-04	6mm	8mm	1/4"	5/16"	
RDS-06	10mm	3/8"	7/16"		
RDS-08	12mm	14mm	1/2"	5/8"	
RDS-12	16mm	18mm	20mm	22mm	3/4"

SPACERS (METRIC)

Part No.	Bore Size	A	B	C	D	E
RDSS-M06	6	10	6	21	6	8.5
RDSS-M08	8	12	8	24	6	10.0
RDSS-M10	10	14	10	26	6	12.5
RDSS-M12	12	18	12	28	6	15.0
RDSS-M14	14	20	14	35	8	16.5
RDSS-M16	16	22	16	37	8	19.0
RDSS-M18	18	24	18	39	8	21.0
RDSS-M20	20	26	20	41	8	24.0
RDSS-M22	22	28	22	44	8	25.5

SPACERS (IMPERIAL)

Part No.	Bore Size	A	B	C	D	E
RDSS-04	1/4	0.437	0.250	0.875	0.250	0.343
RDSS-05	5/16	0.500	0.312	0.937	0.250	0.437
RDSS-06	3/8	0.562	0.375	1.000	0.250	0.500
RDSS-07	7/16	0.625	0.437	1.062	0.250	0.562
RDSS-08	1/2	0.750	0.500	1.250	0.312	0.656
RDSS-10	5/8	0.875	0.625	1.375	0.312	0.781
RDSS-12	3/4	1.000	0.750	1.500	0.312	0.906



ACCESSORIES

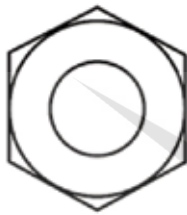

### LOCKING NUTS

**Description:**

Nuts are available in both grade 4 and grade 8, in full and half width sizes. They are used on many of our linkage assemblies to secure rod ends, ball joints and clevis joints into place.

**Material Specifications:**

Nut: Steel grade 4 and grade 8 zinc plated and clear trivalent passivate.

**Features**

Metric & imperial sizes  
Full and half width sizes

**Possible Applications**

All rod end bearing applications  
All linkage assembly applications

**Temperature Range**

-30°C to +120°C

**Specification**

ELV & RoHS compliant

### NUTS: GRADE 4 (METRIC)



**Nut:** Grade 4 Steel, Zinc Plated and Clear Trivalent Passivate

**Specification:** ELV and RoHS Compliant



Part No. Right Hand	Part No. Left Hand	Thread	Type
M7000	M7001	M4 X 0.70	FULL
M7002	M7003	M4 X 0.70	THIN
M7007	M7008	M5 X 0.80	FULL
M7009	M7010	M5 X 0.80	THIN
M7014	M7015	M6 X 1.00	FULL
M7016	M7017	M6 X 1.00	THIN
M7025	M7026	M8 X 1.25	FULL
M7027	M7028	M8 X 1.25	THIN
M7033	M7034	M10 X 1.50	FULL
M7035	M7036	M10 X 1.50	THIN
M7040	M7041	M12 X 1.75	FULL
M7042	M7043	M12 X 1.75	THIN

ACCESSORIES



**NUTS: GRADE 4 (IMPERIAL)**

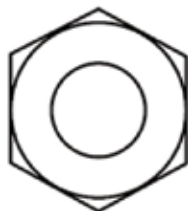

**Nut:** Grade 4 Steel, Zinc Plated and Clear Trivalent Passivate

**Specification:** ELV and RoHS Compliant



Part No. Right Hand	Part No. Left Hand	Thread	Type
M7050	M7051	10-32 UNF	FULL
M7060	M7061	1/4 UNF	FULL
M7062	M7063	1/4 UNF	THIN
M7070	M7071	5/16 UNF	FULL
M7072	M7073	5/16 UNF	THIN
M7080	M7081	3/8 UNF	FULL
M7082	M7083	3/8 UNF	THIN
M7090	M7091	7/16 UNF	FULL
M7092	M7093	7/16 UNF	THIN

**NUTS: GRADE 8 (METRIC)**



**Nut:** Grade 8 Steel, Zinc Plated and Clear Trivalent Passivate

**Specification:** ELV and RoHS Compliant



Part No. Right Hand	Part No. Left Hand	Thread	Type
M7814	M7815	M6 X 1.00	FULL
M7825	M7826	M8 X 1.25	FULL
M7827	M7828	M8 X 1.25	THIN
M7833	M7834	M10 X 1.50	FULL
M7835	M7836	M10 X 1.50	THIN
M7840	M7841	M12 X 1.75	FULL
M7842	M7843	M12 X 1.75	THIN

ACCESSORIES



**WASHERS**

**Description:**

Washers are available in both metric and imperial sizes. They are used on many of our linkage assemblies to help secure rod ends, ball joints and clevis joints into place.

**Material Specifications:**

Steel 230M07PB zinc plated and clear trivalent passivate.

**Features:**

Metric & imperial sizes

**Possible Applications:**

All rod end bearing applications  
All linkage assembly applications

**Temperature Range:**

-30°C to +120°C

**Specification:**

ELV & RoHS compliant

**PLAIN WASHERS: STANDARD (METRIC)**

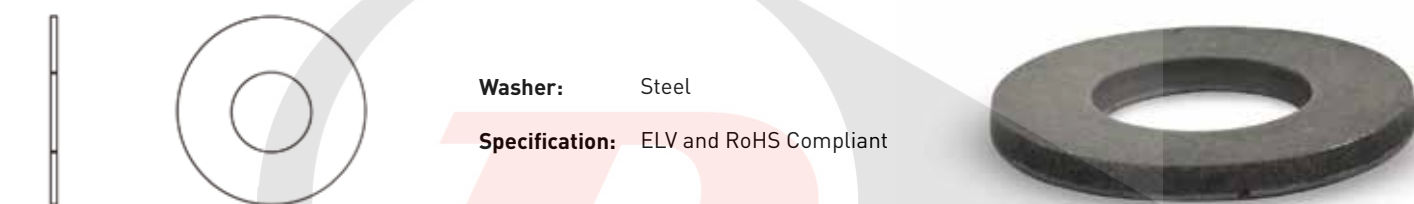

**Washer:** Steel

**Specification:** ELV and RoHS Compliant

Part No. Right Hand	Ball Dia.	Stud Thread	A	B
M7100		10	5.3	1.0
M7111	Special Plain Washer	17	8.4	1.6
M7112	DIN 125 Form B Plain Washer	24	13.0	1.6
M7113	Special Plain Washer	30	17.0	2.0
M7114	Special Plain Washer	21	8.4	1.6
M7117	Special Plain Washer	33	21.0	2.5

**PLAIN WASHERS: STANDARD (METRIC)**

Part No. Right Hand	Ball Dia.	Stud Thread	A	B
M7101	Plain Washer	0.442 / 0.432	0.268 / 0.263	0.032
M7102	Plain Washer	0.510 / 0.490	0.332 / 0.327	0.032
M7116	Plain Washer	0.625 / 0.615	0.332 / 0.327	0.072
M7103	Plain Washer	0.580 / 0.555	0.415 / 0.410	0.032
M7104	Plain Washer	0.753 / 0.743	0.514 / 0.512	0.039
M7105	Plain Washer	1.250 / 1.240	0.656 / 0.651	0.072
M7106	Plain Washer	1.375 / 1.365	0.656 / 0.651	0.072
M7107	Plain Washer	1.625 / 1.615	0.656 / 0.651	0.128
M7108	Plain Washer	2.000 / 1.990	0.656 / 0.651	0.128
M7109	Plain Washer	0.875 / 0.870	0.395 / 0.390	0.072
M7110	Plain Washer	1.500 / 1.480	0.333 / 0.328	0.057



[www.dunlopbt.com](http://www.dunlopbt.com)

“We are proud to be a European manufacturer; it is a privilege to supply our products to some of the world’s most prestigious original equipment manufacturers in the Agricultural, Automotive, Construction, Industrial and Motor Sport sectors”.

“Our distributor network is vital to the continued global growth of the DUNLOP brand and our valued distributor partners form the perfect link between manufacturer and end user”.

“Our commitment to our staff, our customers and the environment is of paramount importance to our company, we will continue to develop our organisational skills to further enhance our company’s potential, to engage in sustainable practices and anticipate the needs and expectations of our customers”.

“We **love** our products”.

Ray Mifsud, *Managing Director.*



**#WeLoveOurProducts**



[www.rodavigo.net](http://www.rodavigo.net)

+34 986 288118  
Servicio de Att. al Cliente



LINKAGES

DUNLOP BTL Ltd, MPT House, Brunswick Road, Cobbs Wood Industrial Estate, Ashford, Kent TN23 1EL, UK  
T: +44 (0)1233 663340 • F: +44 (0)1233 664440 • E: [sales@dunlopctl.com](mailto:sales@dunlopctl.com) • W: [www.dunlopctl.com](http://www.dunlopctl.com)

DUNLOP™ and the Flying D device™ are used under licence

Polígono Industrial O Rebullón s/n. 36416 - Mos - España - [rodavigo@rodavigo.com](mailto:rodavigo@rodavigo.com)