



Accesorios FAG



Accesorios FAG

Manguitos de montaje

Los accesorios FAG tales como manguitos de montaje, manguitos de desmontaje, tuercas ranuradas, chapas de seguridad y grapas de seguridad han de pedirse por separado.

Manguitos de montaje

Con ayuda de los manguitos de montaje se fijan los rodamientos con agujero cónico sobre ejes cilíndricos (ver página 140). Para los ejes se admiten tolerancias de mecanizado más amplias que si el rodamiento estuviera montado directamente sobre el eje (tolerancias del eje, pág. 110 a 114). Los manguitos de montaje se suministran conjuntamente con tuercas y elementos de seguridad.

Las tablas con las dimensiones contienen manguitos de montaje para ejes con dimensiones métricas. Las dimensiones y material de los manguitos de montaje para ejes métricos son según DIN 5415 (edición 02.93) y según ISO 2982-1 (edición 09.95). Los manguitos de montaje se fabrican en acero (resistencia mínima 430 N/mm²)

Bajo demanda se suministran manguitos de montaje en pulgadas.

La tolerancia del agujero de los manguitos de montaje antes de partirlos corresponde a JS9 para una conicidad de 1:12 y JS7 para una conicidad de 1:30.

El montaje y el desmontaje de grandes rodamientos se facilita con ayuda del sistema hidráulico (ver páginas 140 y 143). Para este caso existen manguitos de montaje con ranuras para la alimentación del aceite y conexiones para la bomba (sufijo HG). En la tabla de dimensiones se muestran las roscas para la conexión de la bomba.

Manguitos de montaje con tuercas y elementos de seguridad

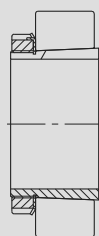

H38, H39, H30 $d_1 \leq 180$ mm
 H31, H33 $d_1 \leq 260$ mm
 H2, H3, H23
 cono 1:12



H38, H39, H30 $d_1 > 180$ mm
 H31, H33 $d_1 > 260$ mm
 H32
 cono 1:12

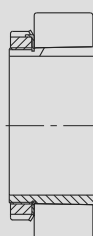

H240 $d_1 \leq 180$ mm
 H241 $d_1 \leq 260$ mm
 cono 1:30
 bajo demanda



H240 $d_1 > 180$ mm
 H241 $d_1 > 260$ mm
 cono 1:30
 bajo demanda

Accesorios FAG

Manguitos de desmontaje

Manguitos de desmontaje

Con los manguitos de desmontaje se fijan rodamientos con agujero cónico en ejes cilíndricos (ver también página 140). El rodamiento se apoya contra un resalte del eje. El manguito cónico se prensa en el agujero del rodamiento hasta el punto en que se consiga la disminución del juego radial requerida.

Las dimensiones y material de los manguitos de desmontaje son según DIN 5416 (edición 03.90) y si tienen la rosca d_2 cambiada (correspondiente al sufijo G) es según ISO 2982-1 (edición 09.95). Los manguitos de desmontaje se fabrican con acero (resistencia mínima 430 N/mm²). La tolerancia del agujero de los manguitos de desmontaje antes de partirlos corresponde a JS9 para una conicidad de 1:12 y JS7 para una conicidad de 1:30.

Las dimensiones de las conexiones para los manguitos de desmontaje FAG con ranuras para la alimentación de aceite y con conexiones para bombas (sufijo H) vienen indicadas en la tabla de las dimensiones. Las dos conexiones para la bomba están distanciadas 90°.

Manguitos de desmontaje



AH38, AH39, AH(X)30,
 AH(X)31, AH2, AH22.
 AH(X)32, AH(X)3
 AH(X)23, AH33
 cono 1:12

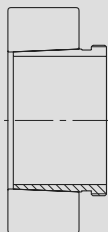

AH240, AH241
 cono 1:30

Accesorios FAG

Tuercas ranuradas · Elementos de seguridad

Tuercas ranuradas

Las tuercas ranuradas sirven para fijar los rodamientos sobre el eje o sobre un manguito de montaje (tuerca y elemento de seguridad se suministra conjuntamente con el manguito). Las tuercas también sirven para montar o desmontar rodamientos en manguitos de desmontaje o gorriones cónicos del eje.

Las tuercas ranuradas tienen cuatro u ocho ranuras repartidas uniformemente en la circunferencia en las cuales se aplican llaves de gancho (ver publ. nº. WL80200 en cuanto a las llaves de gancho FAG).

Las dimensiones y material de las tuercas corresponden a la norma DIN 981 (edición 02.93) y según ISO 2982-2 (edición 09.95), excepto algunas tuercas marcadas en las tablas. Las tuercas se fabrican con acero (resistencia mínima 350 N/mm²).

Las tuercas con diámetros de rosca hasta 200 mm tienen paso métrico y las tuercas mayores rosca trapezoidal.

Chapas de seguridad, grapas de seguridad DIN 506 (02.93)

Para tuercas ranuradas pequeñas se usan chapas de seguridad del tipo MB, MBL. El grosor de las chapas de seguridad desde MB1A hasta MB2A (que no son suministradas con los manguitos de montaje), es según DIN5406, edición 02.93.

Las grapas de seguridad (serie MS), que se adaptan en la hendidura del manguito, se usan para grandes tuercas.

Las chapas y las grapas de seguridad se fabrican con acero (resistencia mínima 300 N/mm²)

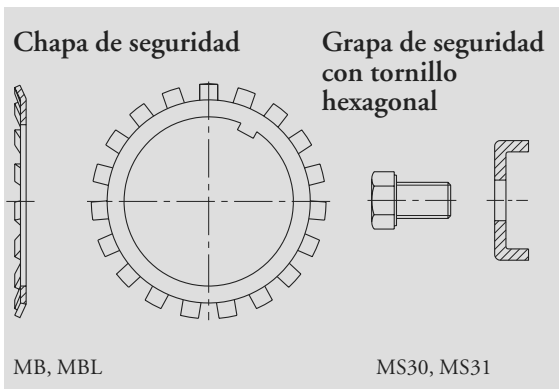

Tuercas ranuradas

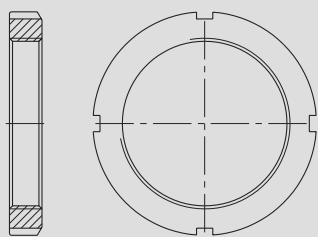

KM, KML, HM

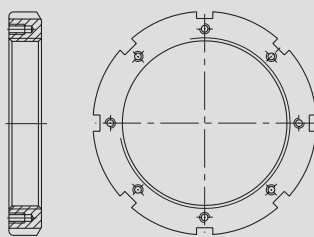

HM30, HM31

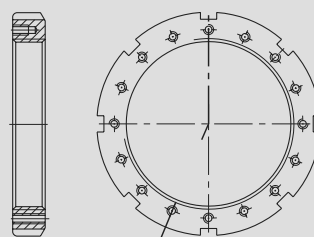

HM30H, HM31H
Agujeros roscados para tornillos de montaje (bajo demanda)

Manguitos de montaje FAG

con tuerca y elemento de seguridad

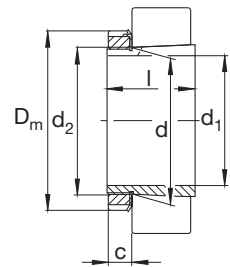

Eje	Dimensiones						Denominación abreviada			Peso ≈ kg
	d	d ₁	D _m	l	c	d ₂	Manguito de montaje completo FAG	Tuerca FAG	Elemento de seguridad FAG	
14	17	14	28	21	6	M17x1	H203	KM3	MB3	0,032
17	20	17	32	24	7	M20x1	H204	KM4	MB4	0,041
	20	17	32	28	7	M20x1	H304	KM4	MB4	0,045
	20	17	32	31	7	M20x1	H2304	KM4	MB4	0,047
20	25	20	38	26	9	M25x1,5	H205	KM5	MB5	0,069
	25	20	38	29	9	M25x1,5	H305	KM5	MB5	0,075
	25	20	38	35	9	M25x1,5	H2305	KM5	MB5	0,087
25	30	25	45	27	9	M30x1,5	H206	KM6	MB6	0,091
	30	25	45	31	9	M30x1,5	H306	KM6	MB6	0,1
	30	25	45	38	9	M30x1,5	H2306	KM6	MB6	0,117
30	35	30	52	29	10	M35x1,5	H207	KM7	MB7	0,129
	35	30	52	35	10	M35x1,5	H307	KM7	MB7	0,147
	35	30	52	43	10	M35x1,5	H2307	KM7	MB7	0,171
35	40	35	58	31	11	M40x1,5	H208	KM8	MB8	0,17
	40	35	58	36	11	M40x1,5	H308	KM8	MB8	0,185
	40	35	58	46	11	M40x1,5	H2308	KM8	MB8	0,222
	40	35	58	50	11	M40x1,5	H3308	KM8	MB8	0,261
40	45	40	65	33	12	M45x1,5	H209	KM9	MB9	0,216
	45	40	65	39	12	M45x1,5	H309	KM9	MB9	0,246
	45	40	65	50	12	M45x1,5	H2309	KM9	MB9	0,283
	45	40	65	54	12	M45x1,5	H3309	KM9	MB9	0,339
45	50	45	70	35	13	M50x1,5	H210	KM10	MB10	0,264
	50	45	70	42	13	M50x1,5	H310	KM10	MB10	0,301
	50	45	70	55	13	M50x1,5	H2310	KM10	MB10	0,353
	50	45	70	60	13	M50x1,5	H3310	KM10	MB10	0,379
50	55	50	75	37	13	M55x2	H211	KM11	MB11	0,292
	55	50	75	45	13	M55x2	H311	KM11	MB11	0,35
	55	50	75	59	13	M55x2	H2311	KM11	MB11	0,426
	55	50	75	65	13	M55x2	H3311	KM11	MB11	0,509
55	60	55	80	38	13	M60x2	H212	KM12	MB12	0,344
	60	55	80	47	13	M60x2	H312	KM12	MB12	0,373
	60	55	80	62	13	M60x2	H2312	KM12	MB12	0,533
	60	55	80	70	13	M60x2	H3312	KM12	MB12	0,591



Manguitos de montaje FAG con tuerca y elemento de seguridad

Eje	Dimensiones						Denominación abreviada			Peso ≈ kg	
	d	d ₁	D _m	l	c ≈	d ₂	Manguito de montaje completo FAG	Tuerca FAG	Elemento de seguridad FAG		
60	65	60	85	40	14	M65x2	H213	KM13	MB13	0,393	
	65	60	85	50	14	M65x2	H313	KM13	MB13	0,452	
	65	60	85	65	14	M65x2	H2313	KM13	MB13	0,553	
	65	60	85	75	14	M65x2	H3313	KM13	MB13	0,629	
	70	60	92	41	14	M70x2	H214	KM14	MB14	0,603	
	70	60	92	52	14	M70x2	H314	KM14	MB14	0,715	
	70	60	92	68	14	M70x2	H2314	KM14	MB14	0,895	
	70	60	92	81	14	M70x2	H3314	KM14	MB14	1,05	
	65	75	65	98	43	15	M75x2	H215	KM15	MB15	0,777
		75	65	98	55	15	M75x2	H315	KM15	MB15	0,826
75		65	98	73	15	M75x2	H2315	KM15	MB15	1,16	
75		65	98	87	15	M75x2	H3315	KM15	MB15	1,36	
70	80	70	105	46	17	M80x2	H216	KM16	MB16	0,876	
	80	70	105	59	17	M80x2	H316	KM16	MB16	1,03	
	80	70	105	78	17	M80x2	H2316	KM16	MB16	1,27	
	80	70	105	89	17	M80x2	H3316	KM16	MB16	1,56	
75	85	75	110	50	18	M85x2	H217	KM17	MB17	1,09	
	85	75	110	63	18	M85x2	H317	KM17	MB17	1,16	
	85	75	110	82	18	M85x2	H2317	KM17	MB17	1,55	
	85	75	110	95	18	M85x2	H3317	KM17	MB17	1,79	
80	90	80	120	52	18	M90x2	H218	KM18	MB18	1,29	
	90	80	120	65	18	M90x2	H318	KM18	MB18	1,39	
	90	80	120	86	18	M90x2	H2318	KM18	MB18	1,69	
	90	80	120	95	18	M90x2	H3318	KM18	MB18	2	
85	95	85	125	55	19	M95x2	H219	KM19	MB19	1,45	
	95	85	125	68	19	M95x2	H319	KM19	MB19	1,51	
	95	85	125	90	19	M95x2	H2319	KM19	MB19	2,06	
	95	85	125	101	19	M95x2	H3319	KM19	MB19	2,27	
90	100	90	130	58	20	M100x2	H220	KM20	MB20	1,63	
	100	90	130	71	20	M100x2	H320	KM20	MB20	1,73	
	100	90	130	76	20	M100x2	H3120	KM20	MB20	1,78	
	100	90	130	97	20	M100x2	H2320	KM20	MB20	2,17	
	100	90	130	106	20	M100x2	H3320	KM20	MB20	2,55	
	95	105	95	140	60	20	M105x2	H221	KM21	MB21	1,82
105		95	140	74	20	M105x2	H321	KM21	MB21	2,08	
105		95	140	101	20	M105x2	H2321	KM21	MB21	2,65	
105		95	140	111	20	M105x2	H3321	KM21	MB21	2,88	

Bajo demanda también son suministrables otras ejecuciones; no duden en contactarnos.

Manguitos de montaje FAG

con tuerca y elemento de seguridad

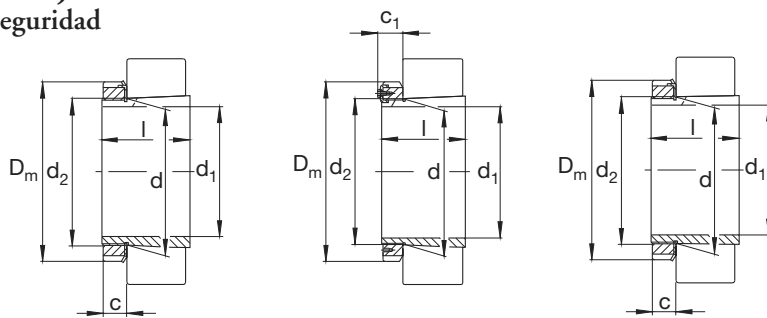

Cono 1:12
Chapa de seguridad MB, MBL

Cono 1:12
Grapa de seguridad MS30

Cono 1:30 (H240)
Chapa de seguridad MBL

Eje	Dimensiones										Denominación abreviada			Peso ≈ kg
	d	d ₁	D _m	l	c	d ₂	R _o	e	t	Manguito de montaje completo FAG	Tuerca FAG	Elemento de seguridad FAG		
	mm													
100	110	100	145	63	21	M110x2					H222	KM22	MB22	2,03
	110	100	145	77	21	M110x2					H322	KM22	MB22	2,16
	110	100	145	81	21	M110x2					H3122	KM22	MB22	2,23
	110	100	145	105	21	M110x2					H2322	KM22	MB22	2,74
	110	100	145	117	21	M110x2					H3322	KM22	MB22	3,23
110	120	110	145	60	22	M120x2					H3924	KML24	MBL24	1,86
	120	110	145	72	22	M120x2					H3024	KML24	MBL24	1,95
	120	110	155	88	22	M120x2					H3124	KM24	MB24	2,61
	120	110	155	112	22	M120x2					H2324	KM24	MB24	3,18
	120	110	155	132	22	M120x2					H3324	KM24	MB24	3,98
115	130	115	155	65	23	M130x2					H3926	KML26	MBL26	2,65
	130	115	155	80	23	M130x2					H3026	KML26	MBL26	2,9
	130	115	165	92	23	M130x2					H3126	KM26	MB26	3,63
	130	115	165	121	23	M130x2					H2326	KM26	MB26	4,9
	130	115	165	139	23	M130x2					H3326	KM26	MB26	5,6
125	140	125	165	66	24	M140x2					H3928	KML28	MBL28	2,94
	140	125	165	82	24	M140x2					H3028	KML28	MBL28	3,25
	140	125	180	97	24	M140x2					H3128	KM28	MB28	4,33
	140	125	180	131	24	M140x2					H2328	KM28	MB28	5,94
	140	125	180	147	24	M140x2					H3328	KM28	MB28	6,63
135	150	135	180	76	26	M150x2					H3930	KML30	MBL30	3,85
	150	135	180	87	26	M150x2					H3030	KML30	MBL30	3,98
	150	135	195	111	26	M150x2					H3130	KM30	MB30	5,49
	150	135	195	139	26	M150x2					H2330	KM30	MB30	6,71
	150	135	195	159	26	M150x2					H3330	KM30	MB30	8,07
140	160	140	190	78	28	M160x3					H3932	KML32	MBL32	4,99
	160	140	190	78	28	M160x3 M6	4,2	7			H3932HG	KML32	MBL32	4,99
	160	140	190	93	28	M160x3					H3032	KML32	MBL32	5,33
	160	140	190	93	28	M160x3 M6	4,2	7			H3032HG	KML32	MBL32	5,32
	160	140	210	119	28	M160x3					H3132	KM32	MB32	7,57
	160	140	210	119	28	M160x3 M6	4,2	7			H3132HG	KM32	MB32	7,55
	160	140	210	147	28	M160x3					H2332	KM32	MB32	9,65
	160	140	210	147	28	M160x3 M6	4,2	7			H2332HG	KM32	MB32	9,65
	160	140	210	170	28	M160x3					H3332	KM32	MB32	11,1
	160	140	210	170	28	M160x3 M6	4,2	7			H3332HG	KM32	MB32	11,1
150	170	150	200	65	29	M170x3					H3834	KML34	MBL34	4,66
	170	150	200	79	29	M170x3					H3934	KML34	MBL34	5,36
	170	150	200	79	29	M170x3 M6	4,2	7			H3934HG	KML34	MBL34	5,36
	170	150	200	101	29	M170x3					H3034	KML34	MBL34	6,08
	170	150	200	101	29	M170x3 M6	4,2	7			H3034HG	KML34	MBL34	6,06
	170	150	220	122	29	M170x3					H3134	KM34	MB34	8,87
	170	150	220	122	29	M170x3 M6	4,2	7			H3134HG	KM34	MB34	8,87
	170	150	200	130	29	M170x3					H24034	KML34	MBL34	7,07
	170	150	200	130	29	M170x3 M6	4,2	7			H24034HG	KML34	MBL34	7,05
	170	150	200	130	29	M170x3 M6	4,2	7			H24034HG	KML34	MBL34	7,05



Manguitos de montaje FAG con tuerca y elemento de seguridad

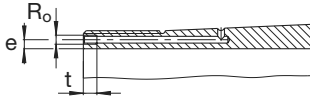

Manguito de montaje hidráulico
(sufijo HG)

Eje	Dimensiones										Denominación abreviada				Peso ≈ kg
	d	d ₁	D _m	l	c	c ₁	d ₂	R _o	e	t	Manguito de montaje completo FAG	Tuerca FAG	Elemento de seguridad FAG	Tornillo hexagonal auto-blocante	
mm															
150	170	150	220	154	29		M170x3				H2334	KM34	MB34	10,2	
	170	150	220	154	29		M170x3	M6	4,2	7	H2334HG	KM34	MB34	10,2	
	170	150	220	175	29		M170x3				H3334	KM34	MB34	12,2	
160	180	160	210	66	30		M180x3				H3836	KML36	MBL36	5,13	
	180	160	210	87	30		M180x3				H3936	KML36	MBL36	6,25	
	180	160	210	87	30		M180x3	M6	4,2	7	H3936HG	KML36	MBL36	6,25	
	180	160	210	109	30		M180x3				H3036	KML36	MBL36	7,01	
	180	160	210	109	30		M180x3	M6	4,2	7	H3036HG	KML36	MBL36	6,99	
	180	160	230	131	30		M180x3				H3136	KM36	MB36	9,46	
	180	160	230	131	30		M180x3	M6	4,2	7	H3136HG	KM36	MB36	9,44	
	180	160	230	161	30		M180x3				H2336	KM36	MB36	12	
	180	160	230	161	30		M180x3	M6	4,2	7	H2336HG	KM36	MB36	12	
	180	160	230	186	30		M180x3				H3336	KM36	MB36	13,8	
170	190	170	220	70	31		M190x3				H3838	KML38	MBL38	5,72	
	190	170	220	89	31		M190x3				H3938	KML38	MBL38	6,8	
	190	170	220	89	31		M190x3	M6	4,2	7	H3938HG	KML38	MBL38	6,8	
	190	170	220	112	31		M190x3				H3038	KML38	MBL38	7,66	
	190	170	220	112	31		M190x3	M6	4,2	7	H3038HG	KML38	MBL38	7,64	
	190	170	220	143	31		M190x3				H24038	KML38	MBL38	8,82	
	190	170	220	143	31		M190x3	M6	4,2	7	H24038HG	KML38	MBL38	8,8	
	190	170	240	141	31		M190x3				H3138	KM38	MB38	10,8	
	190	170	240	141	31		M190x3	M6	4,2	7	H3138HG	KM38	MB38	10,7	
	190	170	240	169	31		M190x3				H2338	KM38	MB38	12,7	
	190	170	240	169	31		M190x3	M6	4,2	7	H2338HG	KM38	MB38	12,7	
	190	170	240	193	31		M190x3				H3338	KM38	MB38	15,4	
180	200	180	240	72	32		M200x3				H3840	KML40	MBL40	6,79	
	200	180	240	98	32		M200x3				H3940	KML40	MBL40	7,82	
	200	180	240	98	32		M200x3	M6	4,2	7	H3940HG	KML40	MBL40	7,8	
	200	180	240	120	32		M200x3				H3040	KML40	MBL40	9,22	
	200	180	240	120	32		M200x3	M6	4,2	7	H3040HG	KML40	MBL40	9,2	
	200	180	240	153	32		M200x3				H24040	KML40	MBL40	10,5	
	200	180	240	153	32		M200x3	M6	4,2	7	H24040HG	KML40	MBL40	10,5	
	200	180	250	150	32		M200x3				H3140	KM40	MB40	12,1	
	200	180	250	150	32		M200x3	M6	4,2	7	H3140HG	KM40	MB40	12,1	
	200	180	250	176	32		M200x3				H2340	KM40	MB40	14	
	200	180	250	176	32		M200x3	M6	4,2	7	H2340HG	KM40	MB40	14	
	200	180	250	204	32		M200x3				H3340	KM40	MB40	17,3	
	200	220	200	260	96	40		Tr220x4	M6	4,2	7	H3944HG	HM3044	MS3044	M6x10
220		200	260	126	40		Tr220x4	M6	4,2	7	H3044XHG	HM3044	MS3044	M6x10	10,3
220		200	280	161	35		Tr220x4	M6	4,2	7	H3144XHG	HM44T	MB44		15,4
220		200	280	186	35		Tr220x4	M6	4,2	7	H2344XHG	HM44T	MB44		17,5
220	240	220	290	101	45		Tr240x4	M6	4,2	7	H3948HG	HM3048	MS3048	M8x16	11,7
	240	220	290	133	45		Tr240x4	M6	4,2	7	H3048HG	HM3048	MS3048	M8x16	13,3

Bajo demanda también son suministrables otras ejecuciones; no duden en contactarnos.

Manguitos de montaje FAG

con tuerca y elemento de seguridad

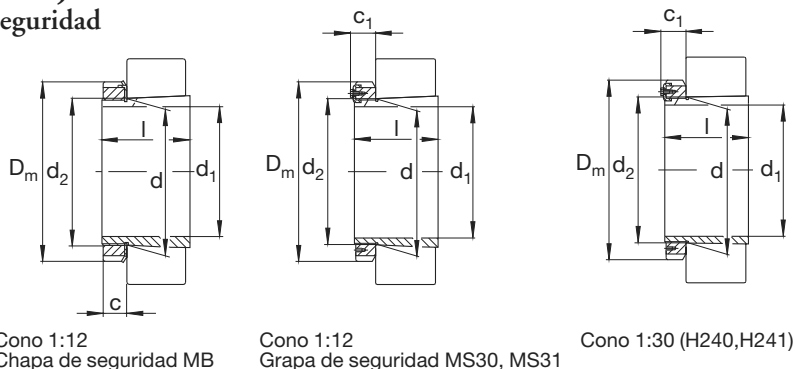
 Cono 1:12
 Chapa de seguridad MB

 Cono 1:12
 Grapa de seguridad MS30, MS31

Cono 1:30 (H240, H241)

Eje	Dimensiones										Denominación abreviada				Peso ≈ kg
	d	d ₁	D _m	l	c ≈	c ₁ ≈	d ₂	R ₀	e	t	Manguito de montaje completo FAG	Tuerca FAG	Elemento de seguridad FAG	Tornillo hexagonal auto-bloqueante	
220	240	220	290	167		45	Tr240x4	M6	4,2	7	H24048HG	HM3048	MS3048	M8x16	14,8
	240	220	300	172	37		Tr240x4	M6	4,2	7	H3148XHG	HM48T	MB48		18
	240	220	300	199	37		Tr240x4	M6	4,2	7	H2348XHG	HM48T	MB48		20,5
240	260	240	310	116		45	Tr260x4	M6	4,2	7	H3952HG	HM3052	MS3048	M8x16	14
	260	240	310	145		45	Tr260x4	M6	4,2	7	H3052XHG	HM3052	MS3048	M8x16	15,5
	260	240	330	190	39		Tr260x4	M6	4,2	7	H3152XHG	HM52T	MB52		22,9
	260	240	330	211	39		Tr260x4	M6	4,2	7	H2352XHG	HM52T	MB52		25,1
260	280	260	330	121		49	Tr280x4	M6	4,2	7	H3956HG	HM3056	MS3056	M8x16	15
	280	260	330	152		49	Tr280x4	M6	4,2	7	H3056HG	HM3056	MS3056	M8x16	17,9
	280	260	330	195		49	Tr280x4	M6	4,2	7	H24056HG	HM3056	MS3056	M8x16	20,2
	280	260	350	195	41		Tr280x4	M6	4,2	7	H3156XHG	HM56T	MB56		25,4
	280	260	350	224	41		Tr280x4	M6	4,2	7	H2356XHG	HM56T	MB56		28,7
280	300	280	360	140		53	Tr300x4	M6	4,2	7	H3960HG	HM3060	MS3060	M8x16	20,2
	300	280	360	168		53	Tr300x4	M6	4,2	7	H3060HG	HM3060	MS3060	M8x16	23,2
	300	280	380	208		53	Tr300x4	M6	4,2	7	H3160HG	HM3160	MS3160	M10x20	29,9
	300	280	380	240		53	Tr300x4	M6	4,2	7	H3260HG	HM3160	MS3160	M10x20	34
300	320	300	380	140		56	Tr320x5	M6	3,5	7	H3964HG	HM3064	MS3064	M8x16	21,5
	320	300	380	171		56	Tr320x5	M6	3,5	7	H3064HG	HM3064	MS3064	M8x16	25
	320	300	400	226		56	Tr320x5	M6	3,5	7	H3164HG	HM3164	MS3164	M10x20	34,7
	320	300	400	258		56	Tr320x5	M6	3,5	7	H3264HG	HM3164	MS3164	M10x20	39,3
320	340	320	400	144		57	Tr340x5	M6	3,5	7	H3968HG	HM3068	MS3064	M8x16	23,9
	340	320	400	187		57	Tr340x5	M6	3,5	7	H3068HG	HM3068	MS3064	M8x16	29,2
	340	320	400	244		57	Tr340x5	M6	3,5	7	H24068HG	HM3068	MS3064	M8x16	32,9
	340	320	440	254		70	Tr340x5	M6	3,5	7	H3168HG	HM3168	MS3168	M12x22	49,5
	340	320	440	288		70	Tr340x5	M6	3,5	7	H3268HG	HM3168	MS3168	M12x22	44,6
340	360	340	420	144		57	Tr360x5	M6	3,5	7	H3972HG	HM3072	MS3072	M8x16	27,1
	360	340	420	188		57	Tr360x5	M6	3,5	7	H3072HG	HM3072	MS3072	M8x16	30,8
	360	340	460	259		73	Tr360x5	M6	3,5	7	H3172HG	HM3172	MS3168	M12x22	54,3
	360	340	460	299		73	Tr360x5	M6	3,5	7	H3272HG	HM3172	MS3168	M12x22	61
360	380	360	450	164		62	Tr380x5	M6	3,5	7	H3976HG	HM3076	MS3076	M10x20	32,3
	380	360	450	193		62	Tr380x5	M6	3,5	7	H3076HG	HM3076	MS3076	M10x20	36,4
	380	360	490	264		75	Tr380x5	M6	3,5	7	H3176HG	HM3176	MS3176	M12x22	60,9
	380	360	490	310		75	Tr380x5	M6	3,5	7	H3276HG	HM3176	MS3176	M12x22	69,2
380	400	380	470	168		66	Tr400x5	M6	3,5	7	H3980HG	HM3080	MS3076	M10x20	38,5
	400	380	470	210		66	Tr400x5	M6	3,5	7	H3080HG	HM3080	MS3076	M10x20	42,2
	400	380	520	272		81	Tr400x5	M6	3,5	7	H3180HG	HM3180	MS3180	M16x25	69,5
	400	380	520	328		81	Tr400x5	M6	3,5	7	H3280HG	HM3180	MS3180	M16x25	80,4



Manguitos de montaje FAG con tuerca y elemento de seguridad

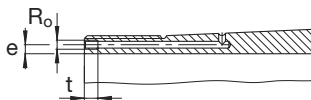

Manguito de montaje hidráulico
(sufijo HG)

Eje	Dimensiones									Denominación abreviada				Peso ≈ kg
	d	d ₁	D _m	l	c ≈	c ₁ ≈	d ₂	R _o	e	t	Manguito de montaje completo FAG	Tuerca FAG	Elemento de seguridad FAG	
mm														
400	420	400	490	168	66	Tr420x5	M6	3,5	7	H3984HG	HM3084	MS3084	M10x20	37,4
	420	400	490	212	66	Tr420x5	M6	3,5	7	H3084XHG	HM3084	MS3084	M10x20	44,5
	420	400	490	274	66	Tr420x5	M6	3,5	7	H24084HG	HM3084	MS3084	M10x20	49,1
	420	400	540	304	89	Tr420x5	M6	3,5	7	H3184HG	HM3184	MS3180	M16x25	84,4
	420	400	540	352	89	Tr420x5	M6	3,5	7	H3284HG	HM3184	MS3180	M16x25	101
410	440	410	520	189	75	Tr440x5	M8	6,5	12	H3988HG	HM3088	MS3088	M12x22	61,9
	440	410	520	228	75	Tr440x5	M8	6,5	12	H3088HG	HM3088	MS3088	M12x22	66,9
	440	410	560	307	89	Tr440x5	M8	6,5	12	H3188HG	HM3188	MS3188	M16x25	103
	440	410	560	361	89	Tr440x5	M8	6,5	12	H3288HG	HM3188	MS3188	M16x25	125
430	460	430	540	189	75	Tr460x5	M8	6,5	12	H3992HG	HM3092	MS3088	M12x22	64,7
	460	430	540	234	75	Tr460x5	M8	6,5	12	H3092HG	HM3092	MS3088	M12x22	76
	460	430	580	326	94	Tr460x5	M8	6,5	12	H3192HG	HM3192	MS3188	M16x25	127
	460	430	580	382	94	Tr460x5	M8	6,5	12	H3292HG	HM3192	MS3188	M16x25	137
450	480	450	560	200	75	Tr480x5	M8	6,5	12	H3996HG	HM3096	MS3096	M12x22	70,2
	480	450	560	237	75	Tr480x5	M8	6,5	12	H3096HG	HM3096	MS3096	M12x22	75,1
	480	450	620	335	94	Tr480x5	M8	6,5	12	H3196HG	HM3196	MS3196	M16x25	134
	480	450	620	397	94	Tr480x5	M8	6,5	12	H3296HG	HM3196	MS3196	M16x25	154
470	500	470	580	208	83	Tr500x5	M8	6,5	12	H39/500HG	HM30/500	MS3096	M12x22	73,5
	500	470	580	247	83	Tr500x5	M8	6,5	12	H30/500HG	HM30/500	MS3096	M12x22	84,3
	500	470	580	309	83	Tr500x5	M8	6,5	12	H240/500HG	HM30/500	MS3096	M12x22	92,6
	500	470	630	356	99	Tr500x5	M8	6,5	12	H31/500HG	HM31/500	MS31/500	M16x25	143
	500	470	630	428	99	Tr500x5	M8	6,5	12	H32/500HG	HM31/500	MS31/500	M16x25	168
500	530	500	630	216	89	Tr530x6	M8	6	12	H39/530HG	HM30/530	MS30/530	M16x25	89,1
	530	500	630	265	89	Tr530x6	M8	6	12	H30/530HG	HM30/530	MS30/530	M16x25	110
	530	500	630	343	89	Tr530x6	M8	6	12	H240/530HG	HM30/530	MS30/530	M16x25	115
	530	500	670	364	102	Tr530x6	M8	6	12	H31/530HG	HM31/530	MS31/530	M20x40	160
530	560	530	650	227	96	Tr560x6	M8	6	12	H39/560HG	HM30/560	MS30/560	M16x25	95,6
	560	530	650	282	96	Tr560x6	M8	6	12	H30/560HG	HM30/560	MS30/560	M16x25	112
	560	530	650	358	96	Tr560x6	M8	6	12	H240/560HG	HM30/560	MS30/560	M16x25	124
	560	530	710	377	107	Tr560x6	M8	6	12	H31/560HG	HM31/560	MS31/560	M20x40	183
	560	530	710	462	107	Tr560x6	M8	6	12	H32/560HG	HM31/560	MS31/560	M20x40	217
	560	530	710	468	107	Tr560x6	M8	6	12	H241/560HG	HM31/560	MS31/560	M20x40	193
560	600	560	700	239	96	Tr600x6	G1/8	8	12	H39/600HG	HM30/600	MS30/530	M16x25	137
	600	560	700	289	96	Tr600x6	G1/8	8	12	H30/600HG	HM30/600	MS30/530	M16x25	149
	600	560	700	377	96	Tr600x6	G1/8	8	12	H240/600HG	HM30/600	MS30/530	M16x25	171
	600	560	750	399	107	Tr600x6	G1/8	8	12	H31/600HG	HM31/600	MS31/560	M20x40	233
	600	560	750	490	107	Tr600x6	G1/8	8	12	H241/600HG	HM31/600	MS31/560	M20x40	247

Bajo demanda también son suministrables otras ejecuciones; no duden en contactarnos.

Manguitos de montaje FAG

con tuerca y elemento de seguridad

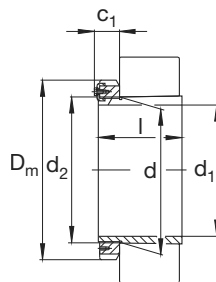
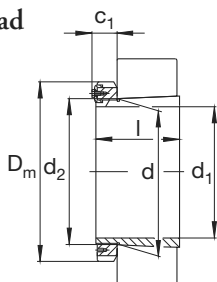
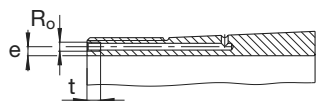

Manguito de montaje hidráulico
(sufijo HG)

Cono 1:12

H240, H241
Cono 1:30

Eje	Dimensiones										Denominación abreviada				Peso ≈
	d	d ₁	D _m	l	c	c ₁	d ₂	R _o	e	t	Manguito de montaje completo FAG	Tuerca FAG	Elemento de seguridad FAG	Tornillo hexagonal auto-blocante kg	
	mm														
600	630	600	730	254	96	Tr630x6	M8	6	12	H39/630HG	HM30/630	MS30/630	M16x25	123	
	630	600	730	301	96	Tr630x6	M8	6	12	H30/630HG	HM30/630	MS30/630	M16x25	140	
	630	600	730	395	96	Tr630x6	M8	6	12	H240/630HG	HM30/630	MS30/630	M16x25	157	
	630	600	800	424	117	Tr630x6	M8	6	12	H31/630HG	HM31/630	MS31/630	M20x40	265	
	630	600	800	521	117	Tr630x6	M8	6	12	H32/630HG	HM31/630	MS31/630	M20x40	296	
	630	600	800	525	117	Tr630x6	M8	6	12	H241/630HG	HM31/630	MS31/630	M20x40	261	
630	670	630	780	264	101	Tr670x6	G1/8	8	12	H39/670HG	HM30/670	MS30/670	M16x25	166	
	670	630	780	324	101	Tr670x6	G1/8	8	12	H30/670HG	HM30/670	MS30/670	M16x25	194	
	670	630	780	418	101	Tr670x6	G1/8	8	12	H240/670HG	HM30/670	MS30/670	M16x25	218	
	670	630	850	456	128	Tr670x6	G1/8	8	12	H31/670HG	HM31/670	MS31/670	M20x40	343	
	670	630	850	548	128	Tr670x6	G1/8	8	12	H241/670HG	HM31/670	MS31/670	M20x40	352	
670	710	670	830	286	111	Tr710x7	G1/8	8	12	H39/710HG	HM30/710	MS30/710	M16x25	201	
	710	670	830	342	111	Tr710x7	G1/8	8	12	H30/710HG	HM30/710	MS30/710	M16x25	229	
	710	670	900	467	131	Tr710x7	G1/8	8	12	H31/710HG	HM31/710	MS31/710	M24x45	395	
710	750	710	870	291	111	Tr750x7	G1/8	8	12	H39/750HG	HM30/750	MS30/750	M16x25	227	
	750	710	950	493	137	Tr750x7	G1/8	8	12	H31/750HG	HM31/750	MS31/750	M24x45	433	
750	800	750	920	303	111	Tr800x7	G1/8	10	12	H39/800HG	HM30/800	MS30/750	M16x25	263	
	800	750	920	366	111	Tr800x7	G1/8	10	12	H30/800HG	HM30/800	MS30/750	M16x25	306	
800	850	800	980	308	112	Tr850x7	G1/8	10	12	H39/850HG	HM30/850	MS30/850	M20x40	300	
850	900	850	1030	326	122	Tr900x7	G1/8	10	12	H39/900HG	HM30/900	MS30/850	M20x40	326	
	900	850	1030	400	112	Tr900x7	G1/8	10	12	H30/900HG	HM30/900	MS30/850	M20x40	426	
900	950	900	1080	344	122	Tr950x8	G1/8	10	12	H39/950HG	HM30/950	MS30/950	M20x40	380	
950	1000	950	1140	358	122	Tr1000x8	G1/8	10	12	H39/1000HG	HM30/1000	MS30/1000	M20x40	428	
1000	1060	1000	1200	372	122	Tr1060x8	G1/8	10	12	H39/1060HG	HM30/1060	MS30/1000	M20x40	488	



Manguitos de desmontaje FAG

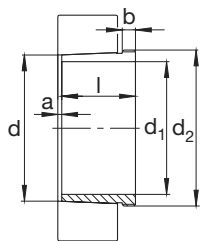

Cono 1:12

Eje	Dimensiones						Denominación abreviada	Peso ≈ kg
	d	d ₁	l	a ≈	b	d ₂		
	mm						Manguito de desmontaje FAG	
35	40	35	25	2	6	M45x1,5	AH208	0,081
	40	35	29	3	6	M45x1,5	AH308	0,09
	40	35	40	3	7	M45x1,5	AH2308	0,13
	40	35	44	3	7	M45x1,5	AH3308	0,147
40	45	40	26	3	6	M50x1,5	AH209	0,095
	45	40	31	3	6	M50x1,5	AH309	0,11
	45	40	44	3	7	M50x1,5	AH2309	0,134
	45	40	47	3	7	M50x1,5	AH3309	0,18
45	50	45	28	3	7	M55x2	AH210	0,114
	50	45	35	3	7	M55x2	AHX310	0,139
	50	45	50	3	9	M55x2	AHX2310	0,213
	50	45	54	3	9	M55x2	AH3310	0,24
50	55	50	29	3	7	M60x2	AH211	0,132
	55	50	37	3	7	M60x2	AHX311	0,164
	55	50	54	3	10	M60x2	AHX2311	0,258
	55	50	60	3	10	M60x2	AH3311	0,301
55	60	55	32	3	8	M65x2	AH212	0,161
	60	55	40	3	8	M65x2	AHX312	0,189
	60	55	58	3	11	M65x2	AHX2312	0,305
	60	55	65	3	11	M70x2	AH3312	0,408
60	65	60	33	4	8	M75x2	AH213	0,213
	65	60	33	4	8	M70x2	AH213G	0,168
	65	60	42	3	8	M75x2	AH313	0,264
	65	60	42	3	8	M70x2	AH313G	0,224
	65	60	61	3	12	M75x2	AH2313	0,4
	65	60	61	3	12	M70x2	AH2313G	0,352
	65	60	71	3	12	M75x2	AH3313	0,492
	65	60	71	3	12	M75x2	AH3313	0,492
65	70	65	34	4	8	M80x2	AH214	0,24
	70	65	34	4	8	M75x2	AH214G	0,187
	70	65	43	4	8	M80x2	AH314	0,28
	70	65	43	4	8	M75x2	AH314G	0,25
	70	65	64	4	12	M80x2	AHX2314	0,459
	70	65	64	4	12	M75x2	AHX2314G	0,407
	70	65	76	4	12	M80x2	AH3314	0,572
	70	65	76	4	12	M80x2	AH3314	0,572
70	75	70	35	4	8	M85x2	AH215	0,259
	75	70	35	4	8	M80x2	AH215G	0,207
	75	70	45	4	8	M85x2	AH315	0,32
	75	70	45	4	8	M80x2	AH315G	0,284
	75	70	68	4	12	M85x2	AHX2315	0,534
	75	70	68	4	12	M80x2	AHX2315G	0,473
	75	70	81	4	12	M85x2	AH3315	0,668
	75	70	81	4	12	M85x2	AH3315	0,668

Bajo demanda también son suministrables otras ejecuciones; no duden en contactarnos.
Ver página 581 hasta 585 para saber la tuerca correspondiente

Manguitos de desmontaje FAG

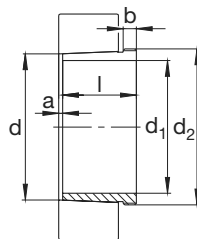

Cono 1:12

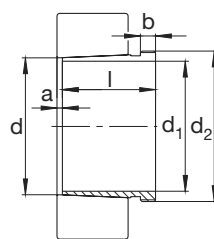
 AH240, AH241
 Cono 1:30

Eje	Dimensiones						Denominación abreviada	Peso ≈ kg
	d	d ₁	l	a ≈	b	d ₂		
	mm						Manguito de desmontaje FAG	
75	80	75	36	4	8	M90x2	AH216	0,284
	80	75	48	4	8	M90x2	AH316	0,366
	80	75	71	4	12	M90x2	AHX2316	0,594
	80	75	81	4	12	M90x2	AH3316	0,712
80	85	80	39	4	9	M95x2	AH217	0,314
	85	80	52	4	9	M95x2	AHX317	0,429
	85	80	60	4	10	M95x2	AH3217	0,517
	85	80	74	4	13	M95x2	AHX2317	0,672
	85	80	86	4	13	M95x2	AH3317	0,81
85	90	85	40	4	9	M100x2	AH218	0,351
	90	85	53	4	9	M100x2	AHX318	0,466
	90	85	63	4	10	M100x2	AHX3218	0,576
	90	85	79	4	14	M100x2	AHX2318	0,774
	90	85	87	4	14	M100x2	AH3318	0,88
90	95	90	43	4	10	M105x2	AH219	0,403
	95	90	57	4	10	M105x2	AHX319	0,532
	95	90	85	4	16	M105x2	AHX2319	0,894
	95	90	94	4	16	M105x2	AH3319	1,03
95	100	95	45	4	10	M110x2	AH220	0,481
	100	95	59	4	10	M110x2	AHX320	0,603
	100	95	62	9	12	M105x2	AH24020	0,5
	100	95	64	4	11	M110x2	AHX3120	0,65
	100	95	78	9	13	M105x2	AH24120	0,641
	100	95	73	4	11	M110x2	AHX3220	0,765
	100	95	90	4	16	M110x2	AHX2320	1,01
	100	95	99	4	16	M110x2	AH3320	1,16
105	110	105	50	4	11	M120x2	AH222	0,547
	110	105	63	4	12	M120x2	AHX322	0,663
	110	105	73	9	13	M115x2	AH24022	0,64
	110	105	68	4	11	M120x2	AHX3122	0,76
	110	105	82	9	13	M115x2	AH24122	0,73
	110	105	98	4	16	M125x2	AHX2322	1,35
	110	105	98	4	16	M120x2	AHX2322G	1,24
	110	105	108	4	16	M125x2	AH3322	1,54
	115	120	115	53	4	12	M130x2	AH224
120		115	60	4	13	M130x2	AHX3024	0,75
120		115	73	9	13	M125x2	AH24024	0,65
120		115	75	4	12	M130x2	AHX3124	0,957
120		115	93	9	13	M130x2	AH24124	1
120		115	105	4	17	M135x2	AHX2324	1,61
120		115	105	4	17	M130x2	AHX2324G	1,48
120		115	123	4	17	M135x2	AH3324	1,98



Manguitos de desmontaje FAG

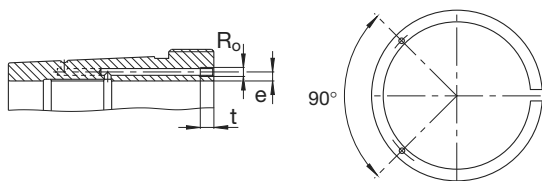

Manguito de desmontaje hidráulico
(sufijo H)

Eje	Dimensiones									Denominación abreviada	Peso ≈ kg
	d	d ₁	l	a ≈	b	d ₂	R _o	e	t		
	mm									Manguito de desmontaje FAG	
125	130	125	53	4	12	M140x2				AH226	0,725
	130	125	67	4	14	M140x2				AHX3026	0,93
	130	125	83	10	14	M135x2				AH24026	0,84
	130	125	78	4	12	M140x2				AHX3126	1,08
	130	125	94	10	14	M140x2				AH24126	1,12
	130	125	98	4	15	M145x2				AHX3226	1,59
	130	125	98	4	15	M140x2				AHX3226G	1,47
	130	125	115	4	19	M145x2				AH2326	1,98
	130	125	115	4	19	M140x2				AHX2326G	1,83
	130	125	131	4	19	M145x2				AH3326	2,34
135	140	135	56	5	13	M150x2				AH228	0,818
	140	135	68	5	14	M150x2				AHX3028	1,01
	140	135	83	10	14	M145x2				AH24028	0,944
	140	135	83	5	14	M150x2				AHX3128	1,28
	140	135	99	10	14	M150x2				AH24128	1,28
	140	135	104	5	15	M155x3				AHX3228	1,83
	140	135	104	5	15	M150x2				AHX3228G	1,72
	140	135	125	5	20	M155x3				AHX2328	2,36
	140	135	125	5	20	M150x2				AHX2328G	2,21
	140	135	138	5	20	M155x3				AH3328	2,7
145	150	145	60	5	14	M160x3				AH230	0,963
	150	145	83	5	15	M160x3				AHX330G	1,36
	150	145	72	5	15	M160x3				AHX3030	1,15
	150	145	90	11	15	M155x3				AH24030	1,11
	150	145	96	5	15	M165x3				AHX3130	1,78
	150	145	96	5	15	M160x3				AHX3130G	1,64
	150	145	115	11	15	M160x3				AH24130	1,62
	150	145	114	5	17	M165x3				AHX3230	2,23
	150	145	114	5	17	M160x3				AHX3230G	2,07
	150	145	135	5	24	M165x3				AHX2330	2,83
	150	145	135	5	24	M160x3				AHX2330G	2,6
	150	145	152	5	24	M165x3				AH3330	3,34
150	160	150	64	5	15	M170x3				AH232	1,7
	160	150	88	5	16	M180x3				AH332	2,69
	160	150	88	5	16	M170x3				AH332G	2,37
	160	150	77	5	16	M170x3				AH3032	2,06
	160	150	77	5	16	M170x3	M6	4,2	7	AH3032H	2
	160	150	95	11	15	M170x3				AH24032	2,27
	160	150	95	11	15	M170x3	M6	8	7	AH24032H	2,27
	160	150	103	5	16	M170x3				AH3132A	2,87
	160	150	103	5	16	M170x3	M6	4,5	7	AH3132AH	2,81
	160	150	124	11	15	M170x3				AH24132	3
	160	150	124	6	20	M180x3				AH3232	4,03
	160	150	124	6	20	M180x3	M6	4,5	7	AH3232H	3,97
	160	150	124	6	20	M170x3				AH3232G	3,63
	160	150	140	6	24	M180x3				AH2332	4,72
	160	150	140	6	24	M180x3	M6	4,5	7	AH2332H	4,66
	160	150	140	6	24	M170x3				AH2332G	4,24

Bajo demanda también son suministrables otras ejecuciones; no duden en contactarnos.
Ver página 581 hasta 585 para saber la tuerca correspondiente

Manguitos de desmontaje FAG

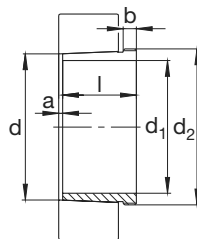

Cono 1:12

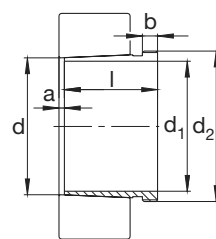
 AH240, AH241
 Conol 1:30

Eje	Dimensiones										Denominación abreviada	Peso ≈ kg
	d	d ₁	l	a ≈	b	d ₂	R _o	e	t	Manguito de desmontaje FAG		
150	160	150	140	6	24	M170x3					AH2332GH	4,17
	160	150	160	6	24	M180x3					AH3332	5,51
160	170	160	48	5	13	M180x3					AH3834	1,36
	170	160	69	5	16	M180x3					AH234	1,98
	170	160	93	5	17	M190x3					AH334	3,07
	170	160	93	5	17	M180x3					AH334G	2,7
	170	160	85	5	17	M180x3					AH3034	2,43
	170	160	85	5	17	M180x3	M6	4,2	7		AH3034H	2,39
	170	160	106	11	16	M180x3					AH24034	2,8
	170	160	104	5	16	M190x3					AH3134	3,4
	170	160	104	5	16	M190x3	M6	4,5	7		AH3134H	5,29
	170	160	125	11	16	M180x3					AH24134	3,21
	170	160	134	6	24	M190x3					AH3234	4,77
	170	160	134	6	24	M190x3	M6	4,5	7		AH3234H	4,7
	170	160	134	6	24	M180x3					AH3234G	4,25
	170	160	146	6	24	M190x3					AH2334	5,27
	170	160	146	6	24	M190x3	M6	4,5	7		AH2334H	5,21
	170	160	146	6	24	M180x3					AH2334G	4,76
	170	160	146	6	24	M180x3	M6	4,5	7		AH2334GH	4,69
	170	160	164	6	24	M190x3					AH3334	6,05
170	180	170	48	5	13	M190x3					AH3836	1,44
	180	170	66	5	13	M190x3					AH3936	1,91
	180	170	69	5	16	M190x3					AH236	2,14
	180	170	92	6	17	M190x3					AH3036	2,84
	180	170	92	6	17	M190x3	M6	4,2	7		AH3036H	2,77
	180	170	116	11	16	M190x3					AH24036	3,18
	180	170	105	5	17	M200x3					AH2236	3,7
	180	170	105	5	17	M200x3	M6	4,5	7		AH2236H	3,62
	180	170	105	5	17	M190x3					AH2236G	3,32
	180	170	116	6	19	M200x3					AH3136A	4,22
	180	170	116	6	19	M190x3	M6	4,5	7		AH3136AH	3,7
	180	170	134	11	16	M190x3					AH24136	3,72
	180	170	140	6	25	M200x3					AH3236	5,33
	180	170	140	6	25	M200x3	M6	4,5	7		AH3236H	5,25
	180	170	140	6	25	M190x3					AH3236G	4,77
	180	170	140	6	25	M190x3	M6	4,5	7		AH3236GH	4,69
	180	170	154	6	26	M200x3					AH2336	5,99
	180	170	154	6	26	M200x3	M6	4,5	7		AH2336H	5,91
	180	170	154	6	26	M190x3					AH2336G	5,4
	180	170	154	6	26	M190x3	M6	4,5	7		AH2336GH	5,32
	180	170	176	6	26	M200x3					AH3336	7,04
180	190	180	51	5	13	M200x3					AH3838	1,6
	190	180	66	5	13	M200x3					AH3938	2,02
	190	180	73	5	17	Tr205x4					AH238	2,52
	190	180	73	5	17	M200x3					AH238G	2,3
	190	180	96	6	18	Tr205x4					AH3038	3,36
	190	180	96	6	18	Tr205x4	M6	4,2	7		AH3038H	3,28
	190	180	96	6	18	M200x3					AH3038G	3,16
	190	180	96	6	18	M200x3	M6	4,2	7		AH3038GH	3,08



Manguitos de desmontaje FAG

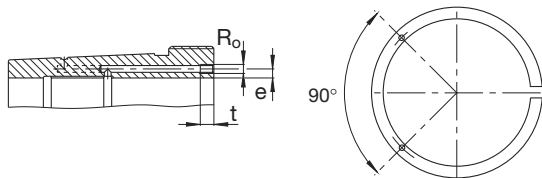

Manguito de desmontaje hidráulico
(sufijo H)

Eje	Dimensiones									Denominación abreviada	Peso ≈ kg		
	d	d ₁	l	a ≈	b	d ₂	R _o	e	t			Manguito de desmontaje FAG	
180	190	180	118	13	18	M200x3					AH24038	3,46	
	190	180	112	5	18	Tr210x4					AH2238	4,21	
	190	180	112	5	18	Tr210x4	M6	4,5	7		AH2238H	4,13	
	190	180	112	5	18	M200x3					AH2238G	3,8	
	190	180	112	5	18	M200x3	M6	4,5	7		AH2238GH	3,72	
	190	180	125	6	20	Tr210x4					AH3138	4,84	
	190	180	125	6	20	Tr210x4	M6	4,5	7		AH3138H	4,75	
	190	180	125	6	20	M200x3					AH3138G	4,38	
	190	180	146	13	18	M200x3					AH24138	4,37	
	190	180	145	7	25	Tr210x4					AH3238	5,88	
	190	180	145	7	25	Tr210x4	M6	4,5	7		AH3238H	5,8	
	190	180	145	7	25	M200x3					AH3238G	5,3	
	190	180	145	7	25	M200x3	M6	4,5	7		AH3238GH	5,22	
	190	180	160	7	26	Tr210x4					AH2338	6,64	
	190	180	160	7	26	Tr210x4	M6	4,5	7		AH2338H	6,56	
	190	180	160	7	26	M200x3					AH2338G	6,04	
	190	180	160	7	26	M200x3	M6	4,5	7		AH2338GH	5,95	
	190	180	181	7	26	Tr210x4					AH3338	7,71	
	190	200	190	54	6	16	Tr210x4					AH3840	1,84
200		190	77	6	16	Tr210x4					AH3940	2,62	
200		190	77	5	18	Tr215x4					AH240	2,87	
200		190	77	5	18	Tr210x4					AH240G	2,56	
200		190	102	6	19	Tr215x4					AH3040	3,8	
200		190	102	6	19	Tr215x4	M6	4,2	7		AH3040H	3,72	
200		190	102	6	19	Tr210x4					AH3040G	3,57	
200		190	102	6	19	Tr210x4	M6	4,2	7		AH3040GH	3,49	
200		190	127	13	18	Tr210x4					AH24040	3,93	
200		190	127	13	18	Tr210x4	M6	8	7		AH24040H	3,93	
200		190	118	5	19	Tr220x4					AH2240	4,68	
200		190	134	6	21	Tr220x4					AH3140	5,55	
200		190	134	6	21	Tr220x4	M6	4,5	7		AH3140H	5,46	
200		190	158	13	18	Tr210x4					AH24140	5,1	
200		190	153	7	24	Tr220x4					AH3240	6,59	
200		190	153	7	24	Tr220x4	M6	4,5	7		AH3240H	6,5	
200		190	170	7	30	Tr220x4					AH2340	7,59	
200		190	170	7	30	Tr220x4	M6	4,5	7		AH2340H	7,5	
200		190	195	7	30	Tr220x4					AH3340	8,95	
200		220	200	77	6	16	Tr230x4	M8	7,5	12		AH3944H	4,65
		220	200	85	6	18	Tr230x4					AH244G	5,29
		220	200	111	6	20	Tr235x4	G ¹ / ₈	8,5	12		AH3044H	7,29
	220	200	111	6	20	Tr230x4					AH3044G	7,13	
	220	200	111	6	20	Tr230x4	G ¹ / ₈	6,5	12		AH3044GH	7,02	
	220	200	138	14	20	Tr230x4	M6	8	7		AH24044H	8,25	
	220	200	130	6	20	Tr240x4	G ¹ / ₈	8,5	12		AH2244H	9,1	
	220	200	145	6	23	Tr240x4	G ¹ / ₈	8,5	12		AH3144H	10,4	
	220	200	170	14	20	Tr230x4	M6	8	7		AH24144H	10,2	
	220	200	181	8	30	Tr240x4	G ¹ / ₈	8,5	12		AH2344H	13,5	

Bajo demanda también son suministrables otras ejecuciones; no duden en contactarnos.
Ver página 581 hasta 585 para saber la tuerca correspondiente

Manguitos de desmontaje FAG

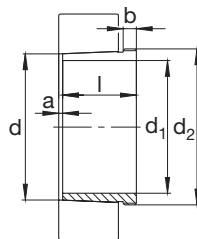

Cono 1:12

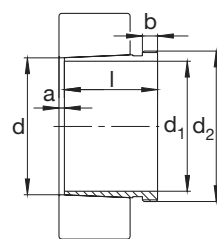
 AH240, AH241
 Cono 1:30

Eje	Dimensiones										Denominación abreviada	Peso ≈
	d	d ₁	l	a ≈	b	d ₂	R _o	e	t	Manguito de desmontaje FAG		
mm												kg
220	240	220	77	6	16	Tr250x4	M8	7,5	12		AH3948H	5,29
	240	220	116	7	21	Tr260x4	G ¹ / ₈	8,5	12		AH3048H	8,75
	240	220	138	15	20	Tr250x4	M6	8	7		AH24048H	8,86
	240	220	144	6	21	Tr260x4	G ¹ / ₈	8,5	12		AH2248H	11,1
	240	220	154	7	25	Tr260x4	G ¹ / ₈	8,5	12		AH3148H	12
	240	220	180	15	20	Tr260x4	G ¹ / ₈	8,5	12		AH24148H	12,5
	240	220	189	8	30	Tr260x4	G ¹ / ₈	8,5	12		AH2348H	15,4
240	260	240	94	6	18	Tr275x4	M8	7,5	12		AH3952H	7,16
	260	240	94	6	18	Tr280x4					AH3952G	7,58
	260	240	128	7	23	Tr280x4	G ¹ / ₈	8,5	12		AH3052H	10,7
	260	240	162	16	20	Tr270x4	M6	8	7		AH24052H	11,8
	260	240	162	16	20	Tr280x4					AH24052G	12,3
	260	240	155	6	23	Tr290x4	G ¹ / ₈	8,5	12		AH2252H	14
	260	240	155	6	23	Tr280x4					AH2252G	13,3
	260	240	172	7	26	Tr290x4	G ¹ / ₈	7	12		AH3152H	15,7
	260	240	172	7	26	Tr280x4					AH3152G	15,1
	260	240	172	7	26	Tr280x4	G ¹ / ₈	7	12		AH3152GH	14,9
	260	240	202	16	22	Tr280x4	G ¹ / ₈	8,5	12		AH24152H	15,4
	260	240	205	8	30	Tr290x4	G ¹ / ₈	8,5	12		AH2352H	19,5
	260	240	205	8	30	Tr280x4					AH2352G	18,7
	260	240	205	8	30	Tr280x4	G ¹ / ₈	8,5	12		AH2352GH	18,5
260	280	260	94	6	18	Tr300x4					AH3956G	8,19
	280	260	131	8	24	Tr300x4	G ¹ / ₈	8,5	12		AH3056H	11,7
	280	260	162	17	22	Tr290x4	M6	8	7		AH24056H	12,4
	280	260	162	17	22	Tr300x4					AH24056G	13,3
	280	260	162	17	22	Tr300x4	M6	8	7		AH24056GH	13,2
	280	260	155	8	24	Tr310x5	G ¹ / ₈	8,5	12		AH2256H	15,2
	280	260	155	8	23	Tr300x4					AH2256G	14,4
	280	260	175	8	28	Tr310x5	G ¹ / ₈	8,5	12		AH3156H	17,4
	280	260	175	8	28	Tr300x4					AH3156G	16,7
	280	260	175	8	28	Tr300x4	G ¹ / ₈	8,5	12		AH3156GH	16,5
	280	260	202	17	22	Tr300x4	G ¹ / ₈	8,5	12		AH24156H	16,3
	280	260	212	8	30	Tr310x5	G ¹ / ₈	8,5	12		AH2356H	21,8
	280	260	212	8	30	Tr300x4					AH2356G	21
	280	260	212	8	30	Tr300x4	G ¹ / ₈	8,5	12		AH2356GH	20,8
280	300	280	112	7	21	Tr315x5	M8	7,5	12		AH3960H	10,1
	300	280	112	7	21	Tr320x5					AH3960G	10,7
	300	280	112	7	21	Tr320x5	M8	7,5	12		AH3960GH	10,5
	300	280	145	8	26	Tr320x5	G ¹ / ₈	8,5	12		AH3060H	14,4
	300	280	184	18	24	Tr310x5	M6	8	7		AH24060H	15,3
	300	280	184	18	24	Tr320x5					AH24060G	16,4
	300	280	170	8	26	Tr330x5	G ¹ / ₈	8,5	12		AH2260H	18
	300	280	170	8	26	Tr320x5					AH2260G	17,2
	300	280	170	8	26	Tr320x5	G ¹ / ₈	8,5	12		AH2260GH	17
	300	280	192	8	30	Tr330x5	G ¹ / ₈	8,5	12		AH3160H	20,8
	300	280	192	8	30	Tr320x5					AH3160G	19,9
	300	280	192	8	30	Tr320x5	G ¹ / ₈	8,5	12		AH3160GH	19,7
	300	280	224	18	24	Tr320x5	G ¹ / ₈	8,5	12		AH24160H	20



Manguitos de desmontaje FAG

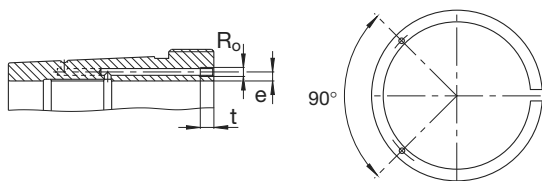

Manguito de desmontaje hidráulico (sufijo H)

Eje	Dimensiones									Denominación abreviada	Peso ≈
	d	d ₁	l	a ≈	b	d ₂	R _o	e	t		
280	300	280	228	8	34	Tr330x5	G ¹ / ₈	8,5	12	AH3260H	26
	300	280	228	8	34	Tr320x5				AH3260G	24,6
300	320	300	112	7	21	Tr340x5				AH3964G	11,4
	320	300	149	8	27	Tr345x5	G ¹ / ₈	8,5	12	AH3064H	16,1
	320	300	149	8	27	Tr340x5				AH3064G	15,8
	320	300	149	8	27	Tr340x5	G ¹ / ₈	8,5	12	AH3064GH	15,6
	320	300	184	18	24	Tr330x5	M6	8	7	AH24064H	16,6
	320	300	184	18	24	Tr340x5				AH24064G	17,5
	320	300	180	10	27	Tr350x5	G ¹ / ₈	8,5	12	AH2264H	20,6
	320	300	180	10	27	Tr340x5				AH2264G	19,8
	320	300	180	10	27	Tr340x5	G ¹ / ₈	8,5	12	AH2264GH	19,6
	320	300	209	8	31	Tr350x5	G ¹ / ₈	8,5	12	AH3164H	24,6
	320	300	209	8	31	Tr340x5				AH3164G	23,6
	320	300	209	8	31	Tr340x5	G ¹ / ₈	8,5	12	AH3164GH	23,4
	320	300	242	18	24	Tr340x5	G ¹ / ₈	8,5	12	AH24164H	21,4
	320	300	246	8	36	Tr350x5	G ¹ / ₈	8,5	12	AH3264H	30,1
	320	300	246	8	36	Tr340x5				AH3264G	28,9
	320	300	246	8	36	Tr340x5	G ¹ / ₈	8,5	12	AH3264GH	28,7
320	340	320	112	7	21	Tr355x5	M8	7,5	12	AH3968H	11,4
	340	320	112	7	21	Tr360x5				AH3968G	12,1
	340	320	162	9	28	Tr365x5	G ¹ / ₈	8,5	12	AH3068H	18,9
	340	320	162	9	28	Tr360x5				AH3068G	18,6
	340	320	162	9	28	Tr360x5	G ¹ / ₈	8,5	12	AH3068GH	18,3
	340	320	206	19	26	Tr360x5	G ¹ / ₈	8,5	12	AH24068H	21,7
	340	320	225	9	33	Tr370x5	G ¹ / ₈	8,5	12	AH3168H	28,7
	340	320	225	9	33	Tr360x5				AH3168G	27,6
	340	320	269	19	26	Tr360x5	G ¹ / ₈	8,5	12	AH24168H	27,1
	340	320	264	9	38	Tr370x5	G ¹ / ₈	8,5	12	AH3268H	35,2
	340	320	264	9	38	Tr360x5				AH3268G	33,7
	340	360	340	112	7	21	Tr375x5	M8	7,5	12	AH3972H
360		340	112	7	21	Tr380x5				AH3972G	12,8
360		340	112	7	21	Tr380x5	M8	7,5	12	AH3972GH	12,6
360		340	167	9	30	Tr385x5	G ¹ / ₈	8,5	12	AH3072H	20,8
360		340	167	9	30	Tr380x5				AH3072G	20,4
360		340	167	9	30	Tr380x5	G ¹ / ₈	8,5	12	AH3072GH	20,1
360		340	206	20	26	Tr380x5	G ¹ / ₈	8,5	12	AH24072H	22,7
360		340	229	9	35	Tr400x5	G ¹ / ₈	8,5	12	AH3172H	32,7
360		340	229	9	35	Tr380x5				AH3172G	29,9
360		340	229	9	35	Tr380x5	G ¹ / ₈	8,5	12	AH3172GH	29,5
360		340	269	20	26	Tr380x5	G ¹ / ₈	8,5	12	AH24172H	29,6
360		340	274	9	40	Tr400x5	G ¹ / ₈	8,5	12	AH3272H	40,8
360		340	274	9	40	Tr380x5				AH3272G	37,5
360		340	274	9	40	Tr380x5	G ¹ / ₈	8,5	12	AH3272GH	37,1
360	380	360	130	8	22	Tr395x5	M8	7,5	12	AH3976H	15,2
	380	360	130	8	22	Tr400x5				AH3976G	16
	380	360	130	8	22	Tr400x5	M8	7,5	12	AH3976GH	15,7
	380	360	170	10	31	Tr410x5	G ¹ / ₈	8,5	12	AH3076H	23,2

Bajo demanda también son suministrables otras ejecuciones; no duden en contactarnos. Ver página 581 hasta 585 para saber la tuerca correspondiente

Manguitos de desmontaje FAG

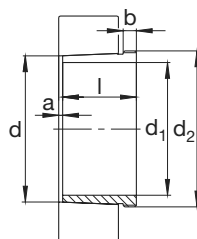

Cono 1:12

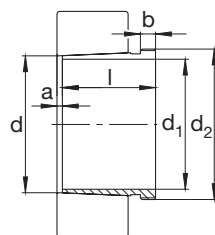
 AH240, AH241
 Cono 1:30

Eje	Dimensiones										Denominación abreviada	Peso ≈ kg	
	d	d ₁	l	a ≈	b	d ₂	R _o	e	t	Manguito de desmontaje FAG			
360	380	360	170	10	31	Tr400x5					AH3076G	22,1	
	380	360	208	20	28	Tr400x5	G ¹ / ₈	8,5	12		AH24076H	23,7	
	380	360	232	10	36	Tr420x5	G ¹ / ₈	8,5	12		AH3176H	35,7	
	380	360	232	10	36	Tr400x5					AH3176G	32,2	
	380	360	271	20	28	Tr400x5	G ¹ / ₈	8,5	12		AH24176H	31,3	
	380	360	284	10	42	Tr420x5	G ¹ / ₈	8,5	12		AH3276H	45,6	
	380	360	284	10	42	Tr400x5					AH3276G	41,5	
380	400	380	130	8	22	Tr415x5	M8	7,5	12		AH3980H	16	
	400	380	130	8	22	Tr420x5					AH3980G	16,9	
	400	380	183	10	33	Tr430x5	G ¹ / ₈	8,5	12		AH3080H	27,3	
	400	380	183	10	33	Tr420x5					AH3080G	25,4	
	400	380	228	20	28	Tr420x5	G ¹ / ₈	8,5	12		AH24080H	27,1	
	400	380	240	10	38	Tr440x5	G ¹ / ₈	8,5	12		AH3180H	39,5	
	400	380	240	10	38	Tr420x5					AH3180G	35,3	
	400	380	278	20	28	Tr420x5	G ¹ / ₈	8,5	12		AH24180H	34,5	
	400	380	302	10	44	Tr440x5	G ¹ / ₈	8,5	12		AH3280H	51,4	
	400	380	302	10	44	Tr420x5					AH3280G	47,4	
	400	420	400	130	8	22	Tr435x5	M8	7,5	12		AH3984H	17
420		400	130	8	22	Tr440x5					AH3984G	17,8	
420		400	186	10	34	Tr450x5	G ¹ / ₈	8,5	12		AH3084H	28,6	
420		400	186	10	34	Tr440x5					AH3084G	27,2	
420		400	186	10	34	Tr440x5	G ¹ / ₈	8,5	12		AH3084GH	26,9	
420		400	230	22	30	Tr440x5	G ¹ / ₈	8,5	12		AH24084H	29	
420		400	266	10	40	Tr460x5	G ¹ / ₈	8,5	12		AH3184H	46,1	
420		400	266	10	40	Tr440x5					AH3184G	42,3	
420		400	266	10	40	Tr440x5	G ¹ / ₈	8,5	12		AH3184GH	41,9	
420		400	310	22	30	Tr440x5	G ¹ / ₈	8,5	12		AH24184H	40,3	
420		400	321	10	46	Tr460x5	G ¹ / ₈	8,5	12		AH3284H	58,4	
420		400	321	10	46	Tr440x5					AH3284G	54	
420		400	321	10	46	Tr440x5	G ¹ / ₈	8,5	12		AH3284GH	53,5	
420		440	420	194	11	35	Tr460x5					AHX3088G	30,1
		440	420	194	11	35	Tr460x5	G ¹ / ₈	8,5	12		AHX3088GH	29,6
	440	420	242	22	30	Tr460x5	G ¹ / ₈	8,5	12		AH24088H	31,9	
	440	420	270	11	42	Tr460x5					AHX3188G	45,3	
	440	420	270	11	42	Tr460x5	G ¹ / ₈	8,5	12		AHX3188GH	44,7	
	440	420	310	22	30	Tr460x5	G ¹ / ₈	8,5	12		AH24188H	42,3	
	440	420	330	11	48	Tr460x5					AHX3288G	58,8	
440	460	440	145	8	25	Tr480x5	G ¹ / ₈	8,5	12		AH3992H	22,5	
	460	440	202	11	37	Tr480x5					AHX3092G	33,1	
	460	440	202	11	37	Tr480x5	G ¹ / ₈	8,5	12		AHX3092GH	32,6	
	460	440	250	23	32	Tr480x5	G ¹ / ₈	8,5	12		AH24092H	34,7	
	460	440	285	11	43	Tr480x5					AHX3192G	50,8	
	460	440	285	11	43	Tr480x5	G ¹ / ₈	8,5	12		AHX3192GH	50,2	
	460	440	332	23	32	Tr480x5	G ¹ / ₈	8,5	12		AH24192H	47,4	
	460	440	349	11	50	Tr480x5					AHX3292G	66,2	

Manguitos de desmontaje FAG

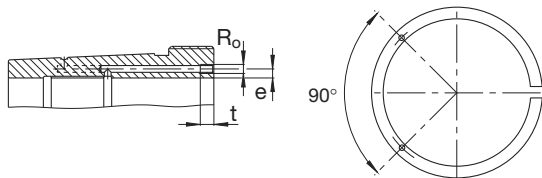
 Manguito de desmontaje hidráulico
 (sufijo H)

Eje	Dimensiones									Denominación abreviada	Peso ≈ kg	
	d	d ₁	l	a ≈	b	d ₂	R _o	e	t			
	mm									Manguito de desmontaje FAG		
460	480	460	158	9	28	Tr500x5	G ¹ / ₈	8,5	12	AH3996H	25,1	
	480	460	205	12	38	Tr500x5				AHX3096G	35,2	
	480	460	250	23	32	Tr500x5	G ¹ / ₈	8,5	12	AH24096H	36,6	
	480	460	295	12	45	Tr500x5				AHX3196G	55,5	
	480	460	295	12	45	Tr500x5	G ¹ / ₈	8,5	12	AHX3196GH	54,9	
	480	460	343	25	35	Tr500x5	G ¹ / ₈	8,5	12	AH24196H	53,1	
	480	460	340	23	32	Tr500x5				AH24196G	53,1	
	480	460	364	12	52	Tr500x5				AHX3296G	73,3	
480	500	480	162	10	32	Tr520x6	G ¹ / ₈	8,5	12	AH39/500H	28	
	500	480	162	10	32	Tr530x6				AH39/500G	29,6	
	500	480	209	12	40	Tr530x6				AHX30/500G	40	
	500	480	253	23	35	Tr520x6	G ¹ / ₈	8,5	12	AH240/500H	39	
	500	480	253	23	35	Tr530x6				AH240/500G	41,8	
	500	480	253	23	35	Tr530x6	G ¹ / ₈	8,5	12	AH240/500GH	41,2	
	500	480	313	12	47	Tr530x6				AHX31/500G	65,3	
	500	480	362	25	37	Tr520x6	G ¹ / ₈	8,5	12	AH241/500H	59	
	500	480	360	23	35	Tr530x6				AH241/500G	61,2	
	500	480	360	23	35	Tr530x6	G ¹ / ₈	8,5	12	AH241/500GH	60,5	
	500	480	393	12	54	Tr530x6				AHX32/500G	88,1	
	500	480	393	12	54	Tr530x6	G ¹ / ₈	8,5	12	AHX32/500GH	87,4	
	500	530	500	175	10	37	Tr550x6	G ¹ / ₄	10	15	AH39/530H	43,4
530		500	175	10	37	Tr560x6	G ¹ / ₄	10	15	AH39/530G	45,3	
530		500	230	12	45	Tr560x6	G ¹ / ₄	15	15	AH30/530AH	61,9	
530		500	290	25	40	Tr550x6	G ¹ / ₄	8,5	15	AH240/530H	66,9	
530		500	285	24	35	Tr560x6				AH240/530G	67,9	
530		500	375	25	40	Tr550x6	G ¹ / ₄	10	15	AH241/530H	88,4	
530		500	370	25	35	Tr560x6				AH241/530G	89,9	
530		500	412	12	57	Tr580x6				AH32/530AG	125	
530		560	530	180	10	37	Tr580x6	G ¹ / ₄	12	15	AH39/560H	46,2
	560	530	180	10	37	Tr600x6				AH39/560G	52,1	
	560	530	180	10	37	Tr600x6	G ¹ / ₄	12	15	AH39/560GH	51,3	
	560	530	240	12	45	Tr590x6	G ¹ / ₄	15	15	AH30/560AH	68,6	
	560	530	240	12	45	Tr600x6				AH30/560AG	71,8	
	560	530	298	25	40	Tr580x6	G ¹ / ₄	8,5	15	AH240/560H	72,3	
	560	530	296	24	38	Tr600x6				AH240/560G	77,8	
	560	530	296	24	38	Tr600x6	G ¹ / ₄	8,5	15	AH240/560GH	76,9	
	560	530	335	12	55	Tr600x6				AH31/560AG	106	
	560	530	400	28	45	Tr580x6	G ¹ / ₄	12	15	AH241/560H	101	
	560	530	393	24	38	Tr600x6				AH241/560G	105	
	560	530	422	12	57	Tr610x6	G ¹ / ₄	12	15	AH32/560AH	144	
	560	530	422	12	57	Tr600x6				AH32/560AG	140	
	570	600	570	192	10	38	Tr625x6	G ¹ / ₄	12	15	AH39/600H	54,6
		600	570	192	10	38	Tr630x6				AH39/600G	57
		600	570	192	10	38	Tr630x6	G ¹ / ₄	12	15	AH39/600GH	56
600		570	245	14	45	Tr630x6	G ¹ / ₄	15	15	AH30/600AH	74,5	
600		570	317	30	45	Tr625x6	G ¹ / ₄	8,5	15	AH240/600H	86	
600		570	310	26	38	Tr630x6				AH240/600G	84,8	

 Bajo demanda también son suministrables otras ejecuciones; no duden en contactarnos.
 Ver página 581 hasta 585 para saber la tuerca correspondiente

Manguitos de desmontaje FAG

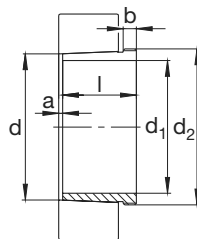

Cono 1:12

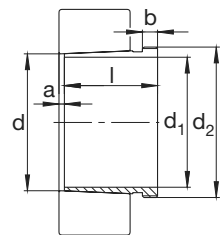
 AH240, AH241
 Cono 1:30

Eje	Dimensiones										Denominación abreviada	Peso ≈ kg
	d	d ₁	l	a ≈	b	d ₂	R _o	e	t	Manguito de desmontaje FAG		
570	600	570	355	14	55	Tr630x6	G ¹ / ₄	12	15		AH31/600AH	118
	600	570	425	30	50	Tr625x6	G ¹ / ₄	12	15		AH241/600H	118
	600	570	413	26	38	Tr630x6					AH241/600G	116
	600	570	413	26	38	Tr630x6	G ¹ / ₄	12	15		AH241/600GH	115
	600	570	445	14	57	Tr630x6					AH32/600AG	157
600	630	600	210	12	40	Tr655x6	G ¹ / ₄	12	15		AH39/630H	62,8
	630	600	210	12	40	Tr655x6					AH39/630G	69,4
	630	600	258	14	46	Tr670x6	G ¹ / ₄	15	15		AH30/630AH	87,8
	630	600	335	30	45	Tr655x6	G ¹ / ₄	8,5	15		AH240/630H	95,5
	630	600	330	26	40	Tr670x6					AH240/630G	98,7
	630	600	375	14	60	Tr670x6	G ¹ / ₄	12	15		AH31/630AH	138
	630	600	450	30	50	Tr655x6	G ¹ / ₄	12	15		AH241/630H	135
	630	600	440	26	40	Tr670x6					AH241/630G	134
	630	600	475	14	63	Tr670x6					AH32/630AG	185
	630	670	630	216	12	41	Tr695x6	G ¹ / ₄	12	15		AH39/670H
670		630	216	12	41	Tr710x7					AH39/670G	92,9
670		630	280	14	50	Tr710x7	G ¹ / ₄	15	15		AH30/670AH	123
670		630	358	30	50	Tr695x6	G ¹ / ₄	8,5	15		AH240/670H	136
670		630	348	26	40	Tr710x7					AH240/670G	138
670		630	467	30	55	Tr695x6	G ¹ / ₄	12	15		AH31/670H	184
670		630	452	26	40	Tr710x7					AH241/670G	182
670		630	452	26	40	Tr710x7	G ¹ / ₄	12	15		AH241/670GH	181
670		630	500	14	62	Tr710x7					AH32/670AG	249
670		710	670	228	12	43	Tr740x7	G ¹ / ₄	15	15		AH39/710H
	710	670	228	12	43	Tr750x7					AH39/710G	105
	710	670	228	12	43	Tr750x7	G ¹ / ₄	15	15		AH39/710GH	103
	710	670	286	16	50	Tr750x7	G ¹ / ₄	15	15		AH30/710AH	21,3
	710	670	365	33	50	Tr740x7	G ¹ / ₄	8,5	15		AH240/710H	150
	710	670	360	26	45	Tr750x7					AH240/710G	153
	710	670	493	33	55	Tr740x7	G ¹ / ₄	15	15		AH241/710H	209
	710	670	483	26	45	Tr750x7					AH241/710G	209
	710	670	515	16	65	Tr750x7					AH32/710AG	275
	680	710	680	163	12	43	Tr740x7	G ¹ / ₄	12	15		AH38/710H
710	750	710	234	12	44	Tr780x7	G ¹ / ₄	15	15		AH39/750H	108
	750	710	234	12	44	Tr800x7					AH39/750G	118
	750	710	234	12	44	Tr800x7	G ¹ / ₄	15	15		AH39/750GH	116
	750	710	385	35	50	Tr780x7	G ¹ / ₄	8,5	15		AH240/750H	170
	750	710	380	28	45	Tr800x7					AH240/750G	175
	750	710	425	16	60	Tr800x7	G ¹ / ₄	15	15		AH31/750AH	236
	750	710	530	35	55	Tr780x7	G ¹ / ₄	15	15		AH241/750H	241
	750	710	520	28	45	Tr800x7					AH241/750G	244
	750	710	520	28	45	Tr800x7	G ¹ / ₄	15	15		AH241/750GH	242



Manguitos de desmontaje FAG

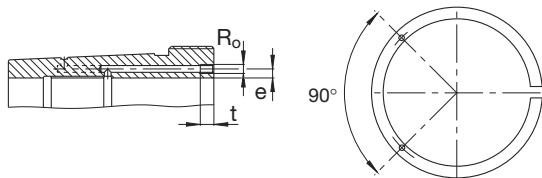

Manguito de desmontaje hidráulico
(sufijo H)

Eje	Dimensiones									Denominación abreviada	Peso ≈ kg
	d	d ₁	l	a ≈	b	d ₂	R ₀	e	t		
750	800	750	245	12	45	Tr830x7	G ¹ / ₄	15	15	AH39/800H	147
	800	750	245	12	45	Tr830x7				AH39/800G	155
	800	750	308	18	53	Tr850x7	G ¹ / ₄	15	15	AH30/800AH	200
	800	750	395	40	50	Tr830x7	G ¹ / ₄	15	15	AH240/800H	223
	800	750	395	28	50	Tr850x7				AH240/800G	233
	800	750	438	18	63	Tr850x7	G ¹ / ₄	15	15	AH31/800AH	299
	800	750	530	40	55	Tr830x7	G ¹ / ₄	15	15	AH241/800H	307
	800	750	525	28	50	Tr850x7				AH241/800G	313
	800	750	525	28	50	Tr850x7	G ¹ / ₄	15	15	AH241/800GH	311
	800	750	550	18	62	Tr850x7				AH32/800AG	396
800	850	800	258	12	50	Tr880x7	G ¹ / ₄	15	15	AH39/850H	164
	850	800	258	12	50	Tr900x7				AH39/850G	176
	850	800	258	12	50	Tr900x7	G ¹ / ₄	15	15	AH39/850GH	174
	850	800	418	40	53	Tr880x7	G ¹ / ₄	15	15	AH240/850H	252
	850	800	415	30	50	Tr900x7				AH240/850G	261
	850	800	560	40	60	Tr880x7	G ¹ / ₄	15	15	AH241/850H	344
	850	800	560	40	60	Tr900x7				AH241/850G	363
850	900	850	265	12	51	Tr930x8	G ¹ / ₄	15	15	AH39/900H	182
	900	850	265	12	51	Tr950x8				AH39/900G	191
	900	850	335	20	55	Tr950x8	G ¹ / ₄	15	15	AH30/900AH	248
	900	850	430	45	55	Tr930x8	G ¹ / ₄	15	15	AH240/900H	276
	900	850	430	45	55	Tr950x8				AH240/900G	291
	900	850	575	45	60	Tr930x8	G ¹ / ₄	15	15	AH241/900H	383
	900	850	575	45	60	Tr950x8				AH241/900G	397
860	900	860	193	12	51	Tr930x8	G ¹ / ₄	15	15	AH38/900H	109
900	950	900	282	15	51	Tr980x8	G ¹ / ₄	15	15	AH39/950H	206
	950	900	282	15	51	Tr1000x8				AH39/950G	216
	950	900	467	45	55	Tr980x8	G ¹ / ₄	15	15	AH240/950H	318
	950	900	467	45	55	Tr1000x8				AH240/950G	335
	950	900	605	45	60	Tr980x8	G ¹ / ₄	15	15	AH241/950H	426
	950	900	605	45	60	Tr1000x8				AH241/950G	443
	950	900	605	45	60	Tr1000x8	G ¹ / ₄	15	15	AH241/950GH	440
950	1000	950	296	15	52	Tr1060x8				AH39/1000G	247
	1000	950	469	50	57	Tr1035x8	G ¹ / ₄	15	15	AH240/1000H	353
	1000	950	469	50	57	Tr1060x8				AH240/1000G	363
	1000	950	525	22	63	Tr1060x8	G ¹ / ₄	15	15	AH31/1000AH	482
	1000	950	645	50	65	Tr1035x8	G ¹ / ₄	15	15	AH241/1000H	482
1000	1060	1000	310	15	52	Tr1095x8	G ¹ / ₄	15	15	AH39/1060H	294
	1060	1000	310	15	52	Tr1120x8				AH39/1060G	313
	1060	1000	498	50	60	Tr1095x8	G ¹ / ₄	15	15	AH240/1060H	440
	1060	1000	498	50	60	Tr1120x8				AH240/1060G	473
	1060	1000	665	50	65	Tr1095x8	G ¹ / ₄	15	15	AH241/1060H	605

Bajo demanda también son suministrables otras ejecuciones; no duden en contactarnos.
Ver página 581 hasta 585 para saber la tuerca correspondiente

Manguitos de desmontaje FAG

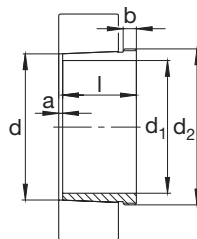
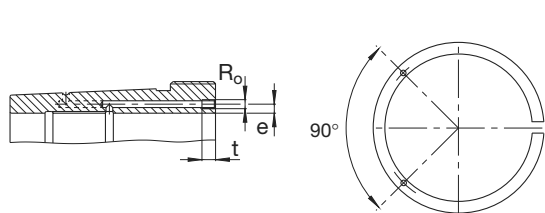

Cono 1:12

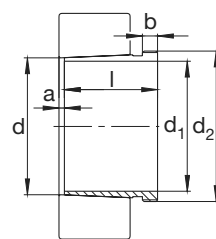
 AH240, AH241
 Cono 1:30

 Manguito de desmontaje hidráulico
 (sufijo H)

Eje	Dimensiones										Denominación abreviada	Peso ≈ kg
	d	d ₁	l	a ≈	b	d ₂	R ₀	e	t	Manguito de desmontaje FAG		
1060	1120	1060	527	50	65	Tr1155x8	G ¹ / ₄	15	15		AH240/1120H	490
	1120	1060	527	50	65	Tr1180x8					AH240/1120G	533
	1120	1060	705	50	75	Tr1180x8	G ¹ / ₄	15	15		AH241/1120H	727
1070	1120	1070	310	15	52	Tr1180x8					AH39/1120G	291
1120	1180	1120	540	50	65	Tr1215x8	G ¹ / ₄	15	15		AH240/1180H	530
	1180	1120	540	50	65	Tr1250x8					AH240/1180G	586
1130	1180	1130	330	15	55	Tr1215x8	G ¹ / ₄	15	15		AH39/1180H	306
	1180	1130	330	15	55	Tr1250x8					AH39/1180G	337
1180	1250	1180	570	50	70	Tr1285x8	G ¹ / ₄	15	15		AH240/1250H	680
	1250	1180	570	50	70	Tr1320x8					AH240/1250G	743
1200	1250	1200	340	18	55	Tr1320x8					AH39/1250G	370
1250	1320	1250	600	50	70	Tr1355x8	G ¹ / ₄	15	15		AH240/1320H	760
	1320	1250	600	50	70	Tr1400x8					AH240/1320G	840
1270	1320	1270	360	18	55	Tr1400x8					AH39/1320G	425
1320	1400	1320	615	50	70	Tr1435x8	G ¹ / ₄	15	15		AH240/1400H	930
	1400	1320	615	50	70	Tr1500x8					AH240/1400G	1040
1350	1400	1350	380	20	60	Tr1500x8					AH39/1400G	504
1450	1500	1450	400	20	60	Tr1600x8					AH39/1500G	569

Tuercas ranuradas FAG

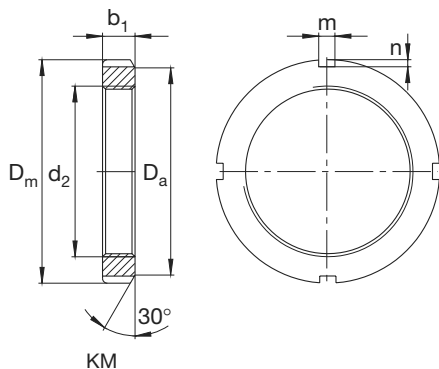

Rosca	Dimensiones					Peso ≈ Tuerca kg	Denominación abreviada	
	D _m mm	b ₁	D _a	m	n		Tuerca FAG	Elemento de seguridad apropiado FAG
M10x0,75	18	4	13,5	3	2	0,005	KM0	MB0
M12x1	22	4	17	3	2	0,005	KM1	MB1, MB1A
M15x1	25	5	21	4	2	0,01	KM2	MB2, MB2A
M17x1	28	5	24	4	2	0,015	KM3	MB3, MB3A
M20x1	32	6	26	4	2	0,02	KM4	MB4, MB4A
M25x1,5	38	7	32	5	2	0,03	KM5	MB5, MB5A
M30x1,5	45	7	38	5	2	0,04	KM6	MB6, MB6A
M35x1,5	52	8	44	5	2	0,065	KM7	MB7, MB7A
M40x1,5	58	9	50	6	2,5	0,085	KM8	MB8, MB8A
M45x1,5	65	10	56	6	2,5	0,12	KM9	MB9, MB9A
M50x1,5	70	11	61	6	2,5	0,15	KM10	MB10, MB10A
M55x2	75	11	67	7	3	0,16	KM11	MB11, MB11A
M60x2	80	11	73	7	3	0,175	KM12	MB12, MB12A
M65x2	85	12	79	7	3	0,22	KM13	MB13, MB13A
M70x2	92	12	85	8	3,5	0,255	KM14	MB14, MB14A
M75x2	98	13	90	8	3,5	0,3	KM15	MB15, MB15A
M80x2	105	15	95	8	3,5	0,4	KM16	MB16, MB16A
M85x2	110	16	102	8	3,5	0,46	KM17	MB17, MB17A
M90x2	120	16	108	10	4	0,575	KM18	MB18, MB18A

Bajo demanda también son suministrables otras ejecuciones; no duden en contactarnos.

Tuercas ranuradas FAG

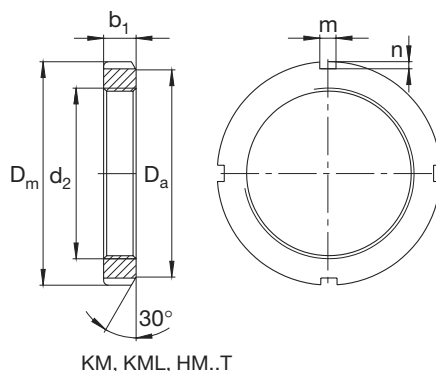

Rosca	Dimensiones					Peso ≈ Tuerca kg	Denominación abreviada	
	D _m mm	b ₁	D _a	m	n		Tuerca FAG	Elemento de seguridad apropiado FAG
M95x2	125	17	113	10	4	0,645	KM19	MB19, MB19A
M100x2	130	18	120	10	4	0,725	KM20	MB20, MB20A
M105x2	140	18	126	12	5	0,87	KM21	MB21
M110x2	145	19	133	12	5	0,97	KM22	MB22
M115x2	150	19	137	12	5	1,01	KM23	MB23
M120x2	145	20	135	12	5	0,79	KML24	MBL24
M120x2	155	20	138	12	5	1,08	KM24	MB24
M125x2	160	21	148	12	5	1,22	KM25	MB25
M130x2	155	21	145	12	5	0,9	KML26	MBL26
M130x2	165	21	149	12	5	1,24	KM26	MB26
M135x2	175	22	160	14	6	1,55	KM27	MB27
M140x2	165	22	155	12	5	1,01	KML28	MBL28
M140x2	180	22	160	14	6	1,56	KM28	MB28
M145x2	190	24	171	14	6	2,05	KM29	MB29
M150x2	180	24	170	14	5	1,44	KML30	MBL30
M150x2	195	24	171	14	6	2,06	KM30	MB30
M155x3	200	25	182	16	7	2,27	KM31	MB31
M160x3	190	25	180	14	5	1,62	KML32	MBL32
M160x3	210	25	182	16	7	2,52	KM32	MB32
M165x3	210	26	193	16	7	2,7	KM33	MB33
M170x3	200	26	190	16	5	1,72	KML34	MBL34
M170x3	220	26	193	16	7	2,8	KM34	MB34



Tuercas ranuradas FAG

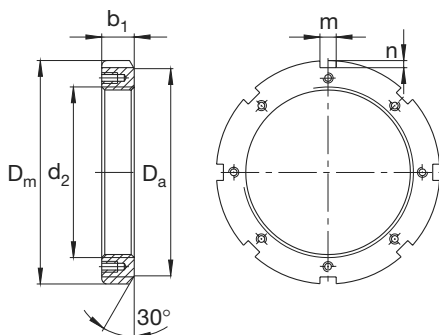

HM30, HM31

Rosca	Dimensiones					Peso ≈ Tuerca kg	Denominación abreviada	
	D _m mm	b ₁	D _a	m	n		Tuerca FAG	Elemento de seguridad apropiado FAG
M180x3	210	27	200	16	5	1,96	KML36	MBL36
M180x3	230	27	203	18	8	3,04	KM36	MB36
M190x3	220	28	210	16	5	2,13	KML38	MBL38
M190x3	240	28	214	18	8	3,34	KM38	MB38
M200x3	240	29	222	18	8	2,9	KML40	MBL40
M200x3	250	29	226	18	8	3,69	KM40	MB40
Tr220x4	260	30	242	20	9	3,21	HM3044	MS3044
Tr220x4	280	32	250	20	10	5,3	HM44T	MB44
Tr240x4	290	34	270	20	10	5,12	HM3048	MS3048
Tr240x4	300	34	270	20	10	6,15	HM48T	MB48
Tr260x4	310	34	290	20	10	5,54	HM3052	MS3048
Tr260x4	330	35	300	24	12	8,05	HM52T	MB52
Tr280x4	330	38	310	24	10	6,61	HM3056	MS3056
Tr280x4	350	36	320	24	12	8,9	HM56T	MB56
Tr300x4	360	42	336	24	12	9,48	HM3060	MS3060
Tr300x4	380	40	340	24	12	11,4	HM3160	MS3160
Tr320x5	380	42	356	24	12	10,1	HM3064	MS3064
Tr320x5	400	42	360	24	12	12,8	HM3164	MS3164
Tr340x5	400	45	376	24	12	11,5	HM3068	MS3064
Tr340x5	440	55	400	28	15	23	HM3168	MS3168
Tr360x5	420	45	394	28	13	11,9	HM3072	MS3072
Tr360x5	460	58	420	28	15	25,7	HM3172	MS3168
Tr380x5	450	48	422	28	14	15,9	HM3076	MS3076
Tr380x5	490	60	440	32	18	30	HM3176	MS3168
Tr400x5	470	52	442	28	14	18,2	HM3080	MS3076
Tr400x5	520	62	460	32	18	35,7	HM3180	MS3180
Tr420x5	490	52	462	32	14	18,9	HM3084	MS3084
Tr420x5	540	70	490	32	18	43,4	HM3184	MS3180

Bajo demanda también son suministrables otras ejecuciones; no duden en contactarnos.

Tuercas ranuradas FAG

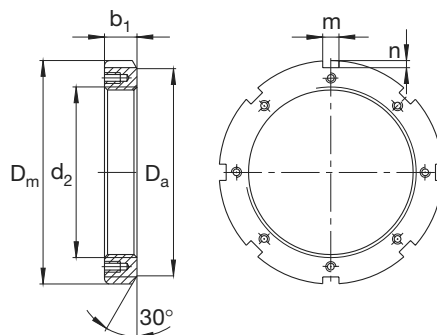

HM30, HM31

Rosca	Dimensiones					Peso ≈ Tuerca kg	Denominación abreviada	
	D _m mm	b ₁	D _a	m	n		Tuerca FAG	Elemento de seguridad apropiado FAG
Tr440x5	520	60	490	32	15	26,5	HM3088	MS3088
Tr440x5	560	70	510	36	20	44,3	HM3188	MS3188
Tr460x5	540	60	510	32	15	27,7	HM3092	MS3088
Tr460x5	580	75	540	36	20	53,8	HM3192	MS3188
Tr480x5	560	60	530	36	15	28,7	HM3096	MS3096
Tr480x5	620	75	560	36	20	62,2	HM3196	MS3196
Tr500x5	580	68	550	36	15	34	HM30/500	MS3096
Tr500x5	630	80	580	40	23	62,1	HM31/500	MS31/500
Tr530x6	630	68	590	40	20	44,7	HM30/530	MS30/530
Tr530x6	670	80	610	40	23	71,2	HM31/530	MS31/530
Tr560x6	650	75	610	40	20	46,2	HM30/560	MS30/560
Tr560x6	710	85	650	45	25	85,6	HM31/560	MS31/560
Tr600x6	700	75	660	40	20	55,9	HM30/600	MS30/530
Tr600x6	750	85	690	45	25	91,7	HM31/600	MS31/560
Tr630x6	730	75	690	45	20	58,3	HM30/630	MS30/630
Tr630x6	800	95	730	50	28	122	HM31/630	MS31/630
Tr670x6	780	80	740	45	20	73,8	HM30/670	MS30/670
Tr670x6	850	106	775	50	28	156	HM31/670	MS31/670
Tr710x7	830	90	780	50	25	94,8	HM30/710	MS30/710
Tr710x7	900	106	825	55	30	173	HM31/710	MS31/710
Tr750x7	870	90	820	55	25	99,5	HM30/750	MS30/750
Tr750x7	950	112	875	60	34	202	HM31/750	MS31/750
Tr800x7	920	90	870	55	25	106	HM30/800	MS30/750
Tr800x7	1000	112	925	60	34	215	HM31/800	MS31/750
Tr850x7	980	90	925	60	25	113	HM30/850	MS30/850
Tr850x7	1060	118	975	70	38	246	HM31/850	MS31/850
Tr900x7	1030	100	975	60	25	135	HM30/900	MS30/850
Tr900x7	1120	125	1030	70	38	293	HM31/900	MS31/900



Tuercas ranuradas FAG

Rosca	Dimensiones					Peso ≈ Tuerca kg	Denominación abreviada	
	D _m mm	b ₁	D _a	m	n		Tuerca FAG	Elemento de seguridad apropiado FAG
Tr950x8	1080	100	1025	60	25	143	HM30/950	MS30/950
Tr950x8	1170	125	1080	70	38	310	HM31/950	MS31/950
Tr1000x8	1140	100	1085	60	25	165	HM30/1000	MS30/1000
Tr1000x8	1240	125	1140	70	38	361	HM31/1000	MS31/1000
Tr1060x8	1200	100	1145	60	25	175	HM30/1060	MS30/1000
Tr1060x8	1300	125	1210	70	38	386	HM31/1060	MS31/1000
Tr1120x8	1260	100	1205	60	25	185	HM30/1120	MS30/1000
Tr1120x8	1360	125	1270	70	38	427	HM31/1120	MS31/1000
Tr1180x8	1320	100	1265	60	25	196	HM30/1180	MS30/1000
Tr1180x8	1420	125	1330	70	38	459	HM31/1180	MS31/1000
Tr1250x8	1390	110	1335	60	25	233	HM30/1250	MS30/1000
Tr1250x8	1490	125	1400	70	38	485	HM31/1250	MS31/1000
Tr1320x8	1460	110	1405	60	25	245	HM30/1320	MS30/1000
Tr1320x8	1560	125	1470	70	38	511	HM31/1320	MS31/1000
Tr1400x8	1540	110	1485	60	25	259	HM30/1400	MS30/1000
Tr1400x8	1640	130	1550	70	38	562	HM31/1400	MS31/1000
Tr1500x8	1650	110	1595	60	25	297	HM30/1500	MS30/1000
Tr1500x8	1740	130	1650	70	38	601	HM31/1500	MS31/1000

Bajo demanda también son suministrables otras ejecuciones; no duden en contactarnos.

Chapas de seguridad FAG

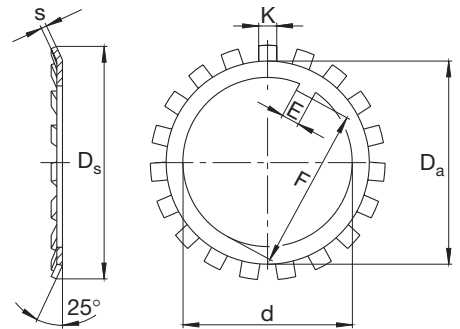

Denominación abreviada Chapa de seguridad	Dimensiones							Peso
	d	D _s ≈	D _a	s ¹⁾	E ²⁾	F	K	100 piezas
FAG	mm							kg
MB0	10	21	13,5	1	3	8,5	3	0,13
MB1	12	25	17	1	3	10,5	3	0,192
MB1A	12	25	17	1,2	3	10,5	3	0,23
MB2	15	28	21	1	4	13,5	4	0,253
MB2A	15	28	21	1,2	4	13,5	4	0,31
MB3	17	32	24	1	4	15,5	4	0,313
MB3A	17	32	24	1,2	4	15,5	4	0,38
MB4	20	36	26	1	4	18,5	4	0,35
MB4A	20	36	26	1,2	4	18,5	4	0,4
MB5	25	42	32	1,25	5	23	5	0,64
MB5A	25	42	32	1,8	5	23	5	0,9
MB6	30	49	38	1,25	5	27,5	5	0,78
MB6A	30	49	38	1,8	5	27,5	5	1,1
MB7	35	57	44	1,04	6	32,5	5	1,04
MB7A	35	57	44	1,85	6	32,5	5	1,5
MB8	40	62	50	1,25	6	37,5	6	1,23
MB8A	40	62	50	1,8	6	37,5	6	1,8
MB9	45	69	56	1,25	6	42,5	6	1,52
MB9A	45	69	56	1,8	6	42,5	6	2,2
MB10	50	74	61	1,25	6	47,5	6	1,6
MB10A	50	74	61	1,8	6	47,5	6	2,3
MB11	55	81	67	1,5	8	52,5	7	1,96
MB11A	55	81	67	2,5	8	52,5	7	3,9
MB12	60	86	73	1,5	8	57,5	7	2,53
MB12A	60	86	73	2,5	8	57,5	7	4,2
MB13	65	92	79	1,5	8	62,5	7	2,9
MB13A	65	92	79	2,5	8	62,5	7	4,8



Chapas de seguridad FAG

Denominación abreviada Chapa de seguridad	Dimensiones							Peso ≈ 100 piezas kg
	d mm	D _s ≈	D _a	s ¹⁾	E ²⁾	F	K	
FAG	mm							kg
MB14	70	98	85	1,5	8	66,5	8	3,34
MB14A	70	98	85	2,5	8	66,5	8	5,6
MB15	75	104	90	1,5	8	71,5	8	3,56
MB15A	75	104	90	2,5	8	71,5	8	5,9
MB16	80	112	95	1,8	10	76,5	8	4,64
MB16A	80	112	95	2,5	10	76,5	8	6,6
MB17	85	119	102	1,8	10	81,5	8	5,24
MB17A	85	119	102	2,5	10	81,5	8	7,5
MB18	90	126	108	1,8	10	86,5	10	6,23
MB18A	90	126	108	2,5	10	86,5	10	8,9
MB19	95	133	113	1,8	10	91,5	10	6,7
MB19A	95	133	113	2,5	10	91,5	10	9,6
MB20	100	142	120	1,8	12	96,5	10	7,65
MB20A	100	142	120	2,5	12	96,5	10	10,9
MB21	105	145	126	1,75	12	100,5	12	8,26
MB22	110	154	133	1,75	12	105,5	12	9,4
MB23	115	159	137	2	12	110,5	12	10,8
MBL24	120	151	135	2	14	115	12	7,7
MB24	120	164	138	2	14	115	12	10,5
MB25	125	170	148	2	14	120	12	11,8
MBL26	130	161	145	2	14	125	12	8,7
MB26	130	175	149	2	14	125	12	11,3
MB27	135	185	160	2	14	130	14	14,4
MBL28	140	171	155	2	16	135	12	10,9
MB28	140	192	160	2	16	135	14	14,2

Chapas de seguridad FAG

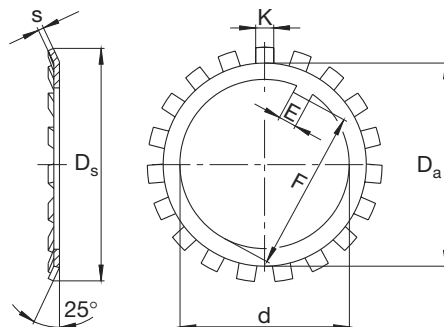

Denominación abreviada Chapa de seguridad	Dimensiones							Peso
	d	D _s ≈	D _a	s ¹⁾	E ²⁾	F	K	100 piezas
FAG	mm							kg
MB29	145	202	171	2	16	140	14	16,8
MBL30	150	188	170	2	16	145	14	11,3
MB30	150	205	171	2	16	145	14	15,5
MB31	155	212	182	2,5	16	147,5	16	20,9
MBL32	160	199	180	2,5	18	154	14	16,2
MB32	160	217	182	2,5	18	154	16	22,2
MB33	165	222	193	2,5	18	157,5	16	24,1
MBL34	170	211	190	2,5	18	164	16	17
MB34	170	232	193	2,5	18	164	16	24,7
MBL36	180	221	200	2,5	20	174	16	18
MB36	180	242	203	2,5	20	174	18	26,8
MBL38	190	231	210	2,5	20	184	16	20,5
MB38	190	252	214	2,5	20	184	18	27,8
MBL40	200	248	222	2,5	20	194	18	21,4
MB40	200	262	226	2,5	20	194	18	29,3
MB44	220	292	250	3	24	213	20	40
MB48	240	312	270	3	24	233	20	40
MB52	260	342	300	3	28	253	24	60
MB56	280	362	320	3	28	273	24	62

Grapas de seguridad FAG con tornillo hexagonal

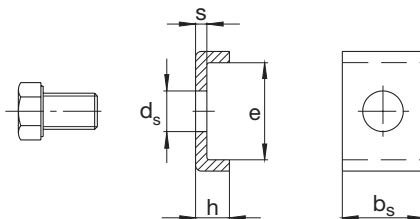
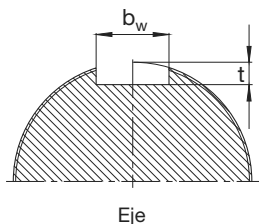

Hasta rosca M16:
Tornillo autoblocante
A partir de rosca M20:
Tornillo hexagonal normalizado con elemento de seguridad

Designación abreviada Grapa de seguridad completa FAG	Dimensiones					Tornillo hexagonal Autoblocante	Par de apriete Nm	Ranura del eje		Peso ≈ kg
	s	b _s	h	d _s	e			b _w	t	
MS3044	4	20	12	7	13,5	M6x10	10	22	9	0,026
MS3144	4	20	12	9	22,5	M8x16	25	22	9	0,038
MS3048	4	20	12	9	17,5	M8x16	25	22	9	0,035
MS3152	4	24	12	11	25,5	M10x20	51	26	9	0,056
MS3056	4	24	12	9	17,5	M8x16	25	26	9	0,04
MS3060	4	24	12	9	20,5	M8x16	25	26	9	0,043
MS3160	4	24	12	12	30,5	M10x20	51	26	9	0,059
MS3064	5	24	15	9	21	M8x16	25	26	10	0,057
MS3164	5	24	15	12	31	M10x20	51	26	10	0,074
MS3168	5	28	15	14	38	M12x22	87	30	10	0,115
MS3072	5	28	15	9	20	M8x16	25	30	10	0,064
MS3076	5	28	15	12	24	M10x20	51	30	10	0,076
MS3176	5	32	15	14	40	M12x22	87	34	10	0,115
MS3180	5	32	15	18	45	M16x25	215	34	10	0,154
MS3084	5	32	15	12	24	M10x20	51	34	10	0,085
MS3088	5	32	15	14	28	M12x22	87	34	10	0,1
MS3188	5	36	15	18	43	M16x25	215	38	10	0,163
MS3096	5	36	15	14	28	M12x22	87	38	12	0,109
MS3196	5	36	15	18	53	M16x25	215	38	12	0,177
MS31/500	5	40	15	18	45	M16x25	215	42	12	0,178
MS30/530	7	40	21	18	34	M16x25	215	42	14	0,223
MS31/530	7	40	21	22	51	M20x40	430	42	14	0,347

Grapas de seguridad FAG con tornillo hexagonal

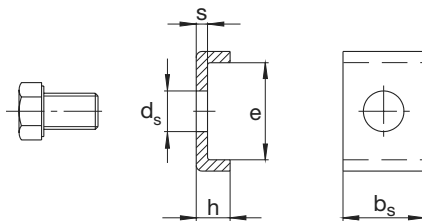
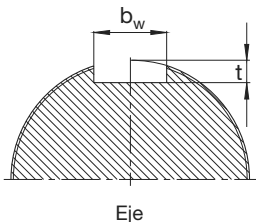

Hasta rosca M16:
Tornillo autoblocante
A partir de rosca M20:
Tornillo hexagonal normalizado con elemento de seguridad

Designación abreviada Grapa de seguridad completa FAG	Dimensiones					Tornillo hexagonal	Par de apriete	Ranura del eje		Peso ≈ kg
	s	b _s	h	d _s	e			b _w	t	
MS30/560	7	40	21	18	29	M16x25	215	42	14	0,212
MS31/560	7	45	21	22	54	M20x40	430	47	14	0,38
MS30/630	7	45	21	18	34	M16x25	215	47	14	0,244
MS31/630	7	50	21	22	61	M20x40	430	52	15	0,426
MS30/670	7	45	21	18	39	M16x25	215	47	14	0,257
MS31/670	7	50	21	22	66	M20x40	430	52	15	0,439
MS30/710	7	50	21	18	39	M16x25	215	52	15	0,279
MS31/710	7	55	21	26	69	M24x45	740	57	15	0,58
MS30/750	7	55	21	18	39	M16x25	215	57	15	0,301
MS31/750	7	60	21	26	70	M24x45	740	62	15	0,614
MS30/850	7	60	21	22	44	M20x40	430	62	15	0,426
MS31/850	7	70	21	26	71	M24x45	740	72	16	0,679
MS31/900	7	70	21	26	76	M24x45	740	72	16	0,698
MS30/950	7	60	21	22	46	M20x40	430	62	16	0,433
MS31/950	7	70	21	26	78	M24x45	740	72	16	0,706
MS30/1000	7	60	21	22	51	M20x40	430	62	16	0,449
MS31/1000	7	70	21	26	88	M24x45	740	72	16	0,744
MS30/1500	7	60	21	22	56	M20x40	430	62	16	0,466



RODAVIGO, S.A.
RODAMIENTOS VIGO, S.A.

www.rodavigo.net

+34 986 288118
Servicio de Att. al Cliente

