



FYH®

CORROSION RESISTANT UNITS

STAINLESS UNITS

THERMOPLASTIC UNITS

NICKEL-PLATED UNITS



CATALOG NO.8500E





The **Corrosion Resistant Series** is available in a wide array of sizes and styles, and units may be customized with a number of different specialized options to accommodate virtually any application. Federal compliance can be assured with **FYH Bearing Units**.

S6

STAINLESS INSERT



- | | |
|--------------------------|---------------------------------------|
| RINGS | Stainless steel (SUS 440C equivalent) |
| BALLS | SUS 440C |
| CAGE | SUS304 |
| GREASE | H1 FOOD GRADE (FDA /USDA) |
| SEALS | NBR |
| SLINGER | SUS304 |
| ANTI-ROTATION PIN | SUS304 |
| SET SCREWS | SUS304 |
| CLEARANCE | C3 |
| AVAILABLE SIZES | UC201X ~ UC212 |

S7

PLATED INSERT



- | | |
|--------------------------|---|
| RINGS | SUJ2 + (zinc plated + trivalent chromate treatment) |
| BALLS | SUJ2 |
| CAGE | NYLON |
| GREASE | H1 FOOD GRADE (FDA /USDA) |
| SEALS | NBR |
| SLINGER | SPCC + (zinc plated + trivalent chromate treatment) |
| ANTI-ROTATION PIN | SUS304 |
| SET SCREWS | SCM435 + (zinc plated + trivalent chromate treatment) |
| CLEARANCE | C3 |
| AVAILABLE SIZES | 204 ~ 212 |



Great performance in demanding salt spray tests (72 hrs) on Stainless units



Solid base housings prevent debris from collecting underneath the unit.



Thermoplastic Housings



BODY	Thermoplastic Polyester
BOLT SLEEVE	SUS304
GREASE NIPPLE NUT	SUS304
AVAILABLE SIZES	204 ~ 208



Stainless Steel Housings



BODY	Lost wax casting (SUS304 or 316 equivalent)
BOLT SLEEVE	
GREASE NIPPLE NUT	
AVAILABLE SIZES	203 ~ 212 (depends on types)

Common Applications

- Food and Beverage Processing
- Chemical & Rubber Processing
- Packaging
- Car Washes



Nickel Plated Housings



BODY	Cast iron + Nickel Plating
BOLT SLEEVE	
GREASE NIPPLE NUT	
AVAILABLE SIZES	204 ~ 212





Stainless steel series pillow type units

UCSP-H1S6

Cylindrical bore (with set screws)

d 12 ~ 60 mm

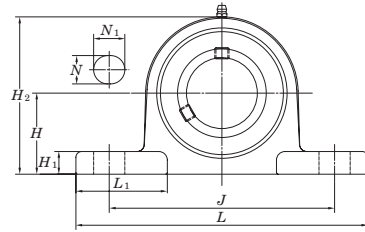
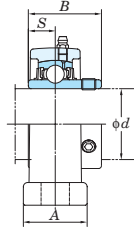

Shaft Dia. mm inch	Dimensions inch mm											Bolt Size inch mm	Unit No.	Housing No.	Bearing No.	Mass kg
	<i>d</i>	<i>H</i>	<i>L</i>	<i>A</i>	<i>J</i>	<i>N</i>	<i>N</i> ₁	<i>H</i> ₁	<i>H</i> ₂	<i>L</i> ₁	<i>B</i>					
12 1/2	1 3/16	5	1 3/16	3 3/4	1/2	23/32	7/16	2 7/32	1 21/32	1.079	0.453	3/8	UCSP201XH1S6 UCSP201-8XH1S6 UCSP202XH1S6 UCSP202-10XH1S6 UCSP203XH1S6	SP203H1	UC201XS6 UC201-8XS6 UC202XS6 UC202-10XS6 UC203XS6	0.47
15 5/8	30.2	127	30	95	13	18	11	56	42	27.4	11.5	M10				
17																
20 3/4	1 5/16	5	1 3/16	3 3/4	1/2	23/32	7/16	2 15/32	1 21/32	1.220	0.500	3/8	UCSP204-12H1S6 UCSP204H1S6	SP204H1	UC204-12S6 UC204S6	0.6
25 7/8	1 7/16	5 1/2	1 3/16	4 1/8	1/2	3/4	15/32	2 23/32	1 13/16	1.343	0.563	3/8				
25 15/16	36.5	140	30	105	13	19	12	69	46	34.1	14.3	M10				
30 1 1/8	1 11/16	6 1/2	1 13/32	4 3/4	21/32	13/16	1/2	3 3/16	2 1/8	1.500	0.626	1/2	UCSP206-18H1S6 UCSP206H1S6 UCSP206-19H1S6 UCSP206-20H1S6	SP206H1	UC206-18S6 UC206S6 UC206-19S6 UC206-20S6	1.1
30 1 3/16	42.9	165	36	121	17	21	13	81	54	38.1	15.9	M14				
30 1 1/4																
35 1 5/16	1 7/8	6 9/16	1 1/2	5	21/32	13/16	9/16	3 19/32	2	1.689	0.689	1/2	UCSP207-20H1S6 UCSP207-21H1S6 UCSP207-22H1S6 UCSP207H1S6 UCSP207-23H1S6	SP207H1	UC207-20S6 UC207-21S6 UC207-22S6 UC207S6 UC207-23S6	1.4
35 1 3/8	47.6	167	38	127	17	21	14	91	51	42.9	17.5	M14				
35 1 7/16																
40 1 1/2	1 15/16	7 1/4	1 9/16	5 13/32	21/32	13/16	9/16	3 13/16	2 3/8	1.937	0.748	1/2	UCSP208-24H1S6 UCSP208-25H1S6 UCSP208H1S6	SP208H1	UC208-24S6 UC208-25S6 UC208S6	1.7
40 1 9/16	49.2	184	40	137	17	21	14	97	60	49.2	19	M14				
40																
45 1 5/8	2 1/8	7 15/32	1 9/16	5 3/4	21/32	13/16	19/32	4 3/32	2 13/32	1.937	0.748	1/2	UCSP209-26H1S6 UCSP209-27H1S6 UCSP209-28H1S6 UCSP209H1S6	SP209H1	UC209-26S6 UC209-27S6 UC209-28S6 UC209S6	2
45 1 11/16	54	190	40	146	17	21	15	104	61	49.2	19	M14				
45 1 3/4																
50 1 7/8	2 1/4	8 1/8	1 25/32	6 1/4	25/32	7/8	5/8	4 3/8	2 9/16	2.031	0.748	5/8	UCSP210-30H1S6 UCSP210-31H1S6 UCSP210H1S6 UCSP210-32H1S6	SP210H1	UC210-30S6 UC210-31S6 UC210S6 UC210-32S6	2.5
50 1 15/16	57.2	206	45	159	20	22	16	111	65	51.6	19	M16				
50 2																
55 2	2 1/2	8 5/8	1 7/8	6 23/32	25/32	7/8	5/8	4 29/32	2 3/4	2.189	0.874	5/8	UCSP211-32H1S6 UCSP211-34H1S6 UCSP211H1S6 UCSP211-35H1S6	SP211H1	UC211-32S6 UC211-34S6 UC211S6 UC211-35S6	3.4
55 2 1/8	63.5	219	48	171	20	22	16	125	70	55.6	22.2	M16				
55 2 3/16																
60 2 1/4	2 3/4	9 1/2	2 5/32	7 1/4	25/32	31/32	7/8	5 7/16	3	2.563	1.000	5/8	UCSP212-36H1S6 UCSP212H1S6 UCSP212-38H1S6 UCSP212-39H1S6	SP212H1	UC212-36S6 UC212S6 UC212-38S6 UC212-39S6	4.5
60 2 3/8	69.8	241	55	184	20	25	17	138	76	65.1	25.4	M16				
60 2 7/16																

Part No. of the applicable grease fitting is shown below.

- A-1/4-28UNFN12 201X-210
- A-R1/8N12 211-212

Stainless steel series tapped-base pillow type units



UCSPA-H1S6

Cylindrical bore (with set screws)

d 12 ~ 40 mm

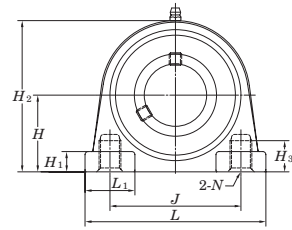
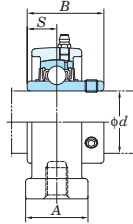

Shaft Dia. mm inch	Dimensions										Unit No.	Housing No.	Bearing No.	Mass
	inch mm													
<i>d</i>	<i>H</i>	<i>L</i>	<i>A</i>	<i>J</i>	<i>N</i>	<i>H</i> ₁	<i>H</i> ₂	<i>L</i> ₁	<i>B</i>	<i>S</i>				kg
12 1/2	1 3/16	3	1 3/16	2 3/64		13/32	2 1/4	7/8	1.079	0.453	UCSPA201XH1S6 UCSPA201-8XH1S6 UCSPA202XH1S6	SPA203H1	UC201XS6 UC201-8XS6 UC202XS6	0.43
	30.2	76	30	52	M10×1.5	10	57	22	27.4	11.5				
15 5/8	1 3/16	3	1 3/16	2 3/64		13/32	2 3/8	7/8	1.220	0.500	UCSPA204-12H1S6 UCSPA204H1S6	SPA204H1	UC204-12S6 UC204S6	0.47
	30.2	76	30	52	M10×1.5	10	60	22	31	12.7				
17	1 3/16	3	1 3/16	2 3/64		13/32	2 23/32	15/16	1.343	0.563	UCSPA205-16H1S6	SPA205H1	UC205-16S6	0.63
	36.5	84	30	56	M10×1.5	12	69	24	34.1	14.3				
20	3/4	3	1 3/16	2 3/64		13/32	3 3/16	1 3/32	1.500	0.626	UCSPA206-19H1S6 UCSPA206-20H1S6	SPA206H1	UC206-19S6 UC206-20S6	0.91
	30.2	76	30	52	M10×1.5	10	60	22	31	12.7				
25	7/8	3 5/16	1 3/16	2 13/64		15/32	3 19/32	1 3/16	1.689	0.689	UCSPA207-21H1S6 UCSPA207-22H1S6 UCSPA207H1S6 UCSPA207-23H1S6	SPA207H1	UC207-21S6 UC207-22S6 UC207S6 UC207-23S6	1.3
	36.5	84	30	56	M10×1.5	12	69	24	34.1	14.3				
30	1 1/8	3 11/16	1 13/32	2 19/32		15/32	3 3/16	1 3/32	1.500	0.626	UCSPA206-18H1S6 UCSPA206H1S6	SPA206H1	UC206-18S6 UC206S6	0.91
	42.9	94	36	66	M14×2	12	81	28	38.1	15.9				
35	1 1/4	3 11/16	1 13/32	2 19/32		15/32	3 3/16	1 3/32	1.500	0.626	UCSPA206-18H1S6 UCSPA206H1S6	SPA206H1	UC206-18S6 UC206S6	0.91
	42.9	94	36	66	M14×2	12	81	28	38.1	15.9				
40	1 1/2	4 9/16	1 9/16	3 5/16		1/2	3 13/16	1 1/4	1.937	0.748	UCSPA208-24H1S6 UCSPA208-25H1S6 UCSPA208H1S6	SPA208H1	UC208-24S6 UC208-25S6 UC208S6	1.6
	49.2	116	40	84	M14×2	13	97	32	49.2	19				

Part No. of the applicable grease fitting is A-1/4-28UNFN12.



Stainless steel series square four-bolt flange type units

UCSF-H1S6
Cylindrical bore (with set screws)
d 20 ~ 60 mm

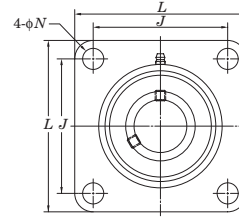
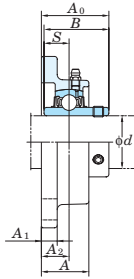

Shaft Dia. mm inch	Dimensions inch mm										Bolt Size inch mm	Unit No.	Housing No.	Bearing No.	Mass kg
	d	L	A	J	N	A ₁	A ₂	A ₀	B	S					
20 3/4	3 3/8 86	1 1/32 26	2 33/64 64	15/32 12	13/32 10	19/32 15	1 5/16 33.3	1.220 31	0.500 12.7	3/8 M10	UCSF204-12H1S6 UCSF204H1S6	SF204H1	UC204-12S6 UC204S6	0.66	
25 7/8 15/16 1	3 3/4 95	1 3/32 27.5	2 3/4 70	15/32 12	13/32 10	5/8 16	1 13/32 35.8	1.343 34.1	0.563 14.3	3/8 M10	UCSF205-14H1S6 UCSF205-15H1S6 UCSF205H1S6 UCSF205-16H1S6	SF205H1	UC205-14S6 UC205-15S6 UC205S6 UC205-16S6	0.85	
30 1 1/8 1 3/16 1 1/4	4 1/4 108	1 7/32 31	3 17/64 83	15/32 12	13/32 10	45/64 18	1 19/32 40.2	1.500 38.1	0.626 15.9	3/8 M10	UCSF206-18H1S6 UCSF206H1S6 UCSF206-19H1S6 UCSF206-20H1S6	SF206H1	UC206-18S6 UC206S6 UC206-19S6 UC206-20S6	1.2	
35 1 1/4 1 5/16 1 3/8 1 7/16	4 19/32 117	1 11/32 34	3 5/8 92	35/64 14	7/16 11	3/4 19	1 3/4 44.4	1.689 42.9	0.689 17.5	7/16 M12	UCSF207-20H1S6 UCSF207-21H1S6 UCSF207-22H1S6 UCSF207H1S6 UCSF207-23H1S6	SF207H1	UC207-20S6 UC207-21S6 UC207-22S6 UC207S6 UC207-23S6	1.5	
40 1 1/2 1 9/16	5 1/8 130	1 13/32 36	4 1/64 102	5/8 16	15/32 12	55/64 21	2 1/32 51.2	1.937 49.2	0.748 19	1/2 M14	UCSF208-24H1S6 UCSF208-25H1S6 UCSF208H1S6	SF208H1	UC208-24S6 UC208-25S6 UC208S6	2	
45 1 5/8 1 11/16 1 3/4	5 13/32 137	1 1/2 38	4 9/64 105	5/8 16	1/2 13	55/64 22	2 1/16 52.2	1.937 49.2	0.748 19	1/2 M14	UCSF209-26H1S6 UCSF209-27H1S6 UCSF209-28H1S6 UCSF209H1S6	SF209H1	UC209-26S6 UC209-27S6 UC209-28S6 UC209S6	2.3	
50 1 7/8 1 15/16 2 2	5 5/8 143	1 9/16 40	4 3/8 111	5/8 16	1/2 13	55/64 22	2 5/32 54.6	2.031 51.6	0.748 19	1/2 M14	UCSF210-30H1S6 UCSF210-31H1S6 UCSF210H1S6 UCSF210-32H1S6	SF210H1	UC210-30S6 UC210-31S6 UC210S6 UC210-32S6	2.6	
55 2 2 1/8 2 3/16	6 3/8 162	1 11/16 43	5 1/8 130	3/4 19	19/32 15	63/64 25	2 5/16 58.4	2.189 55.6	0.874 22.2	5/8 M16	UCSF211-32H1S6 UCSF211-34H1S6 UCSF211H1S6 UCSF211-35H1S6	SF211H1	UC211-32S6 UC211-34S6 UC211S6 UC211-35S6	4	
60 2 1/4 2 3/8 2 7/16	6 7/8 175	1 7/8 48	5 5/8 143	3/4 19	19/32 15	1 9/64 29	2 23/32 68.7	2.563 65.1	1.000 25.4	5/8 M16	UCSF212-36H1S6 UCSF212H1S6 UCSF212-38H1S6 UCSF212-39H1S6	SF212H1	UC212-36S6 UC212S6 UC212-38S6 UC212-39S6	4.7	

Part No. of the applicable grease fitting is are shown below.
A-1/4-28UNFN12 204~210
A-R1/8N12 211~212



Stainless steel series square four-bolt flange type units

UCSF-EH1S6
Cylindrical bore (with set screws)
d 20 ~ 60 mm

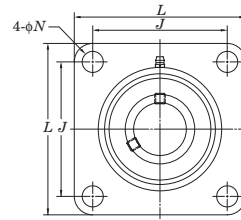
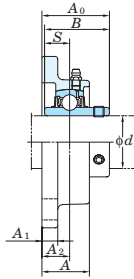

Shaft Dia. mm inch	Dimensions inch mm										Bolt Size inch	Unit No.	Housing No.	Bearing No.	Mass kg
	L	A	J	N	A ₁	A ₂	A ₀	B	S	d					
20 3/4	3 3/8 86	1 1/32 26	2 33/64 64	7/16 11	19/32 10	19/32 15	1 5/16 33.3	1.220 31	0.500 12.7	3/8	UCSF204-12EH1S6 UCSF204EH1S6	SF204EH1	UC204-12S6 UC204S6	0.66	
25 7/8 15/16 1	Please refer to the UCSF-H1S6.														
30 1 1/8 1 3/16 1 1/4	4 1/4 108	1 7/32 31	3 17/64 83	33/64 13	19/32 10	45/64 18	1 19/32 40.2	1.500 38.1	0.626 15.9	7/16	UCSF206-18EH1S6 UCSF206EH1S6 UCSF206-19EH1S6 UCSF206-20EH1S6	SF206EH1	UC206-18S6 UC206S6 UC206-19S6 UC206-20S6	1.2	
35 1 1/4 1 5/16 1 3/8 1 7/16	4 19/32 117	1 11/32 34	3 5/8 92	33/64 13	7/16 11	3/4 19	1 3/4 44.4	1.689 42.9	0.689 17.5	7/16	UCSF207-20EH1S6 UCSF207-21EH1S6 UCSF207-22EH1S6 UCSF207EH1S6 UCSF207-23EH1S6	SF207EH1	UC207-20S6 UC207-21S6 UC207-22S6 UC207S6 UC207-23S6	1.5	
40 1 1/2 1 9/16	5 1/8 130	1 13/32 36	4 1/64 102	35/64 14	15/32 12	53/64 21	2 1/32 51.2	1.937 49.2	0.748 19	1/2	UCSF208-24EH1S6 UCSF208-25EH1S6 UCSF208EH1S6	SF208EH1	UC208-24S6 UC208-25S6 UC208S6	2	
45 1 5/8 1 11/16 1 3/4	Please refer to the UCSF-H1S6.														
50 1 7/8 1 15/16 2	Please refer to the UCSF-H1S6.														
55 2 2 1/8 2 3/16	6 3/8 162	1 11/16 43	5 1/8 130	43/64 17	19/32 15	63/64 25	2 5/16 58.4	2.189 55.6	0.874 22.2	5/8	UCSF211-32EH1S6 UCSF211-34EH1S6 UCSF211EH1S6 UCSF211-35EH1S6	SF211EH1	UC211-32S6 UC211-34S6 UC211S6 UC211-35S6	4	
60 2 1/4 2 3/8 2 7/16	6 7/8 175	1 7/8 48	5 5/8 143	49/64 17	19/32 15	1 9/64 29	2 23/32 68.7	2.563 65.1	1.000 25.4	5/8	UCSF212-36EH1S6 UCSF212EH1S6 UCSF212-38EH1S6 UCSF212-39EH1S6	SF212EH1	UC212-36S6 UC212S6 UC212-38S6 UC212-39S6	4.7	

Part No. of the applicable grease fitting is are shown below.
A-1/4-28UNFN12 204-208
A-R1/8N12 211-212



Stainless steel series oval two-bolt flange type units

UCSFL-H1S6

Cylindrical bore (with set screws)

d 12 ~ 50 mm

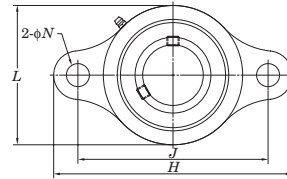
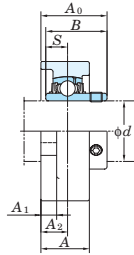

Shaft Dia. mm inch	Dimensions											Bolt Size inch mm	Unit No.	Housing No.	Bearing No.	Mass kg		
	<i>d</i>	<i>H</i>	<i>L</i>	<i>A</i>	<i>J</i>	<i>N</i>	<i>A</i> ₁	<i>A</i> ₂	<i>A</i> ₀	<i>B</i>	<i>S</i>						inch	mm
12 1/2																		
15 5/8	1 27/32 98	2 1/16 52	1 19/16 24	3 76.5	15/32 12	13/32 10	9/16 14	2 3/16 29.9	1.079 27.4	0.453 11.5	3/8 M10	UCSFL201XSH1S6 UCSFL201-8XSH1S6 UCSFL202XSH1S6 UCSFL202-10XSH1S6 UCSFL203XSH1S6	SFL203H1	UC201XS6 UC201-8XS6 UC202XS6 UC202-10XS6 UC203XS6	0.33			
17																		
20 3/4	4 7/16 113	2 3/8 60	1 1/32 26	3 35/64 90	15/32 12	13/32 10	19/32 15	1 5/16 33.3	1.220 31	0.500 12.7	3/8 M10	UCSFL204-12H1S6 UCSFL204H1S6	SFL204H1	UC204-12S6 UC204S6	0.47			
25 7/8 15/16 1	5 1/8 130	2 11/16 68	1 3/32 27.5	3 57/64 99	5/8 16	13/32 10	5/8 16	1 13/32 34.1	1.343 34.1	0.563 14.3	1/2 M14	UCSFL205-14H1S6 UCSFL205-15H1S6 UCSFL205H1S6 UCSFL205-16H1S6	SFL205H1	UC205-14S6 UC205-15S6 UC205S6 UC205-16S6	0.61			
30 1 1/8 1 3/16 1 1/4	5 13/16 148	3 5/32 80	1 7/32 31	4 19/32 117	5/8 16	13/32 10	45/64 18	1 19/32 40.2	1.500 38.1	0.626 15.9	1/2 M14	UCSFL206-18H1S6 UCSFL206H1S6 UCSFL206-19H1S6 UCSFL206-20H1S6	SFL206H1	UC206-18S6 UC206S6 UC206-19S6 UC206-20S6	0.9			
35 1 1/4 1 5/16 1 3/8 1 7/16	6 11/32 161	3 11/32 85	1 11/32 34	5 1/8 130	5/8 16	7/16 11	3/4 19	1 3/4 44.4	1.689 42.9	0.689 17.5	1/2 M14	UCSFL207-20H1S6 UCSFL207-21H1S6 UCSFL207-22H1S6 UCSFL207H1S6 UCSFL207-23H1S6	SFL207H1	UC207-20S6 UC207-21S6 UC207-22S6 UC207S6 UC207-23S6	1.1			
40 1 1/2 1 9/16	6 7/8 175	3 11/16 94	1 13/32 36	5 49/64 144	5/8 16	15/32 12	59/64 21	2 1/32 51.2	1.937 49.2	0.748 19	1/2 M14	UCSFL208-24H1S6 UCSFL208-25H1S6 UCSFL208H1S6	SFL208H1	UC208-24S6 UC208-25S6 UC208S6	1.4			
45 1 5/8 1 11/16 1 3/4	7 13/32 188	3 15/16 100	1 1/2 38	5 59/64 148	3/4 19	1/2 13	59/64 22	2 1/16 52.2	1.937 49.2	0.748 19	5/8 M16	UCSFL209-26H1S6 UCSFL209-27H1S6 UCSFL209-28H1S6 UCSFL209H1S6	SFL209H1	UC209-26S6 UC209-27S6 UC209-28S6 UC209S6	1.6			
50 1 7/8 1 15/16 2	7 3/4 197	4 3/16 106	1 9/16 40	6 3/16 157	3/4 19	1/2 13	59/64 22	2 5/32 54.6	2.031 51.6	0.748 19	5/8 M16	UCSFL210-30H1S6 UCSFL210-31H1S6 UCSFL210H1S6 UCSFL210-32H1S6	SFL210H1	UC210-30S6 UC210-31S6 UC210S6 UC210-32S6	1.9			

Part No. of the applicable grease fitting is A-1/4-28UNFN12.

Stainless steel series oval two-bolt flange type units

UCSFL-EH1S6

Cylindrical bore (with set screws)

d 12 ~ 50 mm

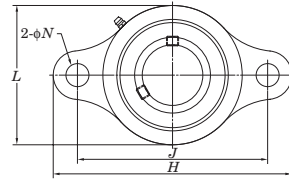
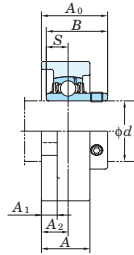

Shaft Dia. mm inch	Dimensions											Bolt Size inch mm	Unit No.	Housing No.	Bearing No.	Mass kg
	<i>d</i>	<i>H</i>	<i>L</i>	<i>A</i>	<i>J</i>	<i>N</i>	<i>A</i> ₁	<i>A</i> ₂	<i>A</i> ₀	<i>B</i>	<i>S</i>					
12 1/2	1 27/32	2 1/16	1 15/16	3	25/64	13/32	9/16	2 3/16	1.079	0.453	5/16	UCSFL201XESH1S6 UCSFL201-8XESH1S6 UCSFL202XESH1S6 UCSFL202-10XESH1S6 UCSFL203XESH1S6	SFL203EH1	UC201XS6 UC201-8XS6 UC202XS6 UC202-10XS6 UC203XS6	0.33	
15 5/8	98	52	24	76.2	10	10	14	29.9	27.4	11.5	5/16	UCSFL204-12EH1S6 UCSFL204EH1S6	SFL204EH1	UC204-12S6 UC204S6	0.47	
20 3/4	4 7/16	2 3/8	1 1/32	3 17/32	25/64	13/32	19/32	1 5/16	1.220	0.500	5/16	UCSFL205-14EH1S6 UCSFL205-15EH1S6 UCSFL205EH1S6 UCSFL205-16EH1S6	SFL205EH1	UC205-14S6 UC205-15S6 UC205S6 UC205-16S6	0.61	
25 1 7/8	5 1/8	2 11/16	1 3/32	3 57/64	15/32	13/32	5/8	1 13/32	1.343	0.563	3/8	UCSFL206-18EH1S6 UCSFL206EH1S6 UCSFL206-19EH1S6 UCSFL206-20EH1S6	SFL206EH1	UC206-18S6 UC206S6 UC206-19S6 UC206-20S6	0.9	
30 1 3/16	5 13/16	3 5/32	1 7/32	4 19/32	15/32	13/32	45/64	1 19/32	1.500	0.626	3/8	UCSFL207-20EH1S6 UCSFL207-21EH1S6 UCSFL207-22EH1S6 UCSFL207EH1S6 UCSFL207-23EH1S6	SFL207EH1	UC207-20S6 UC207-21S6 UC207-22S6 UC207S6 UC207-23S6	1.1	
35 1 1/4	6 11/32	3 11/32	1 11/32	5 1/8	33/64	7/16	3/4	1 3/4	1.689	0.689	7/16	UCSFL208-24EH1S6 UCSFL208-25EH1S6 UCSFL208EH1S6	SFL208EH1	UC208-24S6 UC208-25S6 UC208S6	1.4	
40 1 9/16	6 7/8	3 11/16	1 13/32	5 21/32	33/64	15/32	53/64	2 1/32	1.937	0.748	7/16	UCSFL209-26EH1S6 UCSFL209-27EH1S6 UCSFL209-28EH1S6 UCSFL209EH1S6	SFL209EH1	UC209-26S6 UC209-27S6 UC209-28S6 UC209S6	1.6	
45 1 5/8	7 13/32	3 15/16	1 1/2	5 27/32	19/32	1/2	55/64	2 1/16	1.937	0.748	1/2	UCSFL210-30EH1S6 UCSFL210-31EH1S6 UCSFL210EH1S6 UCSFL210-32EH1S6	SFL210EH1	UC210-30S6 UC210-31S6 UC210S6 UC210-32S6	1.9	
50 1 15/16	7 3/4	4 3/16	1 9/16	6 3/16	19/32	1/2	55/64	2 5/32	2.031	0.748	1/2	UCSFL210-30EH1S6 UCSFL210-31EH1S6 UCSFL210EH1S6 UCSFL210-32EH1S6	SFL210EH1	UC210-30S6 UC210-31S6 UC210S6 UC210-32S6	1.9	

Part No. of the applicable grease fitting is A-1/4-28UNFN12.



Stainless steel series take-up type units

UCST-H1S6

Cylindrical bore (with set screws)

d 20 ~ 50 mm

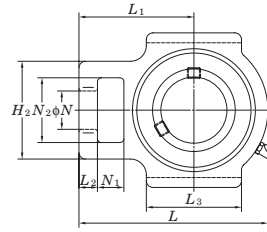
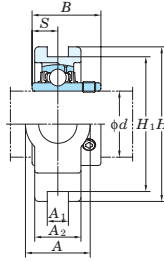

Shaft Dia. mm inch	Dimensions															Unit No.	Housing No.	Bearing No.	Mass			
	inch mm																					
<i>d</i>	A	A ₁	A ₂	H	H ₁	H ₂	L	L ₁	L ₂	L ₃	N	N ₁	N ₂	B	S				kg			
20	3/4	1 1/4	15/32	29/32	3 1/2	3	1 13/16	3 1/2	2 5/16	11/32	1 23/32	3/4	23/32	1 1/4	1.220	0.500	UCST204-12H1S6	ST204H1	UC204-12S6	0.73		
		32	12	23	89	76.2	46	89	59	9	44	19	18	32	31	12.7	UCST204H1S6		UC204S6			
25	7/8	15/16	1 1/4	15/32	31/32	3 1/2	3	1 13/16	3 21/32	2 3/8	11/32	1 23/32	3/4	23/32	1 1/4	1.343	0.563	UCST205-14H1S6	ST205H1	UC205-14S6	0.79	
			32	12	25	89	76.2	46	93	60	9	44	19	18	32	34.1	14.3	UCST205-15H1S6		UC205-15S6		
30	1 1/8	1 3/16	1 15/32	15/32	1 1/16	4 1/32	3 1/2	2 1/16	4 3/16	2 5/8	11/32	1 31/32	7/8	23/32	1 15/32	1.500	0.626	UCST205-16H1S6	ST206H1	UC205-16S6	1.1	
			37	12	27	102	88.9	52	106	67	9	50	22	18	37	38.1	15.9	UCST206-18H1S6		UC206-18S6		
35	1 1/4	1 5/16	1 3/8	1 15/32	15/32	1 7/32	4 1/32	3 1/2	2 7/32	4 11/16	2 15/16	7/16	2 7/32	7/8	23/32	1 15/32	1.689	0.689	UCST206-19H1S6	ST207H1	UC206-19S6	1.5
				37	12	31	102	88.9	56	119	75	11	56	22	18	37	42.9	17.5	UCST207-20H1S6		UC207-20S6	
40	1 1/2	1 9/16	1 15/16	5/8	1 1/4	4 1/2	4	2 29/32	5 5/16	3 11/32	9/16	2 17/32	1 5/32	25/32	1 15/16	1.937	0.748	UCST207-21H1S6	ST208H1	UC207-21S6	2.0	
			49	16	32	114	101.6	74	135	85	14	64	29	20	49	49.2	19	UCST207-22H1S6		UC207-22S6		
45	1 5/8	1 11/16	1 3/4	1 15/16	5/8	1 11/32	4 19/32	4	2 29/32	5 13/32	3 11/32	9/16	2 19/32	1 5/32	25/32	1 15/16	1.937	0.748	UCST208-24H1S6	ST209H1	UC208-24S6	2.1
				49	16	34	117	101.6	74	137	85	14	66	29	20	49	49.2	19	UCST209-26H1S6		UC209-26S6	
50	1 7/8	1 15/16	2	1 15/16	5/8	1 3/8	4 19/32	4	2 29/32	5 5/8	3 7/16	9/16	2 27/32	1 5/32	25/32	1 15/16	2.031	0.748	UCST209-27H1S6	ST210H1	UC209-27S6	2.3
				49	16	35	117	101.6	74	143	87	14	72	29	20	49	51.6	19	UCST209-28H1S6		UC209-28S6	
																	UCST210-30H1S6		UC210-30S6			
																		UCST210-31H1S6		UC210-31S6		
																		UCST210H1S6		UC210S6		
																		UCST210-32H1S6		UC210-32S6		

Part No. of the applicable grease fitting is B-1/4-28UNFN12.



Stainless steel series take-up type units

UCST-EH1S6

Cylindrical bore (with set screws)

d 20 ~ 50 mm

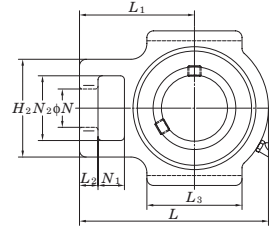
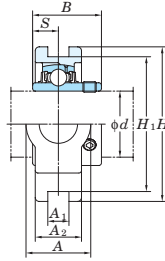

Shaft Dia.		Dimensions															Unit No.	Housing No.	Bearing No.	Mass
mm	inch	inch mm																		
d		A	A ₁	A ₂	H	H ₁	H ₂	L	L ₁	L ₂	L ₃	N	N ₁	N ₂	B	S				kg
20	3/4	1 1/4	17/32	29/32	3 1/2	3	1 13/16	3 1/2	2 5/16	1 11/32	1 23/32	3/4	23/32	1 1/4	1.220	0.500	UCST204-12EH1S6	ST204EH1	UC204-12S6 UC204S6	0.73
			32	13.5	23	89	76.2	46	89	59	9	44	19	18	32	31	12.7			
25	7/8	1 1/4	17/32	31/32	3 1/2	3	1 13/16	3 21/32	2 3/8	1 11/32	1 23/32	3/4	23/32	1 1/4	1.343	0.563	UCST205-14EH1S6	ST205EH1	UC205-14S6 UC205-15S6 UC205S6	0.79
		15/16	32	13.5	25	89	76.2	46	93	60	9	44	19	18	32	34.1	14.3			
30	1 1/8	1 15/32	17/32	1 1/16	4 1/32	3 1/2	2 1/16	4 3/16	2 5/8	1 11/32	1 31/32	7/8	23/32	1 15/32	1.500	0.626	UCST206-18EH1S6	ST206EH1	UC206-18S6 UC206S6	1.1
		1 3/16	37	13.5	27	102	88.9	52	106	67	9	50	22	18	37	38.1	15.9			
35	1 1/4	1 15/32	17/32	1 7/32	4 1/32	3 1/2	2 7/32	4 11/16	2 15/16	7/16	2 7/32	7/8	23/32	1 15/32	1.689	0.689	UCST207-20EH1S6	ST207EH1	UC207-20S6 UC207-21S6 UC207-22S6 UC207S6	1.5
		1 5/16	37	13.5	31	102	88.9	56	119	75	11	56	22	18	37	42.9	17.5			
40	1 1/2	1 15/16	11/16	1 1/4	4 1/2	4	2 29/32	5 5/16	3 11/32	9/16	2 17/32	1 5/32	25/32	1 15/16	1.937	0.748	UCST208-24EH1S6	ST208EH1	UC208-24S6 UC208-25S6 UC208S6	2.0
		1 9/16	49	17.5	32	114	101.6	74	135	85	14	64	29	20	49	49.2	19			
45	1 5/8	1 15/16	11/16	1 11/32	4 19/32	4	2 29/32	5 13/32	3 11/32	9/16	2 19/32	1 5/32	25/32	1 15/16	1.937	0.748	UCST209-26EH1S6	ST209EH1	UC209-26S6 UC209-27S6 UC209-28S6 UC209S6	2.1
		1 11/16	49	17.5	34	117	101.6	74	137	85	14	66	29	20	49	49.2	19			
50	1 7/8	1 15/16	11/16	1 3/8	4 19/32	4	2 29/32	5 5/8	3 7/16	9/16	2 27/32	1 5/32	25/32	1 15/16	2.031	0.748	UCST210-30EH1S6	ST210EH1	UC210-30S6 UC210-31S6 UC210S6	2.3
		1 15/16	49	17.5	35	117	101.6	74	143	87	14	72	29	20	49	51.6	19			

Part No. of the applicable grease fitting is B-1/4-28UNFN12.



Plastic series pillow type units

UCVP-ES7

Cylindrical bore (with set screws)

d 20 ~ 50 mm

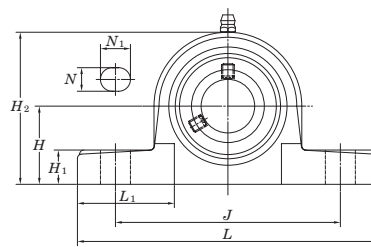
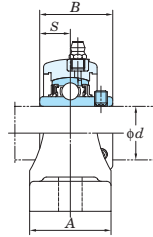

Shaft Dia. mm inch	Dimensions											Bolt Size inch mm	Unit No.	Housing No.	Bearing No.	Mass kg
	<i>d</i>	<i>H</i>	<i>L</i>	<i>A</i>	<i>J</i>	<i>N</i>	<i>N</i> ₁	<i>H</i> ₁	<i>H</i> ₂	<i>B</i>	<i>S</i>					
20 ^{3/4}	1 5/16	5	1 1/2	3 3/4	7/16	9/16	9/16	2 19/32	1.220	0.500	3/8	UCVP204-12ES7	VP204E	UC204-12S7 UC204S7	0.29	
	33.3	127	38	95	11	14	14.2	65.5	31	12.7	M10	UCVP204ES7				
25 ^{7/8} ^{15/16}	1 7/16	5 17/32	1 1/2	4 1/8	7/16	9/16	5/8	2 25/32	1.343	0.563	3/8	UCVP205-14ES7	VP205E	UC205-14S7 UC205-15S7 UC205S7 UC205-16S7	0.41	
	36.5	140.5	38	105	11	14	16	71	34.1	14.3	M10	UCVP205ES7 UCVP205-16ES7				
30 ^{1 1/8} ^{1 3/16} ^{1 1/4}	1 11/16	6 13/32	1 13/16	4 11/16	9/16	23/32	11/16	3 5/16	1.500	0.626	1/2	UCVP206-18ES7	VP206E	UC206-18S7 UC206S7 UC206-19S7 UC206-20S7	0.6	
	42.9	163	46	119	14	18	17.8	84	38.1	15.9	M12	UCVP206ES7 UCVP206-19ES7 UCVP206-20ES7				
35 ^{1 1/4} ^{1 5/16} ^{1 3/8} ^{1 7/16}	1 7/8	6 5/8	1 7/8	5	9/16	23/32	23/32	3 23/32	1.689	0.689	1/2	UCVP207-20ES7	VP207E	UC207-20S7 UC207-21S7 UC207-22S7 UC207S7 UC207-23S7	0.84	
	47.6	168	48	127	14	18	18	94.5	42.9	17.5	M12	UCVP207-21ES7 UCVP207-22ES7 UCVP207ES7 UCVP207-23ES7				
40 ^{1 1/2} ^{1 9/16}	1 15/16	7 1/4	2 1/8	5 13/32	9/16	23/32	25/32	3 31/32	1.937	0.748	1/2	UCVP208-24ES7	VP208E	UC208-24S7 UC208-25S7 UC208S7	1.1	
	49.2	184	54	137	14	18	19.5	101	49.2	19	M12	UCVP208-25ES7 UCVP208ES7				
45 ^{1 5/8} ^{1 11/16} ^{1 3/4}	2 1/8	7 9/16	2 1/8	5 3/4	21/32	25/32	29/32	4 3/16	1.937	0.748	5/8	UCVP209-26ES7	VP209E	UC209-26S7 UC209-27S7 UC209-28S7 UC209S7	1.2	
	54	192	54	146	17	20	23	106	49.2	19	M14	UCVP209-27ES7 UCVP209-28ES7 UCVP209ES7				
50 ^{1 7/8} ^{1 15/16} ²	2 1/4	8 1/8	2 3/8	6 1/4	21/32	25/32	29/32	4 1/2	2.031	0.748	5/8	UCVP210-30ES7	VP210E	UC210-30S7 UC210-31S7 UC210S7 UC210-32S7	1.4	
	57.2	206	60	159	17	20	23	114	51.6	19	M14	UCVP210-31ES7 UCVP210ES7 UCVP210-32ES7				

Part No. of the applicable grease fitting is A-1/4-28UNFN12.



Plastic series pillow type units

UCVPAN-ES7
Cylindrical bore (with set screws)
d 20 ~ 35 mm

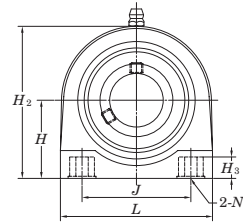
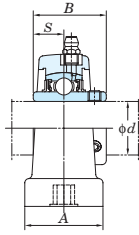

Shaft Dia		Dimensions										Unit No.	Housing No.	Bearing No.	Mass
mm	inch	inch mm													
d		H	L	A	J	N	H ₂	H ₃	B	S					
20	3/4	1 5/16	2 7/8	1 11/32	2	3/8-16UNC	2 19/32	13/32	1.220	0.500	UCVPAN204-12ES7 UCVPAN204ES7	VPAN204E	UC204-12S7 UC204S7	0.26	
			33.3	73	34.5	50.8		66	10.5	31					12.7
25	7/8	1 7/16	2 25/32	1 7/16	2	3/8-16UNC	2 25/32	13/32	1.343	0.563	UCVPAN205-14ES7 UCVPAN205-15ES7 UCVPAN205ES7 UCVPAN205-16ES7	VPAN205E	UC205-14S7 UC205-15S7 UC205S7 UC205-16S7	0.36	
		15/16	36.5	71	36.5	50.8		71	10.5	34.1					14.3
30	1 1/8	1 11/16	4	1 11/16	3	7/16-14UNC	3 5/16	15/32	1.500	0.626	UCVPAN206-18ES7 UCVPAN206ES7 UCVPAN206-19ES7 UCVPAN206-20ES7	VPAN206E	UC206-18S7 UC206S7 UC206-19S7 UC206-20S7	0.54	
		1 3/16	42.9	101.6	42.5	76.2		84	12.1	38.1					15.9
35	1 1/4	1 7/8	4 11/32	1 7/8	3 1/4	1/2-13UNC	3 3/4	17/32	1.689	0.689	UCVPAN207-20ES7 UCVPAN207-21ES7 UCVPAN207-22ES7 UCVPAN207ES7 UCVPAN207-23ES7	VPAN207E	UC207-20S7 UC207-21S7 UC207-22S7 UC207S7 UC207-23S7	0.84	
		1 5/16	47.6	110	48	82.6		95	13.7	42.9					17.5
	1 3/8														
	1 7/16														

Part No. of the applicable grease fitting is A-1/4-28UNFN12.

Plastic series square four-bolt flange type units

UCVF-ES7
Cylindrical bore (with set screws)
d 20 ~ 40 mm

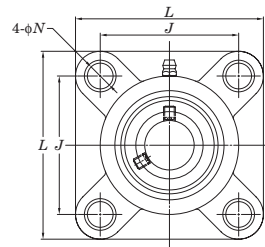
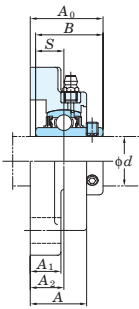

Shaft Dia.		Dimensions										Bolt Size	Unit No.	Housing No.	Bearing No.	Mass
mm	inch	inch mm														
d		L	A	J	N	A ₁	A ₂	A ₀	B	S						
20	3/4	3 3/8	1 3/32	2 1/2	7/16	17/32	45/64	1 7/16	1.220	0.500	3/8 M8	UCVF204-12ES7 UCVF204ES7	VF204E	UC204-12S7 UC204S7	0.3	
			86	27.8	63.5	11	13.4	18	36.3	31						12.7
25	7/8	3 3/4	1 1/8	2 3/4	39/64	5/8	43/64	1 7/16	1.343	0.563	7/16 M10	UCVF205-14ES7 UCVF205-15ES7 UCVF205ES7 UCVF205-16ES7	VF205E	UC205-14S7 UC205-15S7 UC205S7 UC205-16S7	0.41	
		15/16	95	28.5	70	13	15.5	17	36.8	34.1						14.3
30	1 1/8	4 7/32	1 1/4	3 17/64	39/64	9/16	3/4	1 5/8	1.500	0.626	7/16 M10	UCVF206-18ES7 UCVF206ES7 UCVF206-19ES7 UCVF206-20ES7	VF206E	UC206-18S7 UC206S7 UC206-19S7 UC206-20S7	0.56	
		1 3/16	107	31.7	83	13	14.5	19.2	41.4	38.1						15.9
35	1 1/4	4 21/32	1 11/32	3 5/8	39/64	5/8	27/32	1 27/32	1.689	0.689	1/2 M12	UCVF207-20ES7 UCVF207-21ES7 UCVF207-22ES7 UCVF207ES7 UCVF207-23ES7	VF207E	UC207-20S7 UC207-21S7 UC207-22S7 UC207S7 UC207-23S7	0.83	
		1 5/16	118	34.5	92	14	15.5	21.5	46.9	42.9						17.5
40	1 1/2	5 1/8	1 7/16	4 1/64	39/64	21/32	29/32	2 3/32	1.937	0.748	1/2 M12	UCVF208-24ES7 UCVF208-25ES7 UCVF208ES7	VF208E	UC208-24S7 UC208-25S7 UC208S7	1.08	
		1 9/16	130	36.5	102	14	17	23	53.2	49.2						19

Part No. of the applicable grease fitting is A-1/4-28UNFN12.



Plastic series oval two-bolt flange type units

UCVFL-ES7
Cylindrical bore (with set screws)
d 20 ~ 40 mm

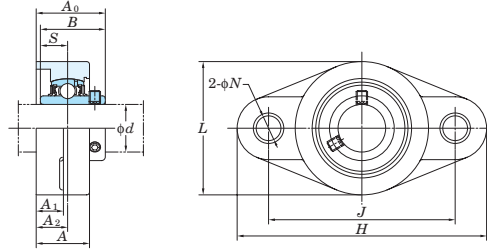

Shaft Dia. mm inch	Dimensions inch mm											Bolt Size inch mm	Unit No.	Housing No.	Bearing No.	Mass kg
	<i>d</i>	<i>H</i>	<i>L</i>	<i>A</i>	<i>J</i>	<i>N</i>	<i>A</i> ₁	<i>A</i> ₂	<i>A</i> ₀	<i>B</i>	<i>S</i>					
20	3/4	4 7/16	2 9/16	1 1/32	3 35/64	7/16	17/32	19/32	1 5/16	1.220	0.500	3/8	UCVFL204-12ES7 UCVFL204ES7	VFL204E	UC204-12S7 UC204S7	0.25
	113	65	26.5	90	11	13.4	15	33.3	31	12.7	M8					
25	7/8	5 5/32	2 3/4	1 3/32	3 57/64	33/64	17/32	5/8	1 13/32	1.343	0.563	7/16	UCVFL205-14ES7 UCVFL205-15ES7 UCVFL205ES7 UCVFL205-16ES7	VFL205E	UC205-14S7 UC205-15S7 UC205S7 UC205-16S7	0.35
	159/16	131	70	27.5	99	13	13.8	16	35.8	34.1	14.3	M10				
30	1 1/8	5 13/16	3 5/32	1 3/16	4 39/64	33/64	9/16	45/64	1 19/32	1.500	0.626	7/16	UCVFL206-18ES7 UCVFL206ES7 UCVFL206-19ES7 UCVFL206-20ES7	VFL206E	UC206-18S7 UC206S7 UC206-19S7 UC206-20S7	0.49
	1 3/16	148	80	30.5	117	13	14.3	18	40.2	38.1	15.9	M10				
35	1 1/4	6 15/32	3 17/32	1 1/4	5 1/8	35/64	5/8	3/4	1 3/4	1.689	0.689	1/2	UCVFL207-20ES7 UCVFL207-21ES7 UCVFL207-22ES7 UCVFL207ES7 UCVFL207-23ES7	VFL207E	UC207-20S7 UC207-21S7 UC207-22S7 UC207S7 UC207-23S7	0.73
	1 5/16	164	90	32	130	14	15.5	19	44.4	42.9	17.5	M12				
40	1 1/2	6 15/16	3 15/16	1 11/32	5 43/64	35/64	21/32	53/64	2 1/32	1.937	0.748	1/2	UCVFL208-24ES7 UCVFL208-25ES7 UCVFL208ES7	VFL208E	UC208-24S7 UC208-25S7 UC208S7	0.92
	1 9/16	176	100	34.5	144	14	16.5	21	51.2	49.2	19	M12				

Part No. of the applicable grease fitting is A-1/4-28UNFN12.

Plastic series three-bolt flange type units

UCVFB-ES7
Cylindrical bore (with set screws)
d 20 ~ 35 mm

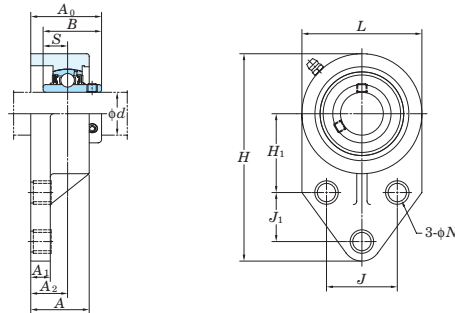

Shaft Dia. mm inch	Dimensions inch mm												Bolt Size inch mm	Unit No.	Housing No.	Bearing No.	Mass kg	
	<i>d</i>	<i>H</i>	<i>L</i>	<i>A</i>	<i>J</i>	<i>J</i> ₁	<i>N</i>	<i>H</i> ₁	<i>A</i> ₁	<i>A</i> ₂	<i>A</i> ₀	<i>B</i>						<i>S</i>
20	3/4	4 1/4	2 1/2	1	1 1/2	7/8	27/64	1 11/16	7/16	39/64	1 5/16	1.220	0.500	3/8	UCVFB204-12ES7 UCVFB204ES7	VFB204E	UC204-12S7 UC204S7	0.25
	108	63.5	25.4	38.1	22.2	10.7	42.9	11.4	15.4	33.7	31	12.7	M10					
25	7/8	4 3/4	2 3/4	1 11/32	1 5/8	1 1/8	27/64	1 13/16	7/16	27/32	1 5/8	1.343	0.563	3/8	UCVFB205-14ES7 UCVFB205-15ES7 UCVFB205ES7 UCVFB205-16ES7	VFB205E	UC205-14S7 UC205-15S7 UC205S7 UC205-16S7	0.31
	159/16	121	70	34.1	41.3	28.6	10.7	46	11.4	21.5	41.3	34.1	14.3	M10				
30	1 1/8	5 15/32	3 1/4	1 1/4	1 7/8	1 1/4	27/64	2 1/16	17/32	49/64	1 5/8	1.500	0.626	3/8	UCVFB206-18ES7 UCVFB206ES7 UCVFB206-19ES7 UCVFB206-20ES7	VFB206E	UC206-18S7 UC206S7 UC206-19S7 UC206-20S7	0.47
	1 3/16	139	83	32	47.6	31.8	10.7	52.4	13.3	19.3	41.5	38.1	15.9	M10				
35	1 1/4	6 3/16	3 3/4	1 7/16	2	1 1/4	17/32	2 3/8	5/8	27/32	1 27/32	1.689	0.689	1/2	UCVFB207-20ES7 UCVFB207-21ES7 UCVFB207-22ES7 UCVFB207ES7 UCVFB207-23ES7	VFB207E	UC207-20S7 UC207-21S7 UC207-22S7 UC207S7 UC207-23S7	0.66
	1 5/16	157	95	36.6	50.8	31.8	13.1	60.3	16.1	21.7	47.1	42.9	17.5	M12				

14 Part No. of the applicable grease fitting is A-1/4-28UNFN12.

Ball bearing inserts

UC-S6 and S7
Cylindrical bore (with set screws)
d 12 ~ 60 mm



UC-S6



UC-S7

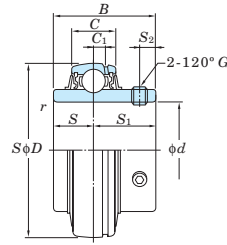

Shaft Dia.		Dimensions				Bearing No.		Dimensions				Set Screw	Mass
<i>d</i>		inch mm				Stainless	Plated	inch mm				Brg. Bore <i>G</i>	kg
mm	inch	<i>D</i>	<i>B</i>	<i>C</i>	<i>r</i> (min.)			<i>C</i> ₁	<i>S</i>	<i>S</i> ₁	<i>S</i> ₂	mm	
12	1/2	1.575	1.079	0.512	0.024	UC201XS6	–	0.138	0.453	0.626	0.158	M5×0.5	0.10
		40	27.4	13	0.6	UC201-8XS6	–	3.5	11.5	15.9	4		
15	5/8	1.575	1.079	0.512	0.024	UC202XS6	–	0.138	0.453	0.626	0.158	M5×0.5	0.10
		40	27.4	13	0.6	UC202-10XS6	–	3.5	11.5	15.9	4		
17	–	1.575	1.079	0.512	0.024	UC203XS6	–	0.138	0.453	0.626	0.158	M5×0.5	0.10
		40	27.4	13	0.6			3.5	11.5	15.9	4		
20	3/4	1.850	1.220	0.630	0.039	UC204-12S6	UC204-12S7	0.157	0.500	0.720	0.197	M6×0.75	0.16
		47	31	16	1	UC204S6	UC204S7	4	12.7	18.3	5		
25	7/8	2.047	1.343	0.669	0.039	UC205-14S6	UC205-14S7	0.197	0.563	0.780	0.217	M6×0.75	0.23
						UC205-15S6	UC205-15S7						
						UC205S6	UC205S7						
						UC205-16S6	UC205-16S7						
30	1 1/8	2.441	1.500	0.748	0.039	UC206-18S6	UC206-18S7	0.197	0.626	0.874	0.236	M6×0.75	0.34
						UC206S6	UC206S7						
						UC206-19S6	UC206-19S7						
						UC206-20S6	UC206-20S7						
35	1 1/4	2.835	1.689	0.787	0.043	UC207-20S6	UC207-20S7	0.217	0.689	1.000	0.256	M8×1	0.54
						UC207-21S6	UC207-21S7						
						UC207-22S6	UC207-22S7						
						UC207S6	UC207S7						
40	1 1/2	3.150	1.937	0.827	0.043	UC207-23S6	UC207-23S7	0.236	0.748	1.189	0.315	M8×1	0.68
						UC208-24S6	UC208-24S7						
						UC208-25S6	UC208-25S7						
						UC208S6	UC208S7						
45	1 5/8	3.346	1.937	0.866	0.043	UC208-26S6	UC208-26S7	0.236	0.748	1.189	0.315	M8×1	0.78
						UC209-27S6	UC209-27S7						
						UC209-28S6	UC209-28S7						
						UC209S6	UC209S7						
50	1 7/8	3.543	2.031	0.945	0.043	UC209-29S6	UC209-29S7	0.236	0.748	1.283	0.354	M8×1	0.87
						UC210-30S6	UC210-30S7						
						UC210-31S6	UC210-31S7						
						UC210S6	UC210S7						
55	2	3.937	2.189	0.984	0.059	UC210-32S6	UC210-32S7	0.276	0.874	1.315	0.354	M10×1.25	1.26
						UC211-32S6	UC211-32S7						
						UC211-34S6	UC211-34S7						
						UC211S6	UC211S7						
60	2 1/4	4.331	2.563	1.063	0.059	UC211-35S6	UC211-35S7	0.295	1.000	1.563	0.413	M10×1.25	1.67
						UC212-36S6	UC212-36S7						
						UC212S6	UC212S7						
						UC212-38S6	UC212-38S7						
						UC212-39S6	UC212-39S7	7.5	25.4	39.7	10.5		1.52
													1.45



RODAVIGO, S.A.
RODAMIENTOS VIGO, S.A.

www.rodavigo.net

+34 986 288118
Servicio de Att. al Cliente



NIPPON PILLOW BLOCK CO., LTD.

HEAD OFFICE/Main Plant

2306 Hirao Miharaku Sakai Osaka 587-0022 JAPAN
TEL: 072-361-3752 FAX: 072-361-4173 E-mail: info@fyhbearings.com

SALES E-mail: exports@fyh.co.jp

FYH BEARING UNITS USA INC.

13201 FYH Drive Huntley, Illinois 60142, USA
TEL: 847-487-9111 FAX: 847-487-9222 E-mail: sales@fyhusa.com

fyhbearings.com

2011.07