

Pneufit® C

Push-in fittings, metric
Ø 4 ... 16 mm O/D tube

- Pneufit® C fittings are ready to use, offering fast assembly with no need for tools providing optimum flow
- Pneufit® C offers a broad range of over 1,000 composite push-in pneumatic fittings to complement our established all brass Pneufit® series
- Releasable stainless-steel grabbing to grip nylon or polyurethane tube (85 or 95 durometer)
- Nickel plated brass components provide corrosion and contamination resistance and an extended life
- Pre applied thread sealant on all taper threads and recessed captive o-ring on parallel threads provides optimum rapid sealing

Technical Data

Medium:
Compressed air

Max. operating pressure:
10 bar

Vacuum:
750 mmHg

Tube sizes:
4, 6, 8, 10, 12 and 16 mm

Thread sizes:
M5, M6, 1/8, 1/4, 3/8 and 1/2
ISO G, ISO Rc and ISO R

Tubing types:
Nylon 11 or 12
Polyurethane 85, 95 or 98 durometer

Operating temperature:
0 ... +60°C

Warning:
The Norgren Pneufit® C range must not be used in vehicle air braking or ancillary systems. For push-in-fittings suitable for these applications, please refer to the Fleetfit range.

Materials

Body:
PBT

Seals:
NBR (silicone free)
u-packing and o-rings

Threaded bodies:
Nickel plated brass

Release sleeve and backing ring:
POM

Grab-ring:
Stainless steel

Collar:
Nickel plated brass

Thread sealant:
Chemitech G-175L



Method of assembly



1. Ensure that the end of the tube is cut square and free from burrs.
2. Push the tube through the collet into the fitting.
3. Continue pushing the tube through the o-ring until it bottoms on the tube stop, then pull back.
4. To disconnect push the tube into the fitting, hold down the collet and withdraw the tube.

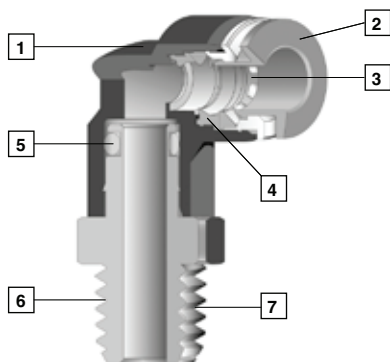

- 1 Impact resistant PBT body in black
- 2 Release buttons are red for metric, grey for inch.
- 3 Stainless steel grab ring with special design to retain softer tube and provide easy releasability.
- 4 Silicon free u-packing provides leak tight tube seal under side loading.
- 5 Stem seal provides leak tight 360° swivel connection.
- 6 Nickel plated brass threads and notches on hex to signify NPT.
- 7 Pre-applied thread sealant on tapered threads and recessed captive o-ring on parallel threads.

Option selector















C0 ★★★★★★



Pneufit® C

Push-in fittings, metric
 Ø 4 ... 16 mm O/D tube

● Straight adaptors and connectors

Straight adaptor, BSPT thread (external + internal hex) C0125 	Straight adaptor, BSPP thread (external + internal hex) C0225 	Straight adaptor, metric or BSPT thread (internal hex only) C012A/C022A 	Female adaptor, metric or BSPP thread C0226 	Straight union C0020 	Straight union (unequal) C0020 
Stem reducer C0023 	Stem expander (stem/tube) C0023 	Bulkhead union C0029 	Straight adaptor, BSPP thread (female bulkhead) C0232 	Stem union (equal) C0022 	Stem union (unequal) C0022 
Plug C0004 	Cap (female plug) C0012 				

● Elbow adaptors and connectors

Union elbow C0040 	90° swivel elbow adaptor, BSPT thread C0147 	90° swivel elbow adaptor, BSPP thread C0247 	Stem elbow C0043 	90° swivel elbow adaptor (extended), metric or BSPT thread C0154/C0254 	90° swivel elbow adaptor (female), metric or BSPT thread C0148/C0248 	Bulkhead union elbow C0049 
--	--	--	---	--	---	---













● Y and quadruple connectors

Union Y (equal + unequal) C0082 	Swivel Y adaptor, BSPT thread C0188 	Swivel Y adaptor, BSPP thread C0288 	Stem Y (equal + unequal) C0084 	Quadruple stem reducer C0096 	Quadruple Y union, BSPT thread C0195 	Quadruple Y union, BSPP thread C0295 	Quadruple reducer C0097 
--	--	--	---	---	---	---	--

● Tee connectors and adaptors

Union tee (equal) C0060 	Union tee (unequal) C006A 	Swivel tee adaptor, BSPT thread C0167 	Swivel tee adaptor, BSPP thread C0267 	Swivel side tee adaptor (female), metric or BSPT thread C016C/C026C 	Stem tee (equal) C0063 
Stem tee (unequal) C0063 	Stem side tee (equal) C0064 	Stem side tee (unequal) C0064 	Swivel side tee adaptor, BSPT thread C0168 	Swivel side tee adaptor, BSPP thread C0268 	

























● Banjo flow controller

Banjo flow control (out), BSPT thread C0TA0 	Banjo flow control (out), metric or BSPP thread C0K51 	Banjo flow control (in), BSPT thread C0SA0 	Banjo flow control (in), metric or BSPP thread C0L51 	Shrouded banjo (out), BSPT thread C0TBO 	Shrouded banjo (out), metric or BSPP thread C0KBO 
Swivel speed control (out), BSPT thread C0T56 	Swivel speed control (out), metric or BSPP thread C0K56 	Speed control and pilot check, metric or BSPT thread C01GN 	Speed control and pilot check, metric or BSPT thread C02GN 	In-line flow control C00GE 	In-line flow control C00GP 

Pneufit® C

Push-in fittings, metric
 Ø 4 ... 16 mm O/D tube

● Cross and manifolds

Union cross C0090 	Manifold union C00D3 	Male manifold, BSPT thread C01D3 	Stem manifold C00J3 		
Banjo, metric or BSPP thread COA51 	Banjo (with top port), metric or BSPT thread COD51, COE51, COF51, COG51 	2x swivel elbow adaptor, BSPT thread COQ51 	2x swivel elbow adaptor, BSPP thread COB51 	3x swivel elbow adaptor, BSPT thread COH51 	3x swivel elbow adaptor, BSPP thread COC51 
Single universal tee, BSPT thread CON71 	Single universal tee, BSPP thread COA71 	Double universal tee, BSPT thread COQ71 	Double universal tee, BSPP thread COB71 	Triple universal tee, BSPT thread COH71 	Triple universal tee, BSPP thread COC71 
Branch adaptor, BSPT thread CON70 	Branch adaptor, metric or BSPP thread COA70 	Female branch adaptor, BSPT thread CO*7K 	Female branch adaptor, metric or BSPP thread CO*7J 	Double branch adaptor, BSPT thread COQ70 	Double branch adaptor, BSPP thread COB70 
Triple branch adaptor, BSPT thread COH70 	Triple branch adaptor, BSPP thread COC70 				

● In-line non-return valve

In-line non-return valve C00GL 	In-line non-return valve (in), BSPT thread C01G2 	In-line non-return valve (in), metric or BSPP thread C02G2 	In-line non-return valve (out), BSPT thread C01G3 	In-line non-return valve (out), metric or BSPP thread C02G3 
---	---	---	--	--

● Self sealing adaptors

Straight adaptor, BSPT thread C0124 	Straight adaptor, BSPP thread C0224 	Straight union C002J 	Swivel elbow, BSPT thread C014J 	Swivel elbow, BSPP thread C024J 
--	--	---	--	--

● Hand valves

3/2 shut-off valves, BSPT thread C01GG 	3/2 shut-off valves, BSPT thread C01GH 	3/2 shut-off valves, BSPT thread C01GJ 	3/2 shut-off valves C01GF 
---	---	---	--