



Factory
Automation
Incorporating



Innovative Solutions
for the Food Processing,
Beverage & Packaging Industry



CONTENTS

Introduction	03
Our market leading product brands	04
Our global reach	05
Delivering expertise, solutions and value to the food and beverage industry	06
Process Automation	08
Sorting Machines	10
Dairy Production	12
Meat Processing	14
Non-Food Area	16
Beverage Dispense	18
PET Bottling	20
Continuous Inkjet Printing	22
Functional Safety Solutions for Safety Technology	24
Lean Manufacturing	26
Online Tools and Technical Support	27

Breakthrough Engineering for a Better World

Norgren is part of global engineering organisation IMI plc. IMI is at the forefront of delivering the solutions we need in a changing world and is focused on **creating tremendous value by solving key industry problems** in attractive markets and employing the best.

Norgren has a proud history of creating innovative engineering solutions in precise motion control and fluid technology, and we collaborate with our customers across more than 50 countries in critical areas such as Factory Automation, Material Handling, Rail, Energy, Process Control, Life Science and Commercial Vehicles.

From improving speed, productivity, reliability and efficiency of equipment, to generating significant energy and cost savings, or lowering total cost of ownership across many industries, Norgren's high-quality solutions are designed to help customers pursue progress, achieve new goals and overcome problems.

With market-leading industry expertise, we offer the capability, resources, engineering intelligence and global support infrastructure to tackle the largest project demands.

Our world-class portfolio of fluid and motion control products include Norgren, Buschjost, FAS, Herion, Kloehn, Maxseal and Thompson Valves. Supplied either individually or combined into powerful customised solutions to meet customer needs.

Breakthrough engineering you can count on.

**Breakthrough
Engineering
for a Better World**



Our market leading product brands

The combination of our product brands' trusted reputation and long history underpins our position as a leading global supplier of motion and fluid control technologies.



With over 80 years industry experience, the Norgren brand includes a wide range of high quality pneumatic and fluid control products such as actuators, air preparation products, pressure switches, fittings and valves.



Successful in the market for over 80 years, Buschjost is a market leading range of process and multimedia solenoid valve technology and system solutions.



The FAS range offers a comprehensive portfolio of globally acclaimed miniature fluid control solutions which provide successful, consistent performance at the heart of demanding applications. Specialising in miniature solenoid valve technology for 10 mm and 15 mm valve applications.



For over 50 years the Herion brand has specialised in solenoid valves, NAMUR valves and hydraulic solutions for mechanical and pneumatic press and press safety technology.



Proven in the field for over 50 years, the Maxseal brand offers extremely high quality stainless steel solenoid valves, for harsh environments such as offshore oil & gas and coastal applications.



Our Global Reach

With established manufacturing facilities globally, we have the capability to cope with the most demanding of international projects. With a sales and service network in 50 countries, we have the reach and capability to ensure continuity of supply and local support where it is needed.

Sales & Service in 50 countries

- 📍 Norgren sales, manufacturing and technical centres
- 📍 Norgren sales locations
- 📍 Norgren manufacturing locations

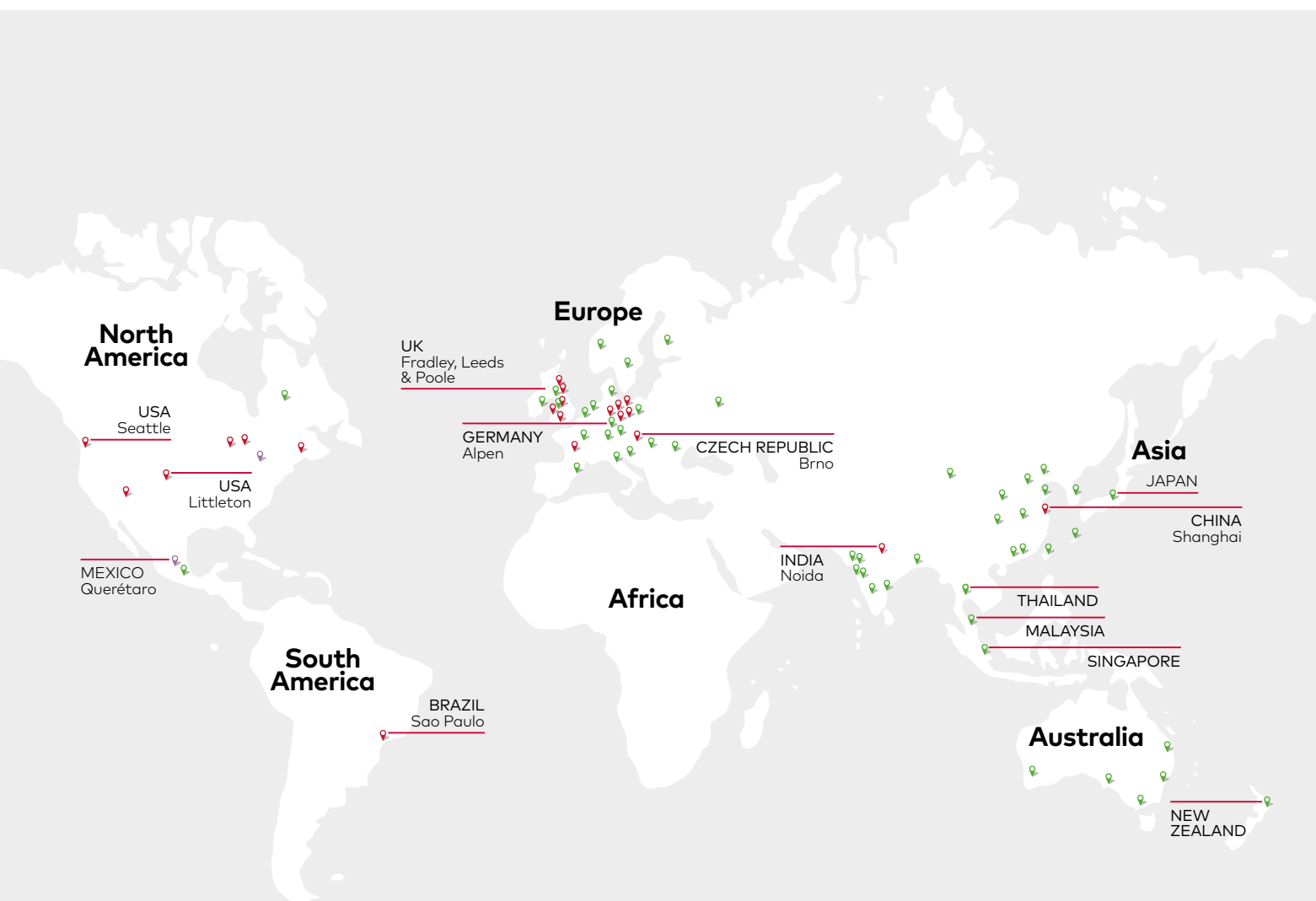

Delivering expertise, solutions and value to the food and beverage industry

Reliability through expertise and experience

Norgren has dedicated over 25 years to meeting the unique needs of the global food and beverage industry, delivering pioneering products and bespoke solutions.

Close collaboration with customers, and a search for innovation that offers real Breakthrough Engineering, has resulted in millions of hours of reliable service from our PET bottling, ink jet, processing & packaging, dispense and food service equipment.

From handling 40 bar air for PET bottle blowing, to aggressive solvents in ink jet printing; from wash-down chemicals to lime scale-free coffee machines, we have an impressive track record of helping the world's largest food companies improve efficiency, save energy and optimise performance.

Setting the standard

Whether it's FDA-compliant materials or solutions for ATEX environments, our intimate knowledge of supplying components and solutions for applications in the food, splash and non-food zones, helps ensure your system meets relevant regional and international standards, and codes of practice.





Processing & Packaging



Sorting



Dairy



Meat Processing



Packaging



Beverage Dispense



Coffee Machines



PET Bottling



PET



Inkjet printing



Control Ink

08 Complete Range of Innovative Solutions



Process Automation

Through our global technical centres, and local support, Norgren uses the latest materials and technologies to offer a range of standard and hygienic solutions for process automation applications. These include:

- » Flexible, compact valve islands with Devicenet, Profibus and Ethernet protocols for all your process control needs
- » A range of corrosion-resistant stainless steel products
- » High flow angle seat valves to handle steam and aggressive fluids
- » High quality diaphragm valves that are resistant to corrosion
- » Proportional control valves that offer an accurate and stable response, with lower air consumption
- » A comprehensive selection of pressure switches & sensors
- » Air preparation equipment available in modular units to deliver a continuous supply of clean, dry and CO₂ free (<1 ppm) gas



Complete Range of Innovative Solutions 09

Products for Process Automation

Valve Islands



Stainless steel solutions



Proportional control



Air Preparation equipment



Angle Seat Valves



Ball valves

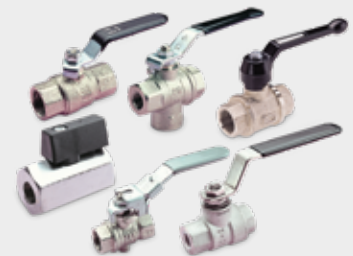

Diaphragm valves

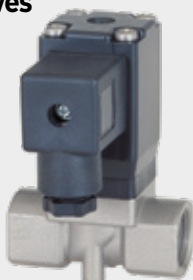

Sterile air for food & beverage



Pressure switches & sensors



Sorting Machines

Sorting machines use a combination of mechanical and optical sorting technologies to separate or sort similar items. Different ejection systems are required depending on the items being sorted, with safety, speed and reliability being a priority for end users.

We provide a broad range of solutions for sorting applications including food, beverage and grain sorting.

- » Pusher systems for bottles and boxes
- » Air Ejection Systems for small goods e.g. grains, rice
- » Mechanical ejection systems (flaps) for Bigger Products e.g. Potatoes
- » Inspection camera cleaning
- » Water flow control



Products for Sorting Applications

- » **Plastic solenoid actuated valves** for water splashing
- » **Valve islands & fittings**
- » **High speed ISO cylinders** to drive flaps and let the food flow
- » **IVAC** for fast response time (5 cycles per second)
- » **High speed valves** for ejectors



Plastic solenoid actuated valves



High speed ISO cylinders



High speed valves



Valve islands & fittings



IVAC



Dairy Production

Our range of robust, rugged and reliable pneumatic products, offer a solution for applications in the dairy industry:

- » Herd management including drafting systems and parlour gates for cow segregation
- » Automated milking systems
- » Animal feed
- » Cluster cleaning
- » Scraper systems
- » Milk processing (pasteurising, filling and packaging)
- » Cheese making



Products for Dairy Applications

Cylinders

» **Norgren ELION Electric Actuators** to provide accurate and repeatable positioning.



» **ISOLine cylinders** with heavy duty wiper seal and adjustable cushioning system for changing loads. Stainless steel versions also available.



» **IVAC Integrated valve and actuator** to reduce energy consumption, weight and installation time.



» **Cleanline cylinders** hygienically designed according to EN1672-2 with an IP67 protection class for washdown applications.



Valves

» **VS18** for Process Control

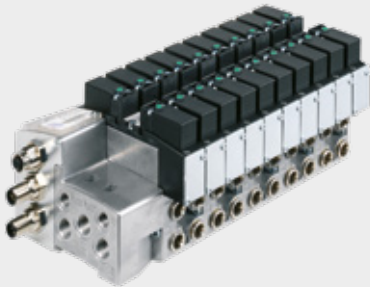

» **83150 2/2-way valve** for milking system cleaning and sterilising



» **82400 2/2-way seat valve** for cleaning and sterilising



» **84520 2/2-way diaphragm valve** for cleaning steam valve



Air Preparation

» **Excelon® Plus air preparation** with best in class water extraction (98% at 100% flow)



» **Stainless steel air preparation** for corrosive and washdown applications



Meat Processing

From air preparation to valves and actuators, our robust and reliable products offer a solution for any application in the meat processing industry:

- » Knocking Pen
- » Meat Tensioning
- » Transfer Chain
- » Gates
- » Sorting
- » Blood Processing
- » Hand Wash Basin
- » Cleaning and Sterilisation
- » Multistage Hide Puller
- » Door Controls

Products for Meat Processing Applications

Cylinders

» **Norgren ELION Electric Actuators** to provide accurate and repeatable positioning.

» **ISOLine cylinders** with heavy duty wiper seal and adjustable cushioning system for changing loads. Stainless steel versions also available.

» **IVAC Integrated valve and actuator** to reduce energy consumption, weight and installation time.



» **Cleanline cylinders** hygienically designed according to EN1672- 2 with an IP67 protection class for washdown applications.

» **Special cylinders** to tenderise meat. Designed to eliminate bug traps with customised hooks to carry out the tensioning operation.

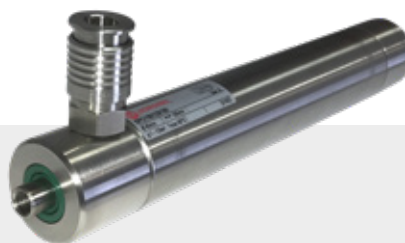



Valves

» **Valves kits** available to replace the common knee wand found in most abattoirs - Stainless steel pilot valve with a Super X valve, fittings and silencers designed to avoid wastage of water.



» **Valves** for use in the cleaning and sterilization unit and vertical water scalding process for cleaning equipment like hooks and tongs.



Air Preparation

» **Excelon® Plus air preparation** with best in class water extraction (98% at 100% flow)



» **Stainless steel air preparation** for corrosive and washdown applications



➔ Find out more
norgren.com



Non-Food Area

Norgren aims for design excellence in all areas. Even though this stage of the process involves no contact with food, our engineers look not only to meet, but also to set quality standards using materials that are easy to clean and resistant to corrosion.

Our products and solutions include air preparation for pneumatic components; Stepper, rodless and guided cylinders; vacuum products; angle seat valves; valve islands with common industry protocols and IVAC for optimised energy savings of up to 50%.

Applications include:

- » Conveying
- » Secondary packaging
- » Palletising
- » Dispensing equipment for consumer and industrial adhesives, sealants and coatings
- » Thermoforming packaging
- » Modified atmosphere packaging
- » Gas sterilisation flow control



Products for Non-Food Area

Air Preparation



IVAC for optimised energy consumption saving up to 50%



Valve Islands



Stepper cylinders



Rodless cylinders

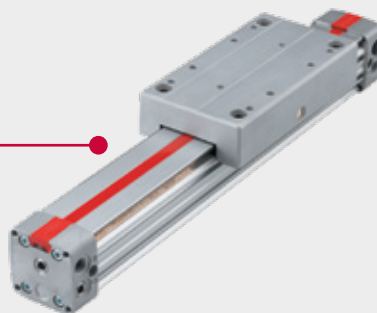

Solenoid Valve



Guided cylinders

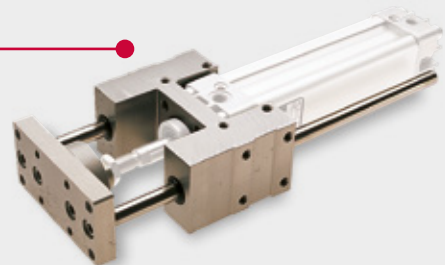

Angle Seat Valve



Vacuum products



Beverage Dispense

Beverage dispense applications require high-quality, reliable systems and low maintenance costs, together with hygienically designed and washdown approved components.

Our high performance solenoid actuated plastic valves are permitted according to NSF and FDA, reliably control cold water, hot water, steam and the necessary cleaning processes, and are suitable for a number of beverage dispense applications including:

- » Coffee machines (Fully automatic & semi automatic)
- » Drinking water dispenser
- » Vending machines
- » Cold & hot water devices
- » Soft drink machines
- » Ice cream machines

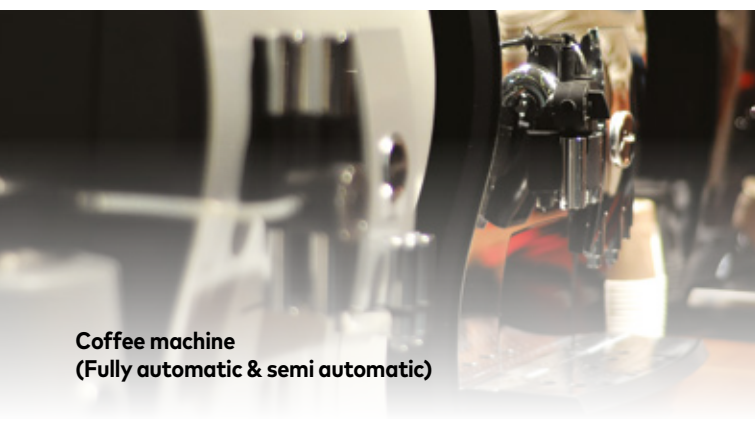

Coffee machine
(Fully automatic & semi automatic)



Drinking water dispenser



Vending machines

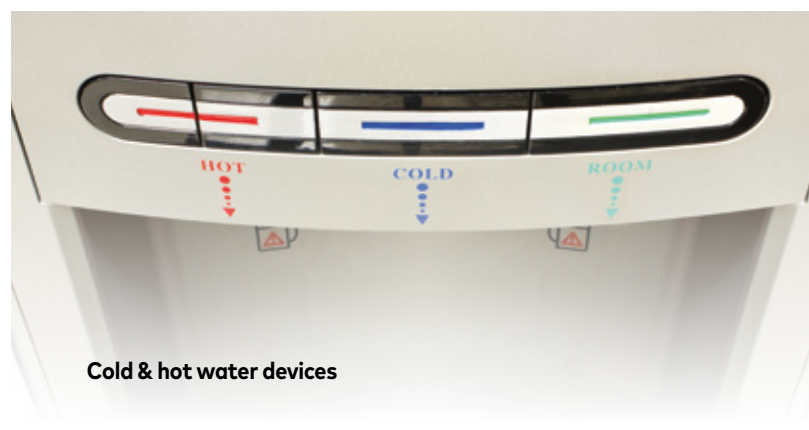

Cold & hot water devices



Soft drink machines



Cream- & ice machines

Valves for Beverage Dispense Applications

Beverage Dispense valves

Robustly designed, these solenoid valves are resistant to all media, specifically water. Water quality can vary considerably globally, with various degrees of hardness and calcification. The solenoid valve materials are perfectly designed to meet the various requirements and ensure the required corrosion resistance, high reliability and long service life.

- » Reduction in the number of fittings when using valve chains
- » Reduction of potential leakage points
- » Corrosion resistant & increased service life
- » "Plug and use" concept – quick installation of modules (up to 7 valves can be linked)
- » Glow wire resistant acc. to IEC/EN 60695
- » Use of approved wetted materials in accordance with NSF, FDA, and BfR
- » VO (EG) 1935/2004
- » UL recognized coils available on request
- » For Milk, Flavours & Syrup, Water, Steam
- » Single or stackable valves
- » Resistant to limescale
- » Up to 15 bar
- » Up to 125°C
- » 100% Leadfree
- » 100% Nickel free

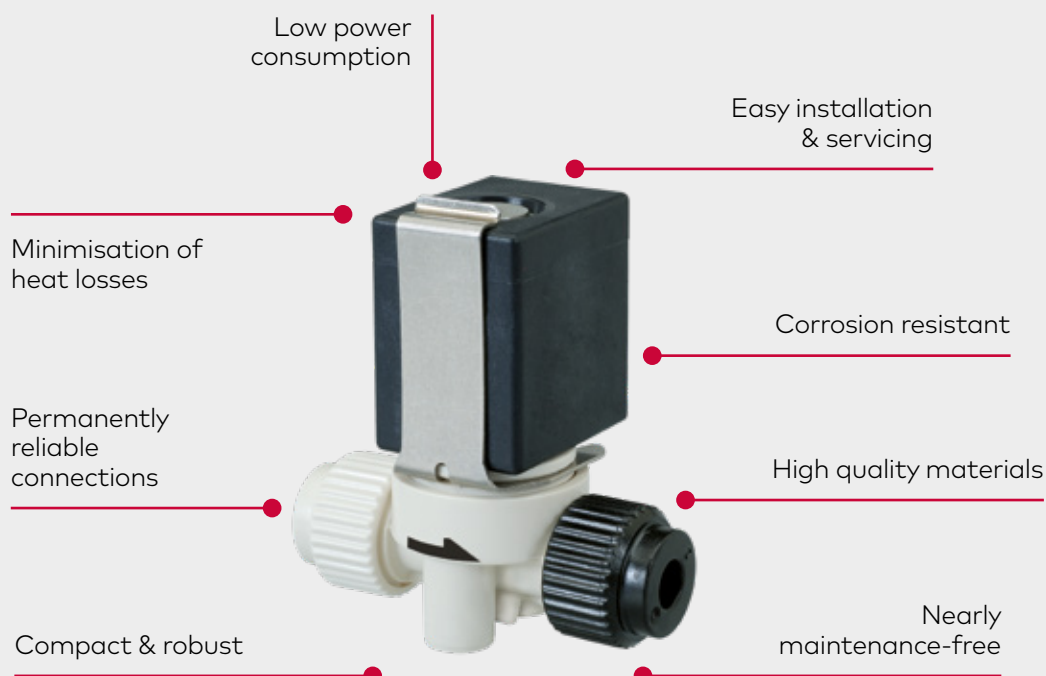
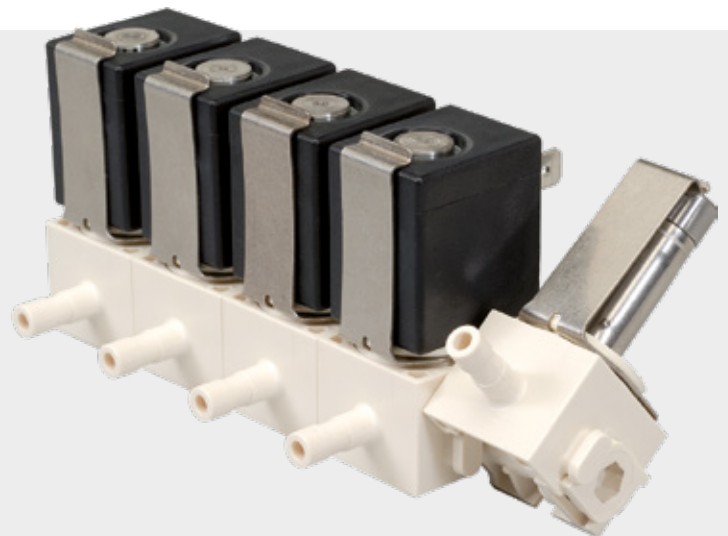



PET Bottling

Building on three decades of PET engineering excellence, we remain a pioneering force in this sector, constantly driving performance and reliability improvements. Our patented plastic piston technology and experience in valve positioning allows us to reduce dead space volume and increase productivity.

Filling

Food safety is a vital consideration in filling applications. To avoid the possibility of contamination, we ensure that all system components directly or indirectly in contact with the main food/drink product – such as cylinders for filling valves, for example – are engineered from corrosion resistant, non-toxic and non-absorbent material.

Rotary stretch blow moulding

Norgren is a complete 'air' solution supplier to the PET industry. Our expertise covers 7 bar standard pneumatics to 20 bar P1 and 40 bar P2 solutions, including 11 functions on the blowing wheel for valving, as well as 24 functions for air recovery and management.

Our range offers 40 bar blowing blocks, cooling valves, air recovery products & solutions, pneumatic stretch actuators, and capping cylinders for hot & cold fill processes.



Products for PET Bottling Applications

Pneumatic stretch
actuators



Capping cylinders
for hot fill & cold
fill processes

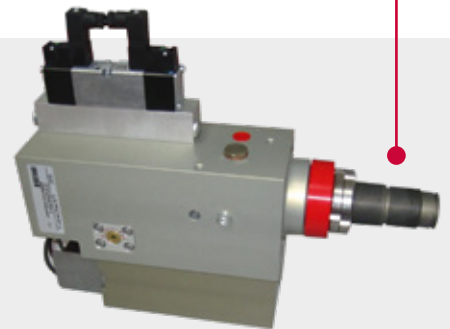

Cooling valves



40 bar blowing
blocks



Cylinders for
filling valves



High pressure filter with safety
valve ISO 13849 Pld, KAT 3
SF and Dome regulator

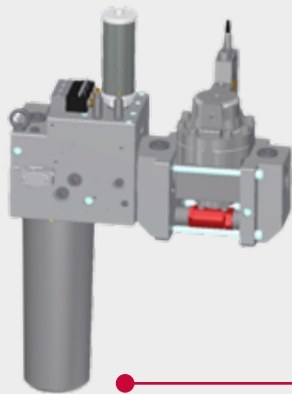

Continuous Inkjet Printing



We are the world's leading supplier of miniature solenoid valves for Continuous Inkjet (CIJ) printing. Many of the world's leading CIJ printer brands use Norgren technology within their fluid circuits, due to their high durability and suitability for aggressive solvents and inks. Our range is adaptable for many types of printer and labelling machines and includes cylinders, in-line valves and precision solenoid valves.

Thanks to close collaboration with key global customers, Norgren has developed miniaturized and robust valves for highly integrated solutions to ensure key functions in the customers' devices.

- » Precision miniature design to fit maximum fluidic functions into a minimum footprint
- » Superior material compatibility
- » Designed to avoid clogging
- » Durable in extreme environments e.g. temperature, vibration, humidity, etc.
- » Long life expectancy to reduce maintenance costs



Valves for Inkjet Printing Applications

Valves to allow precision control of ink into printing stations

- » Control ink/solvent mixing
- » Control liquid distribution within the printer
- » Transfer ink & make-up from cartridges to main tank
- » Transfer to print head
- » Collection of return path from print head to printing station
- » Specific wetted material coating for opaque inks (high viscosity inks)

Valves to allow accurate control of the ink beam and washing/flushing functions

- » Ink or make-up supply to print head
- » Specific precision designs to maximize reliability
- » For dye, food grade or opaque inks

[In-Line MICROSOL]



15 mm body

2-way

In-line design for better integration

[MICROSOL MS-E]



4W / 0.4W

15 mm body

Up to 5 bar

3-way Uni

[MINISOL N]

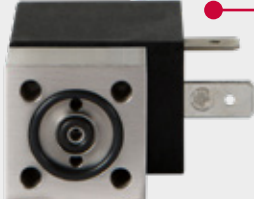

2-way or 3-way

Orifice 2.0mm

22 mm body

[PICOSOL 2/2 MS]



Highly customizable design

10 mm body

Power consumption 4.5W / 0.5W

Ø 1mm

[PICOSOL 3/4 MS]







Functional Safety Solutions for Safety Technology

Machinery Directive 2006/42/EC and DIN EN ISO 13849 Part 1 and Part 2

With an effective date 29.12.2009 the Machinery Directive 2006/42/EC replaced the previous Machinery Directive 98/37/EC and defines fundamental standards of Machine Safety in the European domestic market. Only machines, that comply with the demands of the Machinery Directive, are allowed to be introduced on the European market. This includes new machines as well as existing machines that have experienced significant or considerable variations or modifications or have served a different use. In accordance with conditions of the Machinery Directive and the guideline, compliant machines must be furnished with CE-labelling, Declaration of Conformity and the required user information. The harmonized standard DIN EN ISO 13849 (Model B Standard) assists the Machinery Directive with the technical implementation of the safety demands and reliable control systems. It provides generally important principles in terms of the planning and evaluation of safety-related parts of a control system, control system architecture as well as the quality of risk mitigation and the validation procedures for the safety function, categories and Performance Levels of safety-related parts of controls.



Find out more
norgren.com

Safety and Risk assessment

A machine should be constructed to guarantee safety as much as possible. Any potential danger must have its risk reduced/minimized by protections or measures e.g. a pneumatic safety control system. For unavoidable residual risk, the corresponding necessary documentation must be provided. A comprehensive and standardized risk assessment will take place at the beginning of the process for the evaluation of the machinery safety.

Identification of safety function

If in the risk analyses hazardous movements were detected then, in accordance with the danger, counteracting safety functions must be defined and provided. Only after more precise definition of the actual safety function can the corresponding subsystems of the safety control system be adequately executed and interpreted.

- » Safe exhausting of a system
- » Stop of a hazardous movement
- » Stop and obstructing of a hazardous movement
- » Reversing a hazardous movement
- » Protection against accidental start-up and many others



Monitoring Confidence

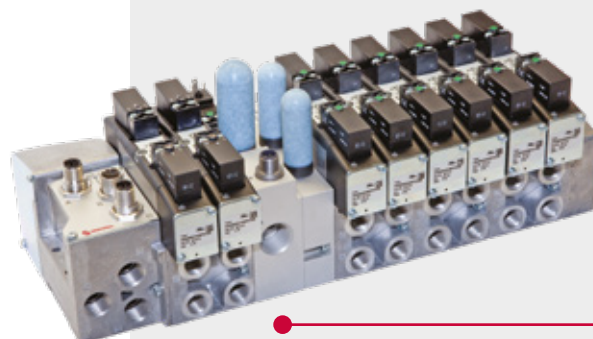

Risk Reduction



Professional Advice

SF = safety function
PL = performance level

SRP/CS = safety related parts of control systems
MTTFd = mean time to dangerous failure
DC avg = average diagnostic coverage
CCF = control cause failure

Iterative process for the design of the safety-related components of the control system

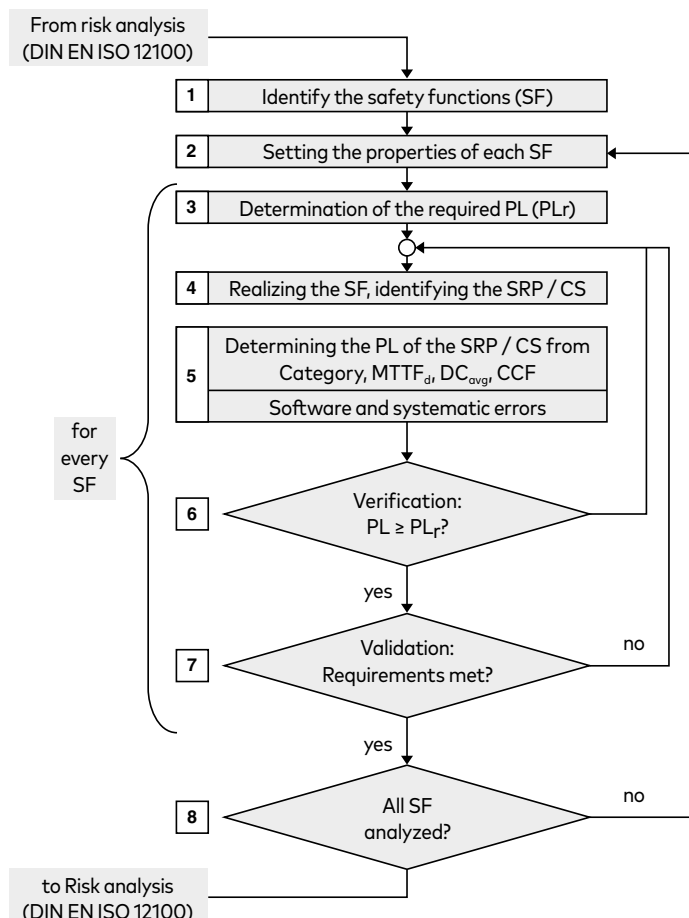



Lean Manufacturing

Norgren are dedicated to Lean Manufacturing and Continuous Improvement to improve the quality and delivery of our products and customer service by increasing value and reducing waste.

We follow key lean principles to ensure we focus on our customers needs and optimise our products, processes and services to provide the following benefits to our customers:

- » Increased manufacturing efficiency
- » Reduced unplanned downtime and shutdowns
- » Reduced lead times and inventory
- » Optimised new product development
- » Agile engineering partnerships

Benefits for the customer

- » Increase of plant efficiency and life time
- » Cost reduction due to less unplanned downtime and shutdowns
- » Optimal realization of new product designs – in time, on cost, at quality
- » Short reaction- and lead times supporting on time availability of planned and unplanned orders
- » Customized transport- and packaging solutions reducing stock receipt time and increase environment protection
- » Innovative solutions based on cooperative and agile engineering partnerships

Online Tools and Technical Support



Website

Visit www.norgren.com for detailed product information, online ordering and a range of tools to help you save time and work efficiently



Norgren Express App

Find products and availability fast with our new mobile app available for iPhone and Android



Technical Support

Our dedicated technical team are available to help you specify the correct product for your application and provide full support throughout purchase and installation. Contact you local team today.



Norgren operates four global centres of technical excellence and a sales and service network in 50 countries, as well as manufacturing capability in Brazil, China, Czech Republic, Germany, India, Mexico UK and the USA.

For information on all Norgren companies visit

www.norgren.com

Supported by distributors worldwide.

For further information, scan this QR code or visit www.norgren.com



Norgren, Buschjost, FAS, Herion, Kloehn, Maxseal and Thompson Valves are registered trademarks of Norgren companies.

Due to our policy of continuous development, Norgren reserve the right to change specifications without prior notice.

z9590BR en/07/20

Selected Images used under license from Shutterstock.com and iStock

IMI

Incorporating

 **BUSCHJOST**

 **FAS**

 **HERION**

 **KLOEHN™**

 **MAXSEAL**

 **THOMPSON VALVES™**