

CAM FOLLOWERS

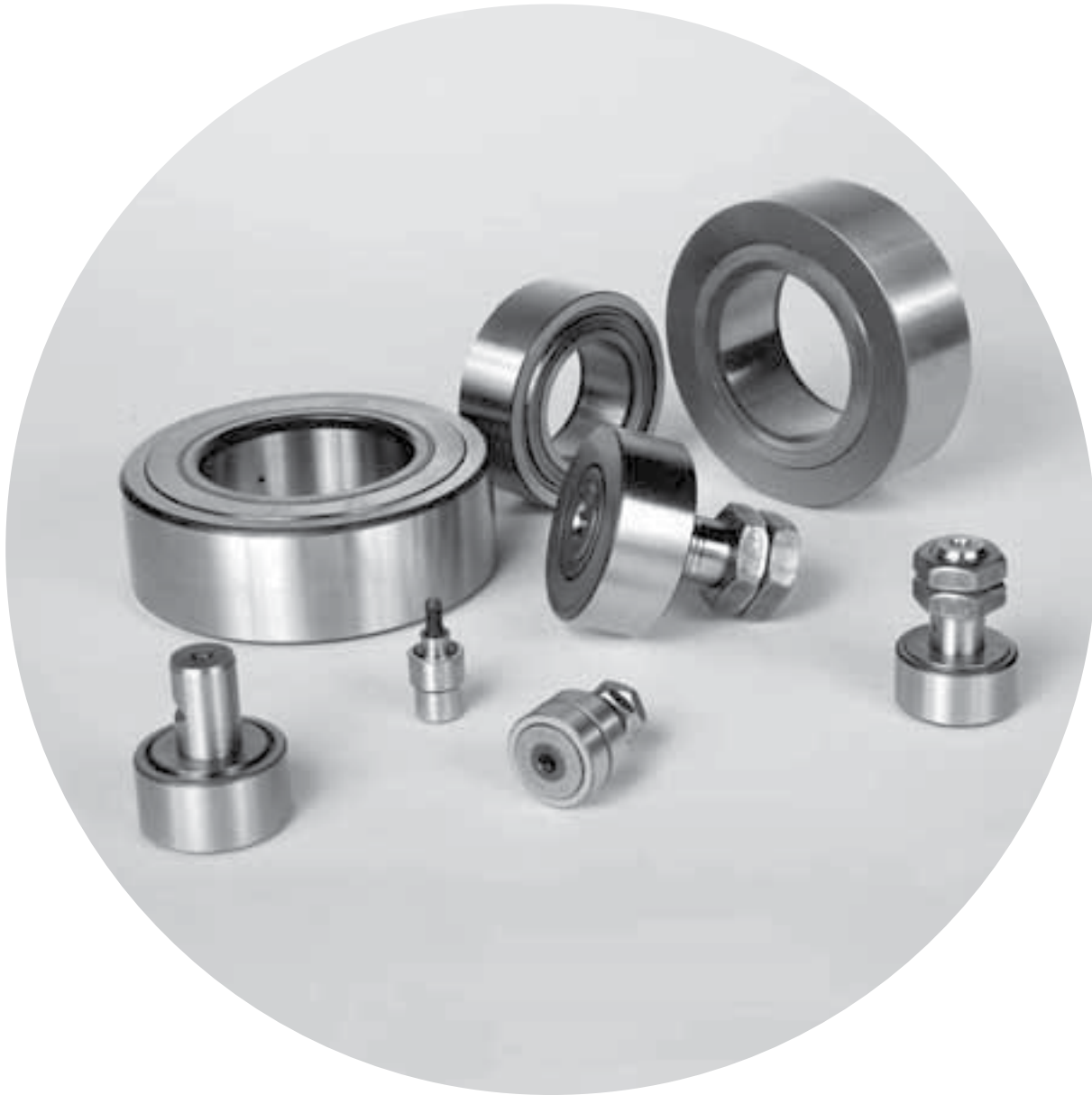

Technical features

Cam followers



Nadella cam followers are designed to run directly on various types of surface such as cams, ramps and slideways.

In order to satisfy the operating conditions imposed on this type of bearing - heavy radial loads usually accompanied by substantial and repeated shocks, the various Nadella cam followers have these common advantages:

- heavy section outer ring for carrying load and limiting deformations that reduce the load capacity of the bearing
- convex outer ring tolerating out-of-parallelism of contact surfaces or cylindrical outer ring for reducing contact pressure
- oil holes situated under the needles enabling lubricant replenishment through the shaft
- full complement of needles or rollers providing maximum dynamic and static load capacities

Cam followers can be equipped with an eccentric stud in order to allow setting the preload during the mounting. Cam followers can be equipped with plastic seals or metallic shields for retaining lubricant.

Besides the standard products in the catalogue, Nadella manufactures several variations for specific conditions of use.

Reference standards are:

ISO 7063 – Needle roller bearings – Track rollers – boundary dimensions.

TO USE AS FOLLOWERS

When the cam followers or the wheels are used for running on a rail or a cam, under the load there is a plastic deformation of the outer ring that reduces the load distribution between the rolling elements of the bearings. The tables in the following pages list two different values of the basic load of the bearing depending from the use and mounting.

- the load capacity **C** valued according to standard ISO 281 for bearings, for lifetime calculations when mounting with the cylindrical outer ring in a hole.
- the load capacity **C_w**, for lifetime calculations when mounting with the cylindrical outer ring running in contact with a cam or plain guide rail.

In addition to the load capacity of the bearing you must consider the strength of the outer ring and of the stud in the cam followers.

Dynamic limit load **F_r**: it is the load which should not be exceeded when follower is subject to repeated torques. Static limit load **F_{0r}**: it is the maximum strength limit that the follower can exceptionally support.

In case of use like a wheel the strength of the raceway must be considered. For more details, please ask to Technical Service Nadella.



Technical features

Cam followers

TYPES AND OPERATING CONDITIONS

Full complement needle followers types GC

These followers are recommended under following conditions:

- low speeds
- high radial loads
- oscillating motions

Convex outer ring (**GC**) or cylindrical (**GCL**)

With eccentric stud (**GCR** or **GCRL**)

Starting from dimension 16 can be equipped with contact plastic seals (suffix **EE**) or contact metallic shields (suffix **EEM**)

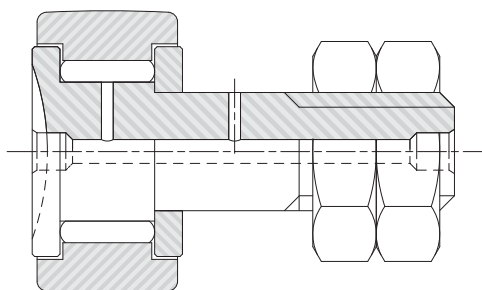

Single-row full complement roller followers types GCU

Their installation is especially recommended for:

- high speeds
- limited and intermittent axial loads
- heavy radial loads

Convex outer ring (**GCU**) or cylindrical (**GCUL**)

With eccentric stud (**GCUR** or **GCURL**)

With metallic shields (suffix **MM**)

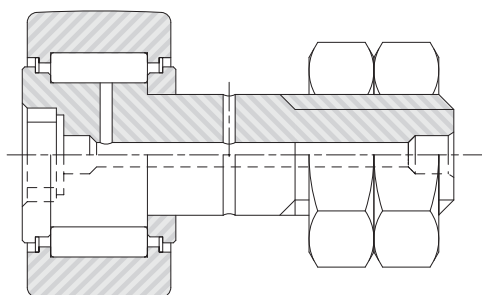

Double-row full complement roller followers types NUKR.2SK

Their installation is especially recommended for:

- high speeds
- limited axial loads
- heavy radial loads

Outer ring with optimised profile with decreasing curvature from middle of the wheel

With eccentric stud (**NUKRE**)

With metallic shields (suffix **MM**)

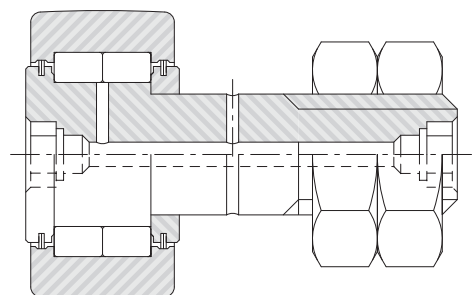

Small single-row full complement needle followers type FP

Their installation is especially recommended for:

- low speeds
- heavy radial loads
- oscillating motions

Convex outer ring (**FP**) or cylindrical (**FPL**)

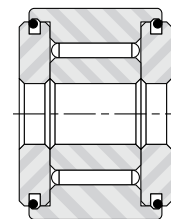

Single-row full complement needle followers type FG

Their installation is especially recommended for:

- low speeds
- heavy radial loads
- oscillating motions

Convex outer ring (**FG, FP**) or cylindrical (**FGL, FPL**).

Cam followers **FG** can be equipped with contact plastic seals (suffix **EE**) or contact metallic shields (suffix **EEM**).

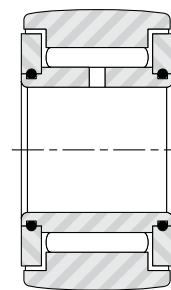

Technical features

Cam followers

Single-row full complement roller followers type FGU (heavy and light series)

Their installation is especially recommended for:

- high speeds
- limited and intermittent axial loads
- heavy radial loads

Heavy series is different from light series for the thickness of the outer ring which determinates an higher external diameter and an higher load capacity.

Convex outer ring (**FGU**) or cylindrical (**FGUL**).

Inner ring and lateral shoulders built in a single piece.

Metallic shields (suffix **MM**).

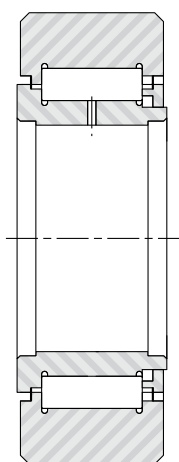

Double-row full complement roller followers type NUTR

Their installation is especially recommended for:

- high speeds
- limited axial loads
- heavy radial loads

Heavy series is different from light series for the thickness of the outer ring which determinates an higher external diameter and an higher load capacity.

Convex outer ring (**NUTR**) or cylindrical (**NUTR.DZ**).

Inner ring in three parts, not separable.

Metallic shields.

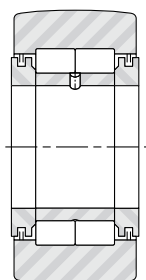

Single-row full complement needle followers type RNA 11000

These followers useable without inner ring on a treated shaft, are available with an inner ring starting from a shaft diameter 12 mm, and their installation is especially recommended for:

- intermediate speeds
- heavy radial loads
- oscillating motions

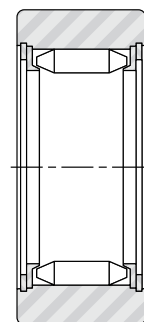

MISALIGNMENT TOLERANCES

Followers with a convex outer ring permit displacement in relation to the track surface up to a maximum slope like for the following table:

Cam follower type	
RNA 11 000 B6	1.5 in 1000
RNAB 11 000	15 in 1000
FG, GC, GCU	7 in 1000

TOLERANCES ON OUTER DIAMETER

For all type of follower:

- convex outer ring h9 on dim. D
- cylindrical outer ring h7 on dim. D

Out of roundness in accordance to ISO 7063

ADVICE ON ASSEMBLY

Positioning of the radial lubrication hole

In cases where the follower is subjected to high loads, shock or vibration, the lubrication hole situated under the needles should be positioned outside the loaded zone. The lubrication hole which is not visible on the cam follower with threaded stud is parallel to the screwdriver slot in the head of the stud. Where the head of the stud has a hexagonal socket, the position of the lubrication hole is indicated by the marking by the hole.

Technical features

Cam followers

Lateral support of followers

For followers type **FGU** shoulders on the shaft or other parts serving to retain the follower on the faces of the inner ring should have an outer diameter not less than dimensions d_A . Where there is considerable axial load or operation is subject to vibration, this outer diameter should be equal at least to dimension d_A listed in the tables.

For followers of **FG** series shoulders on the shaft should be equal at least to dimension d_A .

For the correct mounting of followers of **NUKR** series tighten axially the bearing, the minimum diameter advised for locking is d_A listed in the tables.

CAM FOLLOWERS GC, GCU AND NUKR SERIES

Tolerance on hole housing

The stud should fit easily into the hole in the mating member having a bore of tolerance H7. To ensure contact over the entire surface area of the yoke, the supporting face of the mating member should have a diameter of at least equal to dimension d_A . The locking torque applied to the nuts, as shown in the table of dimensions, is calculated to provide effective fixing of the follower.

Cam followers GC GCU NUKR series	Dimension d
Without eccentric stud	d H7
With eccentric stud	d1 H7

CAM FOLLOWERS FG FGU RNA1000 NUTR

Shaft tolerances

Cam followers NUTR FP FG FGU series	Dimension d
Load fixed in relation to the inner ring	h5 / h6
Load rotating in relation to the inner ring	k5 / j6
Load fixed in relation to the inner ring, moderate loads, high strength shaft	g6
Load fixed in relation to the inner ring, light loads, unhardened shaft, loose transition fit	f6

For RNA 11000 fitted with inner ring	Dimension d
Load fixed in relation to the inner ring	h5 / h6
Load rotating in relation to the inner ring	k5 / j6

For RNA 11000 without inner ring	Dimension Fw
Hardened and ground steel shaft	h5

The cylindrical tolerance, defined as the difference in radii of two coaxial cylinders (ISO Standard 1101), should normally be less than a quarter of the manufacturing tolerance. However, for high precision or high speed applications it is advised to restrict this tolerance to one eighth of the manufacturing tolerance.

LUBRICATION - OPERATING TEMPERATURE

Type **RNA 11000** followers are supplied with a coating of protective grease compatible with a lithium base grease.

As for the bearings the protective grease is not suitable for lubrication of the wheels.

All types of wheels and cam followers, with or without seals are supplied lubricated with a grease permitting operation in temperatures from -20 to +120°C. In the versions with metallic shields or in synthetic material (**EE-Teflon**) the exercise limit depends always on the lubricant. On request, these followers can be supplied with greases for high or low temperatures, or without grease (but protected against rust).

In any case, at temperatures of 150°C and above, cam followers must be specially heat treated and calculation of life should take account of reduced load capacity (consult Nadella Technical Department).

Use of a special grease for high temperatures may reduce the limiting speeds shown in the tables of dimensions.

The metallic shields **...EEM ...MM** enables operation up to 200°C with a suitable lubricant.

Technical features

Cam followers

ECENTRIC STUDS

To provide radial adjustment of the outer ring toward the hole of the housing at the time of installation, track rollers are available with eccentric bushing added to the track roller stud fitted with interference. In this way the position of the bearing can be settled for a value of $\pm k$. The eccentric bushing closes the lubrication hole on the stud.

As a standard eccentric bushing are supplied already mounted on the stud.

ACCESSORIES FOR FOLLOWERS

Cam followers with lubrication hole are supplied with cap and grease nipple. Insert the one or the other in the appropriate end seats in function of the side from which the lubrication will be performed.

The cap is completely inserted for all its length by pressure.

The nipple has instead a step that is not within the length of the hole for the portion that protrudes of 2.5 mm dimension h.

Cam followers of **GC** series and derived from dimension 16 up to 28 mm inclusive has a single axial hole at its top end for a grease nipple and a screw driver slot. The nipple protrudes from the edge of the head.

Cam followers of **GC** series, from diameter 30 mm and **GCU** series, with a hexagonal socket on head side, the nipple protrudes only if mounted on the stud side.

In cam followers **NUKR** series the nipple is always hid in the hexagonal socket.

The radial hole in the stud, if not used, is closed by the housing of the cam follower.

Concentric cam followers **GC GCU** and **NUKR** series are supplied with two nuts.

Eccentric cam followers **GCR GCU** **NUKRE** series are supplied with eccentric bushing, one nut, one lock washer, one flat washer

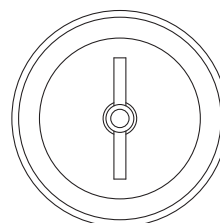
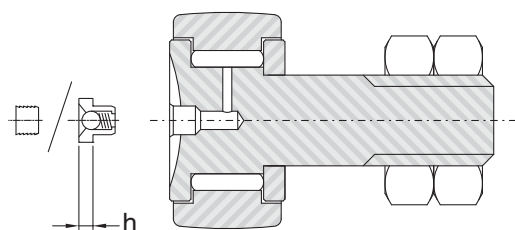

From GC16
to GC28

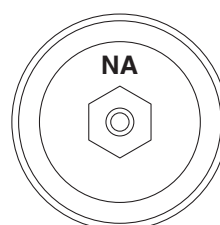
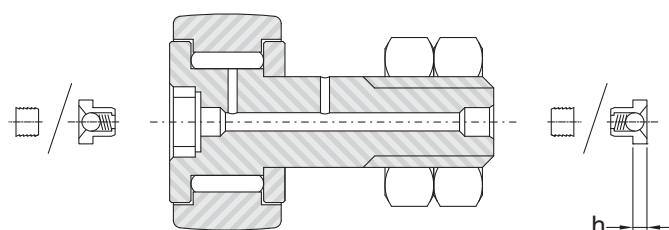

From GC30
and GCU

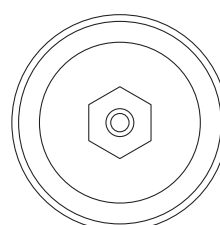
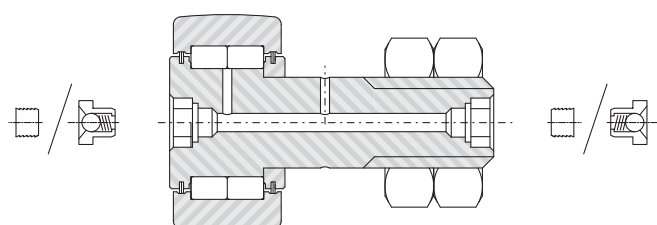

NUKR.2SK



Cam followers GC

GC, GCL series
without seals

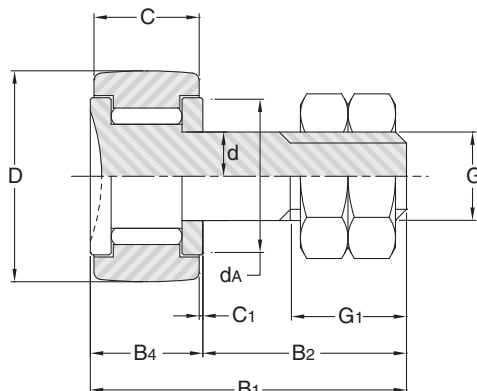

GC..., GCL...

Ø outer D mm	Designation 1)	C mm	d mm	B ₁ mm	B ₂ mm	B ₄ mm	G ₁ mm	Thread G mm	r _s min. mm	d _A 2) mm	C ₁ mm
	GC GCL										
10	10	8	4	19.5	11	8.5	6	M4x0.7	0.2	8.4	0.25
11	11	8	4	19.5	11	8.5	6	M4x0.7	0.2	8.4	0.25
12	12	9	5	22.5	13	9.5	7	M5x0.8	0.2	10.3	0.25
13	13	9	5	22.5	13	9.5	7	M5x0.8	0.2	10.3	0.25
14	14	9	6	26	16	10	8	M6x1	0.3	11.8	0.25
15	15	9	6	26	16	10	8	M6x1	0.3	11.8	0.25

1) Designation for cam followers

GC... Concentric cam followers with convex outer ring without seal

GCL... Concentric cam followers with cylindrical outer ring without seal

2) Minimum recommended abutment diameter in case of heavy axial loads or vibrations



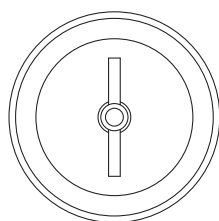

Clamping torque Nm	Basic capacities kN					Speed limits grease lubrication min ⁻¹	Weight kg	Ø outer D mm
	as a bearing		as a follower					
	Dyn. C	Stat. Co	Dyn. Cw	Dyn. Fr	Stat. For			
0.9	2.8	3.09	1.92	1.01	1.82	8500	0.006	10
0.9	2.8	3.09	2.12	1.43	2.58	8500	0.007	11
1.8	3.74	4.74	2.54	1.63	2.94	6600	0.011	12
1.8	3.74	4.74	2.16	2.75	3.89	6600	0.011	13
3.0	4.05	5.44	2.86	2.26	4.07	5700	0.016	14
3.0	4.05	5.44	3.04	2.83	4.65	5700	0.018	15



Needle cam followers GC..

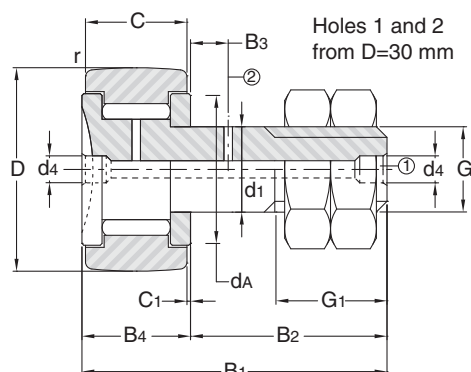

GC..

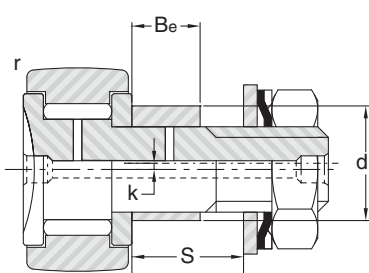

from GCR16.. to GCR52..

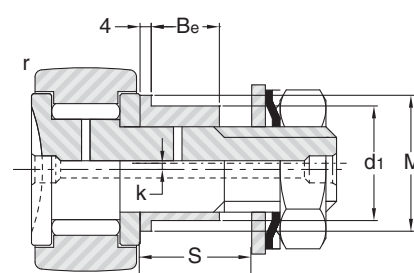

from GCR62.. to GCR90..

Ø outer D mm	Designation 1)	C mm	d 2) mm	d1 2) 3) mm	k 3) mm	M 3) mm	Be 3) mm	B1 mm	B2 mm	B3 7) mm	B4 mm	G1 mm	Thread G mm	dA 4) mm
	GC..., GC...EE GC...EEM													
16	16	11	6	9	0.5		8	28.7	16.5		12.2	8	M6x1	13.3
19	19	11	8	11	0.5		10	32.7	20.5		12.2	10	M8x1.25	15.3
22	22	12	10	14	1		11	36.7	23.5		13.2	12	M10x1.25	18.2
24	24	12	10	14	1		11	36.7	23.5		13.2	12	M10x1.25	18.2
26	26	12	10	14	1		11	36.7	23.5		13.2	12	M10x1.25	20.8
28	28	12	10	14	1		11	36.7	23.5		13.2	12	M10x1.25	20.8
30	30	14	12	16	1		11	40.7	25.5	6	15.2	13	M12x1.5	24.8
32	32	14	12	16	1		11	40.7	25.5	6	15.2	13	M12x1.5	24.8
35	35	18	16	21	1.5		14	52.6	33	8	19.6	17	M16x1.5	28.8
40	40	20	18	24	1.5		16	58.6	37	8	21.6	19	M18x1.5	33.8
47	47	24	20	27	2		17.5	66.6	41	9	25.6	21	M20x1.5	38.7
52	52	24	20	27	2		17.5	66.6	41	9	25.6	21	M20x1.5	38.7
62	62	29	24	36	3	44	18	80.6	50	11	30.6	25	M24x1.5	52
72	72	29	24	36	3	44	18	80.6	50	11	30.6	25	M24x1.5	52
80	80	35	30	42	3	50	27	100.5	63.5	15	37	32	M30x1.5	68
85	85	35	30	42	3	50	27	100.5	63.5	15	37	32	M30x1.5	68
90	90	35	30	42	3	50	27	100.5	63.5	15	37	32	M30x1.5	68

1) Cam follower designation

- GC.. Concentric cam followers with convex outer ring
- GCL.. Concentric cam followers with cylindrical outer ring
- GCR.. Eccentric cam followers with convex outer ring
- GCRL.. Eccentric cam followers with cylindrical outer ring
- Without suffix: without seals
- Suffix ..EE: with plastic seals
- Suffix ..EEM: with metallic shields



Needle cam followers GC..

head side view

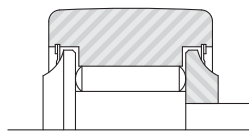

GC..EE, GC..EEM

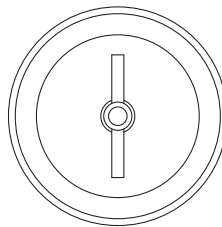

up to diameter D=28

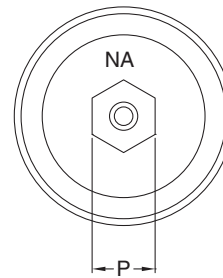

from diameter D=30

C ₁ mm	r _{min.} mm	P mm	d ₄ mm	S ⁶⁾		Clamping torque Nm	Basic capacities KN					Speed limits grease lubrication min ⁻¹	Weight with nut and washer kg	Ø outer D mm
				min.	max.		as a bearing		as a follower					
							Dyn. C	Stat. C ₀	Dyn. C _w	Dyn. F _r	Stat. F _{or}			
0.6	0.3		4	8.5	10	3	5.66	6.51	4.19	2.79	5.02	5700	0.024	16
0.6	0.3		4	10.5	13	8	6.44	8.15	4.65	3	6.28	4400	0.039	19
0.6	0.3		4	11.5	14	20	7.3	10.2	5.05	4.07	7.33	3500	0.057	22
0.6	0.3		4	11.5	14	20	7.3	10.2	5.45	5.42	8.63	3500	0.072	24
0.6	0.3		4	11.5	14	20	9.92	12.9	7.09	5.43	9.77	3200	0.080	26
0.6	0.3		4	11.5	14	20	9.92	12.9	7.57	6.95	11.4	3200	0.088	28
0.6	0.6	8	4	11.5	14.5	26	15.5	20.4	11.2	8.48	15.3	2900	0.118	30
0.6	0.6	8	4	11.5	14.5	26	15.5	20.4	11.8	10.6	18.1	2900	0.126	32
0.8	0.6	10	6	14.5	19	64	23.6	33.1	15.7	10.8	19.4	2200	0.220	35
0.8	1	12	6	16.5	22	90	29.9	48	18.5	13.8	24.8	1800	0.321	40
0.8	1	14	6	18	25	120	36.5	65.5	22.5	20.2	36.4	1400	0.500	47
0.8	1	14	6	18	25	120	36.5	65.5	25.2	28	47.5	1400	0.568	52
0.8	1	12	6	18.5	25.5	220	43.3	85.6	30.5	42.9	64.7	1200	1.035	62
0.8	1	12	6	18.5	25.5	220	43.3	85.6	33.9	65.8	79.5	1200	1.278	72
1	1	14	8	27.5	36	450	65.1	144	42.7	62.9	95.3	870	2.074	80
1	1	14	8	27.5	36	450	65.1	144	45.1	75.3	106	870	2.235	85
1	1	14	8	27.5	36	450	65.1	144	47.1	88.8	115	870	2.435	90

2) Hole diameter for mounting the concentric follower: d H7

Hole diameter for mounting the eccentric follower: d₁ H7

3) Dimension of the stud with eccentric bushing

4) Minimum recommended abutment diameter in case of axial loads or vibrations

5) On request cam followers can be produced with screw driver slot on the end of the threaded stud (suffix **AK**)

6) Mounting plate thickness

7) For concentric rollers only (without eccentric bushing)



Roller cam followers GCU..

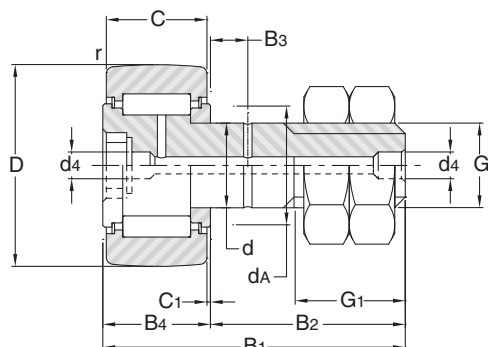

GCU..

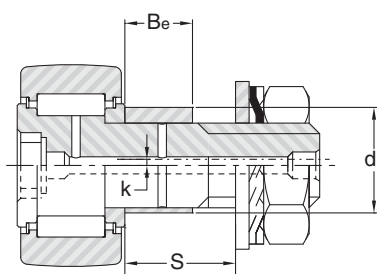

from GCUR35.. to GCUR52..

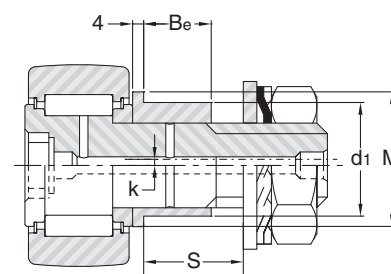

from GCUR62.. to GCUR130..

Ø outer D mm	Designation 1)	C mm	d 2)	d ₁ 2) 3)	k 3)	M 3)	B _e 3)	B ₁	B ₂	B ₃ 7)	B ₄	G ₁	Thread G mm	d _A 4)
	GCUR GCUR...M M													
35	35	18	16	21	1.5		14	52.5	32.8	8	19.7	17	M16x1.5	26
40	40	20	18	24	1.5		16	58.5	36.8	8	21.7	19	M18x1.5	28.6
47	47	24	20	27	2		17.5	66.5	40.8	9	25.7	21	M20x1.5	33.6
52	52	24	20	27	2		17.5	66.5	40.8	9	25.7	21	M20x1.5	33.6
62	62	29	24	36	3	44	18	80.5	49.8	11	30.7	25	M24x1.5	38.9
72	72	29	24	36	3	44	18	80.5	49.8	11	30.7	25	M24x1.5	38.9
80	80	35	30	42	3	50	27	100.5	63.3	15	37.2	32	M30x1.5	51.8
85	85	35	30	42	3	50	27	100.5	63.3	15	37.2	32	M30x1.5	51.8
90	90	35	30	42	3	50	27	100.5	63.3	15	37.2	32	M30x1.5	51.8
100	100	40	36	48	3	56	32	117.5	75.3	20	42.2	38	M36x3	61
110	110	40	36	48	3	56	32	117.5	75.3	20	42.2	38	M36x3	61
120	120	46	42	54	3	62	39	136.5	88.3	24	48.2	44	M42x3	71
130	130	46	42	54	3	62	39	136.5	88.3	24	48.2	44	M42x3	71

1) Cam followers designation

GCU.. Concentric cam follower with convex outer ring

GCUL.. Concentric cam follower with cylindrical outer ring

GCUR.. Eccentric cam follower with convex outer ring

GCURL.. Eccentric cam follower with cylindrical outer ring

Without suffix: without seals

Suffix **..MM**: with metallic shields



head side view

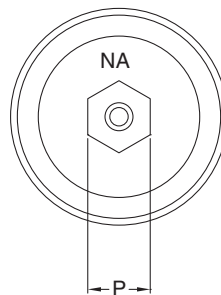

C ₁ mm	r min. mm	P mm	d ₄ mm	S ⁶⁾		Clamping torque Nm	Basic capacities KN					Speed limits grease lubrication min ⁻¹	Weight with nut and washer kg	Ø outer D mm
				min.	max.		as a bearing		as a follower					
							Dyn. C	Stat. C _o	Dyn. C _w	Dyn. Fr	Stat. For			
0.85	0.6	10	6	14.5	19	64	26.4	32.4	15.4	7.25	13.1	2200	0.215	35
0.85	1	12	6	16.5	22	90	26.4	32.4	18.7	12.1	21.8	2200	0.313	40
0.85	1	14	6	18	25	120	43.8	57.9	30.6	21.2	38.2	1600	0.500	47
0.85	1	14	6	18	25	120	43.8	57.9	30.6	21.2	38.2	1600	0.555	52
0.85	1	12	6	18.5	25.5	220	63.7	87.4	44.1	30.9	55.6	1400	1.035	62
0.85	1.1	12	6	18.5	25.5	220	63.7	87.4	50.8	52.7	84.1	1400	1.278	72
1.1	1.1	14	8	27.5	36	450	100	140	66.8	43.8	78.8	1000	2.070	80
1.1	1.1	14	8	27.5	36	450	100	140	75.8	68.1	122	1000	2.230	85
1.1	1.1	14	8	27.5	36	450	100	140	75.8	68.1	122	1000	2.470	90
1.1	2	17	8	32.5	41	740	115	175	82.1	76.6	135	840	3.380	100
1.1	2	17	8	32.5	41	740	115	175	89.7	107	161	840	3.860	110
1.1	2	19	8	39.5	48	1200	167	240	124	107	193	740	5.100	120
1.1	2	19	8	39.5	48	1200	167	240	133	142	228	740	5.590	130

- 2) Hole diameter for mounting the concentric follower: d H7
Hole diameter for mounting the eccentric follower: d₁ H7
- 3) Dimension of the stud with eccentric bushing
- 4) Minimum recommended abutment diameter in case of axial loads or vibrations
- 5) On request cam followers can be produced with screw driver slot on the end of the threaded stud (suffix **AK**)
- 6) Mounting plate thickness
- 7) For concentric rollers only (without eccentric bushing)



Roller cam followers NUKR..2SK

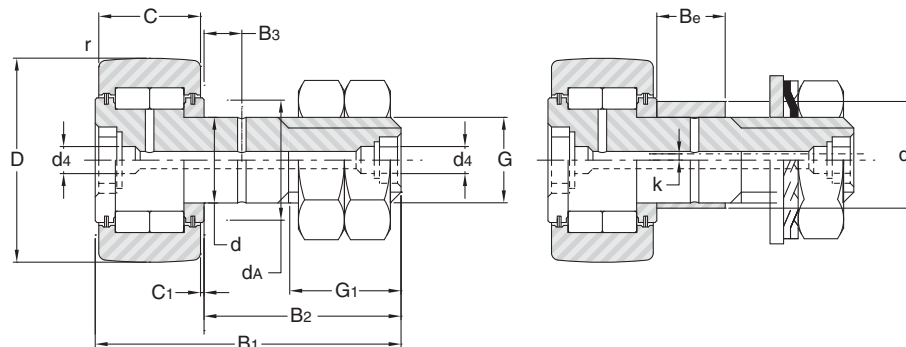

NUKR..2SK

NUKRE35..2SK

Ø outer D mm	Designation 1)	C mm	d 2) mm	d ₁ 2) 3) mm	k 3) mm	M 3) mm	B _e 3) mm	B ₁ mm	B ₂ mm	B ₃ mm	G ₁ mm	d ₃ mm	Thread G mm	d _A 4) mm
	NUKR..2SK NUKRE..2SK													
35	35	18	16	20	1	-	14	52	32.5	8	17	3	M16x1.5	23,6
40	40	20	18	22	1	-	16	58	36.5	8	19	3	M18x1.5	26,4
47	47	24	20	24	1	-	18	66	40.5	9	21	4	M20x1.5	31
52	52	24	20	24	1	-	18	66	40.5	9	21	4	M20x1.5	36,4
62	62	29	24	28	1	44	22	80	49.5	11	25	4	M24x1.5	44,4
72	72	29	24	28	1	44	22	80	49.5	11	25	4	M24x1.5	50,4
80	80	35	30	35	1.5	50	29	100	63	15	32	4	M30x1.5	52,9
90	90	35	30	35	1.5	50	29	100	63	15	32	4	M30x1.5	52,9

1) Designation for cam followers

NUKR..2SK Concentric cam follower with profiled outer ring

NUKRE..2SK Eccentric cam follower with profiled outer ring

2) Hole diameter for mounting the concentric follower: d H7

Hole diameter for mounting the eccentric follower: d1 H7

3) Dimension of the stud with eccentric bushing

4) Minimum recommended abutment diameter in case of axial loads or vibrations

5) For concentric rollers only (without eccentric bushing)



Roller cam followers NUKR..2SK

head side view

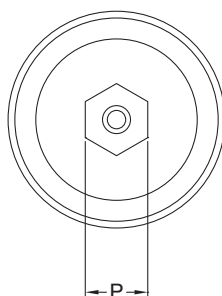

C ₁ mm	r min. mm	P mm	d ₄ mm	Clamping torque Nm ⁴⁾	Basic capacities kN					Speed limits grease lubrication min ⁻¹	Weight with nut and washer kg	∅ outer D mm
					as a bearing		as a follower					
					Dyn. C	Stat. C ₀	Dyn. C _w	Dyn. F _r	Stat. F _{0r}			
0.8	0.6	8	6	53.2	24.7	29.4	16.2	10.1	16.1	2300	0.215	35
0.8	1	8	6	77.5	26.6	33.3	18.7	15.0	23.9	2000	0.310	40
0.8	1	10	6	109	41.4	53.2	28.1	20.5	32.7	1700	0.500	47
0.8	1	10	6	109	45.8	63.1	29.6	22.2	35.4	1400	0.580	52
0.8	1	14	8	193	62.7	83.1	40.9	29.6	47.2	1200	1.050	62
0.8	1.1	14	8	193	68.9	97.8	46.1	39.6	63.1	1100	1.280	72
1.0	1.1	14	8	390	95.4	130	69.7	63.2	101	1000	2.080	80
1.0	1.1	14	8	390	95.4	130	77.8	97.8	128	1000	2.400	90



Small needle cam follower FP

FP, FPL series
without seals

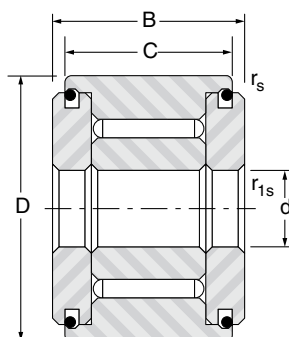

FP, FPL

Ø outer D mm	Designation 1)	D mm	d mm	B mm	C mm	r _s min. mm	r _{1s} min. mm	Basic capacities kN					Speed limits grease lubrication min ⁻¹	Weight kg
								as a bearing		as a cam follower				
	FP, FPL							Dyn. C	Stat. C _o	Dyn. C _w	Dyn. F _r	Stat. F _{or}		
10	3 10	10	3	8.7	8	0.2	0.15	2.8	3.09	2.12	1.43	2.58	8500	0.004
11	3 11	11	3	8.7	8	0.2	0.15	2.8	3.09	2.12	1.43	2.58	8500	0.005
12	4 12	12	4	9.7	9	0.2	0.15	3.74	4.74	2.54	1.63	2.94	6600	0.006
13	4 13	13	4	9.7	9	0.2	0.15	3.74	4.74	2.16	2.75	3.89	6600	0.008
14	4 14	14	4	10.2	9	0.3	0.15	4.05	5.44	2.86	2.26	4.07	5700	0.010
15	4 15	15	4	10.2	9	0.3	0.15	4.05	5.44	3.04	2.83	4.65	5700	0.011

1) Designation

FP Convex outer ring

FPL Cylindrical outer ring



Needle cam follower FG

FG series
without seal
FG..EE series
with plastic seals
FG..EEM series
with metallic
shields

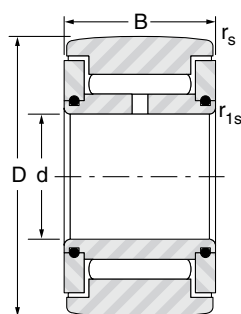

FG, FGL

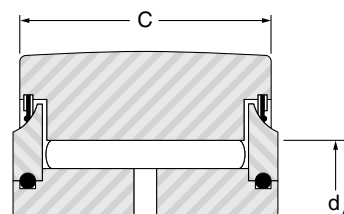

FG..EE, FG..EEM
FGL..EE, FGL..EEM

∅ outer D mm	Designation ¹⁾ FG, FGL	D mm	d mm	B mm	C mm	d _A ²⁾ mm	r _s min. mm	r _{1s} min. mm	Basic capacities kN					Speed limits grease lubrication min ⁻¹	Weight kg
									as a bearing		as a follower				
									Dyn. C	Stat. C ₀	Dyn. C _w	Dyn. F _r	Stat. F _{or}		
16	5 16	16	5	12	11	10	0.3	0.3	5.66	6.51	4.19	2.79	5.02	5700	0.016
19	6 19	19	6	12	11	12	0.3	0.3	6.44	8.15	4.65	3.49	6.28	4400	0.019
24	8 24	24	8	13	12	14.5	0.3	0.3	7.3	10.2	5.45	5.42	8.63	3500	0.037
	8 24 15	24	8	15	14	14.5	0.3	0.3	9.08	13.5	6.76	7.05	11.4	3500	0.044
30	10 30	30	10	15	14	19.5	0.6	0.3	14.2	18.3	10.3	7.67	13.8	2900	0.066
32	12 32	32	12	15	14	21.5	0.6	0.3	15.5	21.2	10.5	7.52	13.5	2400	0.077
35	15 35	35	15	19	18	24	0.6	0.3	22.5	35.4	14.6	11.6	20.9	2100	0.103
40	17 40	40	17	21	20	28	0.6	0.3	29.9	48.0	18.5	13.8	24.8	1800	0.155
47	20 47	47	20	25	24	32.5	1.0	0.3	36.5	65.5	22.5	20.2	36.4	1400	0.295
52	25 52	52	25	25	24	37	1.0	0.3	39.7	76.4	23.1	22.6	40.3	1200	0.310
62	30 62	62	30	29	28	44	1.0	0.3	46.5	97.9	28.9	35.5	58.2	1100	0.490
72	35 72	72	35	29	28	50	1.0	0.6	50.0	113	31.4	45.6	68.4	920	0.670
80	40 80	80	40	32	30	56	1.0	0.6	62.1	155	38.3	63.7	90.6	810	0.890
85	45 85	85	45	32	30	62	1.0	0.6	65.7	173	38.4	67.2	91.1	720	0.970
90	50 90	90	50	32	30	69	1.0	0.6	69.7	194	37.8	74.3	88.7	640	1.04
100	55 100	100	55	36	34	75	1.5	0.6	85.0	233	45.2	87.9	103	570	1.35
110	60 110	110	60	36	34	82	1.5	0.6	88.6	251	48.9	99.6	119	530	1.65
120	65 120	120	65	42	40	90	1.5	0.6	103	310	58.1	131	154	490	2.35
125	70 125	125	70	42	40	92	1.5	0.6	106	332	58.7	142	157	460	2.50
130	75 130	130	75	42	40	96	1.5	0.6	110	354	59.2	155	159	440	2.65
140	80 140	140	80	48	46	105	2.0	1.0	140	455	72.4	202	189	390	3.40
150	85 150	150	85	48	46	112	2.0	1.0	146	490	75.3	227	203	370	4.00
160	90 160	160	90	54	52	120	2.0	1.0	168	603	85.7	299	244	340	5.30
170	95 170	170	95	54	52	125	2.0	1.0	172	629	89.8	308	267	330	6.00
180	100 180	180	100	65	63	135	2.0	1.5	238	828	126	358	363	310	8.05
200	110 200	200	110	65	63	150	2.0	1.5	252	922	133	427	401	280	10.00
215	120 215	215	120	65	63	160	2.0	1.5	261	985	138	476	430	260	11.50
270	150 270	270	150	78	75	195	3.0	1.5	372	1470	200	721	658	210	22.00

1) Designation

FG..EE series with plastic seals are available up to type **FG 50 90**

FG convex outer ring

FGL cylindrical outer ring

2) Minimum recommended abutment diameter in case of axial loads or vibrations



Full complement roller cam followers FGU

Light series
 FGU.. without seals
 FGU..MM with metallic
 shield

FGU, FGUL

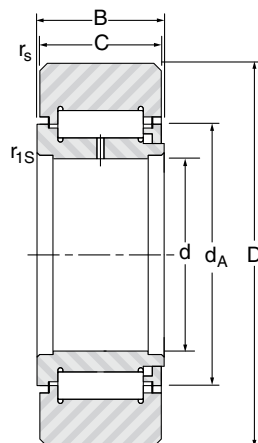

Ø outer D mm	Designation ¹⁾ FGU, FGUL light series	D mm	d mm	C mm	B mm	d _A ²⁾ mm	r _s min. mm	r _{1s} min. mm	Basic capacities kN			Speed limits grease lubrication min ⁻¹	Weight kg
									Dynamic		Static		
									C	Fr	For		
35	15 35	35	15	18	19	20.4	0.6	0.3	7.80	17.0	17.0	5700	0.096
40	17 40	40	17	20	21	23	0.6	0.3	11.5	20.0	21.5	5200	0.142
47	20 47	47	20	24	25	27.1	1.0	0.3	15.5	29.5	32.3	4400	0.235
52	25 52	52	25	24	25	31.8	1.0	0.3	17.3	31.5	36.0	3800	0.268
62	30 62	62	30	28	29	38.2	1.0	0.3	24.5	44.5	54.00	3200	0.454
72	35 72	72	35	28	29	45.9	1.0	0.6	31.3	50.0	66.0	2700	0.611
80	40 80	80	40	30	32	51.6	1.0	0.6	40.6	59.0	84.0	2400	0.822
110	60 110	110	60	34	36	71.2	1.5	0.6	64.0	88.0	129	1800	1.625
120	65 120	120	65	40	42	76.4	1.5	0.6	89.0	110	174	1700	2.300
125	70 125	125	70	40	42	81.5	1.5	0.6	93.0	110	180	1600	2.070
140	80 140	140	80	46	48	91.7	2.0	1.0	130	138	250	1400	3.450
160	90 160	160	90	52	54	101.8	2.0	1.0	166	188	327	1300	5.185
170	95 170	170	95	52	54	108.2	2.0	1.0	184	198	356	1200	5.925
200	110 200	200	110	63	65	124.1	2.0	1.5	310	280	590	1100	10.200
215	120 215	215	120	63	65	133.6	2.0	1.5	310	310	600	960	11.560

1) Designation

FGU convex outer ring

FGUL cylindrical outer ring

2) Minimum recommended abutment diameter in case of axial loads or vibrations



Full complement roller cam followers FGU

Heavy series

FGU.. without seals

FGU..MM with metallic shields

FGU, FGUL

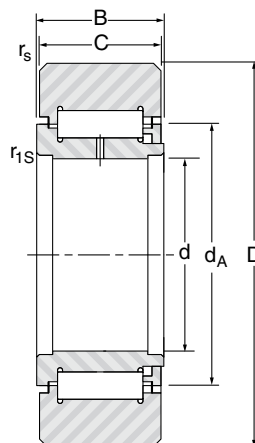

Ø outer D mm	Designation ¹⁾ FGU, FGUL heavy series	D mm	d mm	C mm	B mm	d _A ²⁾ mm	r _s min. mm	r _{1s} min. mm	Basic capacities kN					Speed limits grease lubrication min ⁻¹	Weight kg
									as a bearing		as a follower				
									Dyn. C	Stat. C ₀	Dyn. C _w	Dyn. F _r	Stat. F _{0r}		
42	15 42	42	15	18	19	20.4	1.0	0.3	26.4	32.4	19.7	14.7	26.4	2200	0.153
47	17 47	47	17	20	21	23	1.0	0.3	28.3	36.5	21.5	18.8	31.9	1900	0.214
52	20 52	52	20	24	25	27.1	1.0	0.3	43.8	57.9	30.7	21.3	38.3	1600	0.268
62	25 62	62	25	24	25	31.8	1.0	0.3	48.2	68.2	35.1	30.7	55.1	1400	0.435
72	30 72	72	30	28	29	38.2	1.0	0.3	70	103	49	40	72	1100	0.681
80	35 80	80	35	28	29	45.9	1.0	0.6	77.5	124	51	42.4	76.3	920	0.82
90	40 90	90	40	30	32	51.6	1.0	0.6	89.2	153	60.2	59.3	107	810	1.125
100	45 100	100	45	30	32	55.4	1.5	0.6	92.7	165	64.5	73.6	122	750	1.395
110	50 110	110	50	30	32	61.1	1.5	0.6	97.8	182	68.1	85.9	135	680	1.683
120	55 120	120	55	34	36	66.1	1.5	0.6	128	215	88.7	91.8	159	640	2.235
130	60 130	130	60	34	36	71.2	1.5	0.6	133	232	93.4	106	175	590	2.62
140	65 140	140	65	40	42	76.4	2.0	0.6	156	290	110	142	222	540	3.56
150	70 150	150	70	40	42	81.5	2.0	0.6	161	310	115	160	240	510	4.09
160	75 160	160	75	40	42	86.6	2.0	0.6	166	329	119	178	257	480	4.65
170	80 170	170	80	46	48	91.7	2.0	1.0	195	412	140	229	322	450	6.07
180	85 180	180	85	46	48	95.5	2.0	1.0	224	426	162	225	340	440	6.724
190	90 190	190	90	52	54	101.8	2.0	1.0	259	524	186	277	412	410	8.515
260	120 260	260	120	63	65	133.6	3.0	1.5	396	875	293	540	730	300	19.750
300	140 300	300	140	75	78	152.6	3.0	1.5	493	1210	367	818	1020	260	31.265

1) Designation

FGU convex outer ring

FGUL cylindrical outer ring

2) Minimum recommended abutment diameter in case of axial loads or vibrations



Cam followers without inner ring RNA

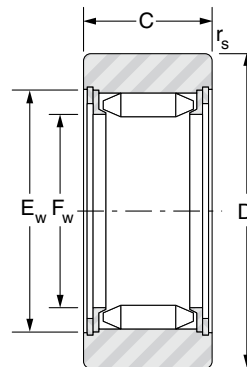

RNA...B6

Ø outer D mm	Designation ¹⁾			D ³⁾ mm	C mm	F _w mm	E _w mm	r _s min. mm	Basic capacities KN ²⁾				
	RNA B6	RNA B	RNAL						as a bearing		as a follower		
									Dyn. C	Stat. Co	Dyn. C _w	Dyn. Fr	Stat. For
19	RNA 11005 B6	RNAB 11005		19	12	7.3	12.3	0.35	5.31	4.44	4.82	4.44	4.82
22	RNA 11007 B6	RNAB 11007	RNAL 11007	22	12	9.7	14.7	0.35	6.42	5.93	5.5	5.26	6.55
28	RNA 11009 B6	RNAB 11009	RNAL 11009	28	12	12.1	17.1	0.35	7.37	7.42	6.66	7.42	9.06
32	RNA 11012 B6	RNAB 11012	RNAL 11012	32	15	17.6	22.6	0.35	12.7	16.4	9.38	9.48	13.7
35	RNA 11015 B6	RNAB 11015		35	15	20.8	25.8	0.65	13.9	19.4	9.60	9.47	14.1
42	RNA 11017 B6	RNAB 11017	RNAL 11017	42	15	23.9	28.9	0.65	15.0	22.4	11.0	14.4	18.4
47	RNA 11020 B6	RNAB 11020	RNAL 11020	47	18	28.7	34.7	0.65	21.7	33.5	14.6	16.0	23.3
52	RNA 11025 B6	RNAB 11025		52	18	33.5	39.5	0.65	23.6	39.1	15.0	17.1	24.4
62	RNA 11030 B6	RNAB 11030		62	22	38.2	44.2	0.65	34.2	65.8	22.6	32.8	44.3
72	RNA 11035 B6			72	22	44.0	50.0	0.65	36.7	75.7	24.6	42.4	52.2
90	RNA 11050 B6			90	24	62.1	68.1	0.85	44.0	107	25.8	53.1	57.0

1) Designation

RNA..B6 Convex outer ring with maximum inclination 0.15%

RNAB Convex outer ring with maximum inclination 1,5%

RNAL Cylindrical outer ring

2) Basic capacities refer to RNAL type only when mounted forced in a housing

3) Tolerances on dimension D: h9 for RNA..B6 and RNAB, h7 for RNAL



Inner ring BIC

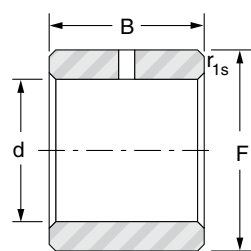

BIC

Speed limits grease lubrication min ⁻¹	Weight kg	Shaft d mm	Designation	F mm	B mm	F _w mm	D mm	r _{1s} min. mm	∅ outer D mm
			BIC						
6500	0.019								19
4700	0.022								22
3700	0.028								28
2400	0.032	12	BIC 1012	17.6	15	12	0.35	0.35	32
2000	0.035	15	BIC 1015	20.8	15	15	0.65	0.65	35
1700	0.042	17	BIC 1017	23.9	15	17	0.68	0.65	42
1400	0.047	20	BIC 2020	28.7	18	20	0.65	0.65	47
1200	0.052	25	BIC 1025	33.5	18	25	0.65	0.65	52
1100	0.062	30	BIC 2030	38.2	22	30	0.65	0.65	62
920	0.072	35	BIC 2035	44	22	35	0.65	0.65	72
640	0.090	50	BIC 11050	62.1	24	50	0.85	0.85	90



Full complement roller cam follower NUTR

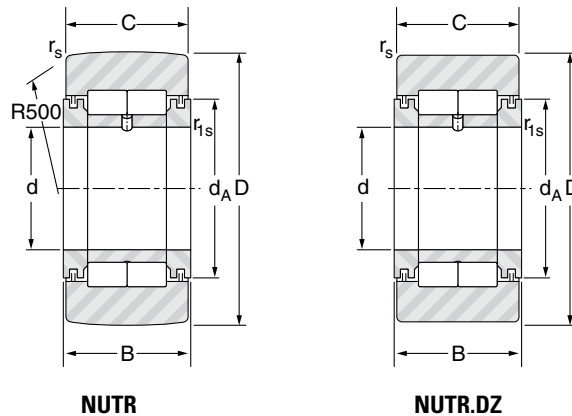

Ø outer D mm	Designation ¹⁾ NUTR, NUTR.DZ	D mm	d mm	B mm	C mm	d _A mm	r _s min. mm	r _{1s} min. mm	Basic capacities kN					Speed limits grease lubrication min ⁻¹	Weight kg
									as a bearing		as a follower				
	Dyn. C								Stat. C ₀	Dyn. C _w	Dyn. F _r	Stat. F _{or}			
35	15	35	15	19	18	24	0.6	0.3	24.7	29.3	16.2	10.1	16.1	6100	0.105
40	17	40	17	21	20	27	1.0	0.3	26.6	33.4	18.7	15.0	23.9	5300	0.154
42	1542	42	15	19	18	24	0.6	0.3	22.8	29.4	20.0	21.2	28.4	6100	0.166
47	1747	47	17	21	20	27	1.0	0.3	24.5	33.3	22.0	28.1	33.6	5300	0.230
	20	47	20	25	24	32	1.0	0.3	39.0	53.2	28.1	20.5	32.7	4500	0.254
52	2052	52	20	25	24	32	1.0	0.3	39.0	53.2	31.6	31.0	45.9	4500	0.326
	25	52	25	25	24	37	1.0	0.3	43.0	63.1	29.6	22.2	35.4	3700	0.291
62	2562	62	25	25	24	37	1.0	0.3	43.0	63.1	36.0	43.9	57.8	3700	0.460
	30	62	30	29	28	44	1.0	0.3	60.0	83.1	40.8	29.0	46.2	3200	0.480
72	3072	72	30	29	28	44	1.0	0.3	60.0	83.1	48.6	53.2	74.2	3200	0.711
	35	72	35	29	28	50	1.1	0.6	65.5	97.8	45.9	38.7	61.7	2600	0.655
80	3580	80	35	29	28	50	1.1	0.6	65.5	97.8	51.7	58.7	81.9	2600	0.865
	40	80	40	32	30	55	1.1	0.6	88.0	132	60.6	48.0	76.5	2500	0.848
85	45	85	45	32	30	60	1.1	0.6	93.0	146	62.0	50.2	80.0	2200	0.917
90	4090	90	40	32	30	55	1.1	0.6	88.0	132	69.1	75.4	111	2500	1.162
	50	90	50	32	30	65	1.1	0.6	98.0	160	63.3	52.9	84.3	2000	0.988
100	45100	100	45	32	30	60	1.1	0.6	93.0	146	74.3	92.2	127	2200	1.412
110	50110	110	50	32	30	65	1.1	0.6	98.0	160	79.0	110	141	2000	1.727

1) Designation

NUTR Convex outer ring

NUTR.DZ Cylindrical outer ring

