



A

TORNEADO GENERAL Piezas de repuesto, mecanizado interior

**CoroTurn® RC diseño de sujeción rígida**

B

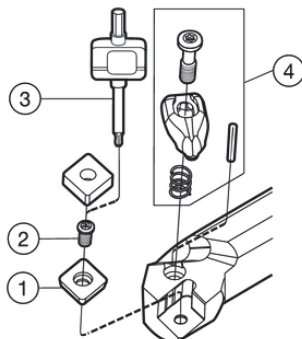

C

Portaplaquitas con		Coromant Capto	1	2	3	4 <sup>1)2)</sup>	
Pulgadas	Métrica		Placa de apoyo (para plaquita de grosor mm/pulgadas)	Tornillo de la placa de apoyo	Llave (Torx Plus)	Juego de sujeción completo	
 A12S-DCLNR/L 3 A16T-DCLNR/L 3 A20T-DCLNR/L 3 A16T-DCLNR/L 4 A20T-DCLNR/L 4 A24T-DCLNR/L 4	A25T-DCLNR/L 09	C4-DCLNR/L-13080-09 C5-DCLNR/L-13080-09	5322 236-04 (3.18/.125)	5513 020-04	5680 051-03 (9IP)	5412 028-011	
	A25T-DCLNR/L 12 A32U-DCLNR/L 12	C4-DCLNR/L-17090-12 C5-DCLNR/L-17090-12 C6-DCLNR/L-17090-12	5322 236-03 (4.76/.187)	5513 020-02	5680 049-01 (15IP)	5412 028-021 5412 032-021 <sup>3)</sup> 5412 034-021 <sup>4)</sup>	
	A40V-DCLNR/L 12		5322 234-01 (4.76/.187) 5322 234-02 (7.94/.312) <sup>2)</sup>	5513 020-02	5680 049-01 (15IP)	5412 028-021 5412 032-021 <sup>3)</sup> 5412 034-021 <sup>4)</sup>	
	A24T-DCLNR/L 5 A32U-DCLNR/L 5 A40V-DCLNR/L 5	A50W-DCLNR/L 16	C6-DCLNR/L-27140-16	5322 234-03 (6.35/.250) 5322 234-04 (7.94/.312) <sup>2)</sup>	5513 020-07	5680 043-14 (20IP)	5412 028-031 5412 032-031 <sup>3)</sup> 5412 034-031 <sup>4)</sup>
 A12S-DDUNR/L 3 A16T-DDUNR/L 3 A20U-DDUNR/L 3 A16T-DDUNR/L 4 A20T-DDUNR/L 4 A24T-DDUNR/L 4 A32U-DDUNR/L 4 A40V-DDUNR/L 4	A25T-DDUNR/L 11 A32U-DDUNR/L 11	C4-DDUNR/L-17090-11 C5-DDUNR/L-17090-11	5322 267-01 (4.76/.187)	5513 020-04	5680 051-03 (9IP)	5412 028-011 <sup>1)</sup>	
	A40V-DDUNR/L 15 A50U-DDUNR/L 15	C4-DDUNR/L-27080-15 C5-DDUNR/L-27140-15 C6-DDUNR/L-27140-15	5322 266-02 (6.35/.250) 5322 266-01 (4.76/.187) <sup>2)5)</sup> 5322 266-03 (7.94/.312) <sup>2)</sup>	5513 020-02	5680 049-01 (15IP)	5412 028-021 5412 032-021 <sup>3)</sup> 5412 034-021 <sup>4)</sup>	
	A16T-DSKNR/L 4 A20T-DSKNR/L 4	A25T-DSKNR/L 09 A25T-DSKNR/L 12 A32U-DSKNR/L 12		5322 426-01 (3.18/.125) 5322 426-02 (4.76/.187)	5513 020-04 5513 020-02	5680 051-03 (9IP) 5680 049-01 (15IP)	5412 028-011 5412 028-021 5412 032-021 <sup>3)</sup> 5412 034-021 <sup>4)</sup>
	A24T-DSKNR/L 4	A40V-DSKNR/L 12		5322 425-01 (4.76/.187) 5322 425-02 (7.94/.312) <sup>2)</sup>	5513 020-02	5680 049-01 (15IP)	5412 028-021 5412 032-021 <sup>3)</sup> 5412 034-021 <sup>4)</sup>
 A12S-DTFNR/L 3 A16T-DTFNR/L 3 A20T-DTFNR/L 3 A24T-DTFNR/L 3 A24T-DTFNR/L 4 A32U-DTFNR/L 4	A25T-DTFNR/L 16 A32U-DTFNR/L 16 A40T-DTFNR/L 16	C4-DTFNR/L-17090-16 C5-DTFNR/L-17090-16	5322 316-01 (4.76/.187)	5513 020-04	5680 051-03 (9IP)	5412 028-011	
	A40V-DTFNR/L 22 A50W-DTFNR/L 22		5322 315-04 (4.76/.187)	5513 020-02	5680 049-01 (15IP)	5412 028-021 5412 032-021 <sup>3)</sup> 5412 034-021 <sup>4)</sup>	
	A16T-DWLNRL/L 3 A20T-DWLNRL/L 3	A25T-DWLNRL/L 06 A32T-DWLNRL/L 06 A40T-DWLNRL/L 06	C4-DWLNRL/L-13075-06	5322 328-01 (4.76/.187)	5513 020-04	5680 051-03(9IP)	5412 028-011
	A16T-DWLNRL/L 4 A20T-DWLNRL/L 4	A25T-DWLNRL/L 08 A32T-DWLNRL/L 08	C4-DWLNRL/L-17090-08 C5-DWLNRL/L-17090-08	5322 328-02 (4.76/.187)	5513 020-02	5680 049-01(15IP)	5412 028-021
A24T-DWLNRL/L 4 A32U-DWLNRL/L 4	A40T-DWLNRL/L 08 A50V-DWLNRL/L 08		5322 331-12 (4.76/.187)	5513 020-02	5680 049-01(15IP)	5412 028-021	
 A24T-DVUNR/L 3	A40T-DVUNR/L 16		5322 269-01 (4.76/.187)	5513 020-09	5680-049-01(15IP)	5412 028-061	



1) Para piezas para juego de sujeción, ver páginas A445.  
 2) Piezas opcionales suministradas en pedido separado  
 3) Juegos de sujeción para plaquitas cerámicas con agujero  
 4) Juegos de sujeción para plaquitas cerámicas sin agujero  
 5) Para plaquitas con radio de punta .016-.031



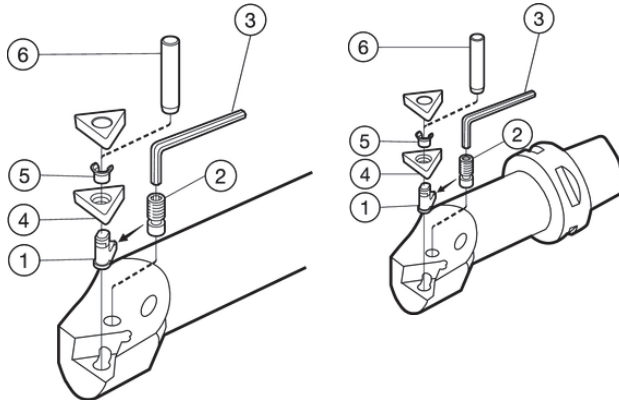

**Diseño de palanca T-Max P**



		1	2	3	4			5	6
Portaplaquitas con mango	Coromant Capto*	Palanca	Tornillo	Llave (mm)	Placa de apoyo	Para espesor de plaquita	Radio mm/pulgadas	Pasador de la placa de apoyo	Punzón de montaje
 A16R-PCLNR/L 09 A20S-PCLNR/L 09 A25T-PCLNR/L 09	C3-PCLNR/L- 13075-09	174.3-845-1	174.3-829	170.3-864 (1.98)	-	-	-	-	-
	C3-PCLNR/L- 17090-09								
	C4-PCLNR/L- 13080-09								
	C4-PCLNR/L- 17090-09								
	C5-PCLNR/L- 13080-09								
A25T-PCLNR/L 12	C3-PCLNR/L- 17090-12	438.3-841-1	438.3-832M	174.1-863 (2.5)	-	-	-	-	-
	C4-PCLNR/L- 17090-12								
	C5-PCLNR/L- 17090-12								
	C6-PCLNR/L- 17100-12								
A32T-PCLNR/L 12		174.3-848M	174.3-858	174.1-864 (3.0)	171.31-850M	4.76/.187	0.4-1.6/.016-.063	174.3-861	174.3-871
A40T-PCLNR/L 12	C3-PCLNR/L- 22064-12	174.3-841M	174.3-821	174.1-864 (3.0)	171.31-850M	4.76/.187	0.4-1.6/.016-.063	174.3-861	174.3-871
	C3-PCLNR/L- 22096-12								
	C4-PCLNR/L- 22110-12								
	C4-PCLNR/L- 27080-12								
	C4-PCLNR/L- 27120-12								
	C5-PCLNR/L- 22110-12								
	C5-PCLNR/L- 27140-12								
	C5-PCLNR/L- 35100-12								
	C6-PCLNR/L- 22110-12								
A50W-PCLNR/L 16	C5-PCLNR/L- 35150-16	438.3-840	438.3-831	174.1-864 (3.0)	171.31-852	6.35/.250	0.4-2.4/.016-.094	174.3-864	174.3-873
	C6-PCLNR/L- 27140-16								
	C6-PCLNR/L- 35175-16								
A50W-PCLNR/L 19		174.3-849M	174.3-822M	3021 010-040	171.31-851M	6.35/.250	0.4-2.4/.016-.094	174.3-868	174.3-872
 A25T-PDUNR/L 11 C4-PDUNR/L-17090-11 C5-PDUNR/L-17090-11 C6-PDUNR/L-17100-11	C3-PDUNR/L-17090-11	5432 015-021	438.3-830	174.1-870 (1.98)	-	-	-	-	-
	C4-PDUNR/L-17090-11								
	C5-PDUNR/L-17090-11								
	C6-PDUNR/L-17100-11								
A32T-PDUNR/L 11	C3-PDUNR/L-22064-11	5432 001-01	174.3-820M	174.1-863 (2.5)	5322 255-01	4.76/.187	0.4-0.8/.016-.031	174.3-860	174.3-870
	C3-PDUNR/L-22096-11				5322 255-02 <sup>1)</sup>	4.76/.187	1.2-1.6/.047-.063		
	C4-PDUNR/L-22110-11								
	C5-PDUNR/L-22110-11								

1) Piezas opcionales suministradas en pedido separado





**A**



TORNEADO GENERAL Piezas de repuesto, mecanizado interior

**Diseño de palanca T-Max P**

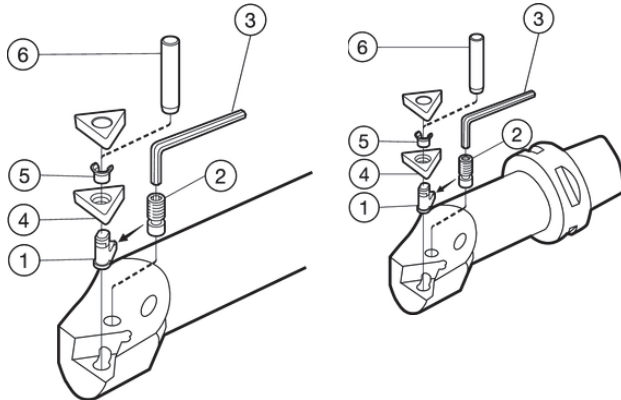
**B**



**C**

		1	2	3	4	5	6				
Portaplaquitas con mango	Coromant Capto®	Palanca	Tornillo	Llave (mm)	Placa de apoyo	Para espesor de plaquita	Radio mm/pulgadas	Pasador de la placa de apoyo	Punzón de montaje		
	A40T-PDUNR/L 15 A50U-PDUNR/L 15	174.3-847M	174.3-830	174.1-864 (3.0)	171.35-851M 171.35-850M <sup>1)</sup> 171.35-856 <sup>1)</sup> 171.35-855 <sup>1)</sup>	6.35/.250 6.35/.250 4.76/.187 4.76/.187	0.4-0.8/.016-.031 1.2-1.6/.047-.063 0.4-0.8/.016-.031 1.2-1.6/.047-.063	174.3-861	174.3-871		
<b>G</b>	C4-PDUNR/L-27080-15 C4-PDUNR/L-27120-15 C5-PDUNR/L-27140-15 C5-PDUNR/L-35100-15 C6-PDUNR/L-22110-15 C6-PDUNR/L-27140-15 C6-PDUNR/L-35175-15	174.3-847M	174.3-830	174.1-864 (3.0)	171.35-851M 171.35-850M <sup>1)</sup> 171.35-856 <sup>1)</sup> 171.35-855 <sup>1)</sup>	6.35/.250 6.35/.250 <sup>1)</sup> 4.76/.187 <sup>1)</sup> 4.76/.187 <sup>1)</sup>	0.4-0.8/.016-.031 1.2-1.6/.047-.063 0.4-0.8/.016-.031 1.2-1.6/.047-.063	174.3-861	174.3-871		
		A25T-PSKNR/L 12 C3-PSKNR/L-17090-12 C4-PSKNR/L-17090-12 C5-PSKNR/L-17090-12	438.3-841-1	438.3-832M	174.1-863 (2.5)	- 174.3-851M 174.3-856	- 4.76/.187 4.76/.187 <sup>1)</sup>	- 0.4-1.2/.016-.047 1.2-1.6/.047-.063	- 174.3-861	- 174.3-871	
		<b>H</b>	A32T-PSKNR/L 12	174.3-848M	174.3-858	174.1-864 (3.0)	174.3-851M 174.3-856	4.76/.187 4.76/.187	0.4-1.2/.016-.047 1.2-1.6/.047-.063	174.3-861	174.3-871
			A40T-PSKNR/L 12 C3-PSKNR/L-22064-12 C3-PSKNR/L-22096-12 C4-PSKNR/L-22110-12 C4-PSKNR/L-27080-12 C4-PSKNR/L-27120-12 C5-PSKNR/L-22110-12 C5-PSKNR/L-27140-12 C6-PSKNR/L-22110-12	174.3-841M	174.3-821	174.1-864 (3.0)	174.3-851M 174.3-856	4.76/.187 4.76/.187	0.4-1.2/.016-.047 1.2-1.6/.047-.063	174.3-861	174.3-871
	<b>I</b>	C5-PSKNR/L-35100-15 C5-PSKNR/L-35150-15 C6-PSKNR/L-27140-15 C6-PSKNR/L-35175-15	438.3-840	438.3-831	174.1-864 (3.0)	174.3-857	6.35/.250	0.4-1.6/.016-.063	174.3-864	174.3-873	
		A50U-PSKNR/L 19	174.3-849M	174.3-822M	3021 010-040 (4.0)	171.31-851M	4.76/.187	0.4-1.2/.016-.047	174.3-868	5681 002-02	
			A16R-PTFNR/L 11 C3-PTFNR/L-13075-11 A20S-PTFNR/L 11 C4-PTFNR/L-13080-11 A25T-PTFNR/L 11 C5-PTFNR/L-13080-11	174.3-846-1	174.3-829	170.3-864 (1.98)	-	-	-	-	-
1) Piezas opcionales suministradas en pedido separado											

**J**

A 478







TURN - SPA

Piezas de repuesto, mecanizado interior TORNEADO GENERAL

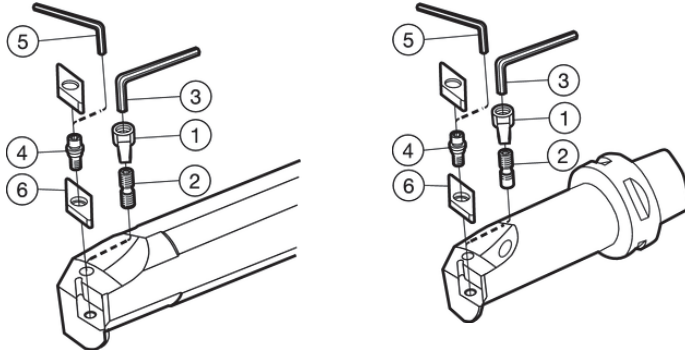
**Diseño de sujeción superior con excéntrica y brida superior T-Max P**



	1	2	3	4	5	6			
Portaplaquitas con mango									
Coromant Capto®									
	Amarre	Tornillo de sujeción	Llave (mm)	Pasador de blocaje	Llave (mm)	Placa de apoyo	Para espesor de plaquita	Radio	mm/pulgadas
 S40V-MVUNR/L 16	MC-12	MS-510	3021 011-532 (3.96)	MN-34L	174.1-870 (1.98)	MVN-322	4.76/.187	0.4-1.2/.016-.047	
C4-MVUNR/L-27120-16									
C5-MVUNR/L-27140-16									
C5-MVUNR/L-35150-16									
C6-MVUNL-22120-16									
C6-MVUNR-35175-16									



A 479



A

TORNEADO GENERAL Piezas de repuesto, mecanizado interior

TURN - SPA

**Diseño con cuña T-Max P**

B

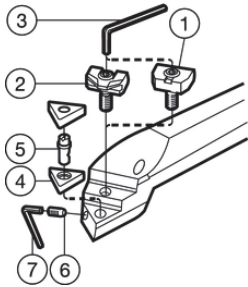

C

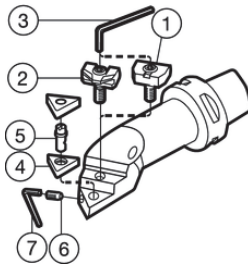

G

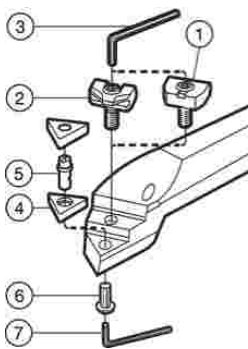

H

Herramientas con			1	2	3
Pulgadas	Métrica	Coromant Capto*	Juego de cuña	Juego de brida-cuña	Llave (mm)
▲	S25T-PTFNR/L 16-W	C3-PTFNR/L-17090-16-W C4-PTFNR/L-17090-16-W C5-PTFNR/L-17090-16-W	170.38-823-2	-	174.1-864 (3.0)
	S32U-PTFNR/L 16-W S40V-PTFNR/L 16-W	C3-PTFNR/L-22096-16-W C4-PTFNR/L-22110-16-W C4-PTFNR/L-27120-16-W C5-PTFNR/L-22110-16-W C5-PTFNR/L-27140-16-W C6-PTFNR/L-22110-16-W C6-PTFNR/L-27140-16-W	170.38-823-1 170.38-820-1 <sup>1)</sup>		174.1-864 (3.0) 174.1-863 (2.5) <sup>1)</sup>
			170.38-823-1 170.38-820-1 <sup>1)</sup>		174.1-864 (3.0) 174.1-863 (2.5) <sup>1)</sup>
▲ 80°	S40V-PTFNR/L 22-W S50W-PTFNR/L 22-W	C4-PTFNR/L-27120-22-W C5-PTFNR/L-35150-22-W C6-PTFNR/L-35175-22-W	170.38-824-1 170.38-821-1 <sup>1)</sup>		3021 010-040 (4.0) 174.1-864 (3.0) <sup>1)</sup>
		C5-PTFNR/L-27140-22-W C6-PTFNR/L-27140-22-W	170.38-824-1	-	3021 010-040 (4.0)
	S16T-MWLNRL 3 S20U-MWLNRL 3 S24V-MWLNRL 3	A20S-MWLNRL 06	-	5431 125-011	170.3-860 (2.5)
G		C3-MWLNRL/L-13075-06 C3-MWLNRL/L-17090-06M1 C4-MWLNRL/L-13075-06M C4-MWLNRL/L-17090-06M1	-	5431 125-011	170.3-860 (2.5)
	S32W-MWLNRL 3	A25T-MWLNRL/L 06 A32U-MWLNRL/L 06	-	5431 125-011	170.3-860 (2.5)
	S16T-MWLNRL 4 S20U-MWLNRL 4 S24V-MWLNRL 4 S32W-MWLNRL 4	A25T-MWLNRL/L 08 A25T-MWLNRL/L 08 A32U-MWLNRL/L 08 A40V-MWLNRL/L 08 A50W-MWLNRL/L 08	C4-MWLNRL/L-17090-08 C5-MWLNRL/L-17090-08 C4-MWLNRL/L-22110-08 C4-MWLNRL/L-27120-08 C5-MWLNRL/L-22110-08 C5-MWLNRL/L-27140-08	-	5431 125-021

<sup>1)</sup> Piezas opcionales suministradas en pedido separado

J





TURN - SPA

Piezas de repuesto, mecanizado interior TORNEADO GENERAL

**Diseño con cuña T-Max P**

4	5	6	7		
Placa de apoyo	Para espesor de plaquita	Radio mm/pulgadas	Pasador	Tornillo	Llave (mm/Torx Plus)
-	-	-	5313 021-01	5512 031-01	5680 051-03 (9IP)
170.3-852	4.76/.187	0.4-0.8/.016 - .031	5313 021-02	5512 031-01	5680 051-03 (9IP)
170.3-852	4.76/.187	0.4-0.8/.016 - .031	5313 021-02	3212 100-206	174.1-870 (1.98)
170.3-855	4.76/.187	1.2-1.6/.047 - .063	5313 021-03	5512 031-02	5680 049-02 (15IP)
170.3-856 <sup>1)</sup>	4.76/.187	0.4-0.8/.016 - .031			
170.3-855	4.76/.187	1.2-1.6/.047 - .063	5313 021-03	5512 031-02	5680 051-03 (9IP)
-	-	-	5313 022-02	-	170.3-864 (1.98)
5322 331-06	4.76/.187	0.4-0.8/.016 - .031	5313 022-01	5512 030-03	170.3-864 (1.98)
5322 331-11			5313 022-02	-	170.3-864 (1.98)
5322 331-11	4.76/.187	0.4-0.8/.016 - .031	5313 022-02	-	170.3-864 (1.98)
5322 331-06	4.76/.187	0.4-0.8/.016 - .031	5313 022-01	5512 030-03	170.3-864 (1.98)
5322 331-09	4.76/.187	0.4-0.8/.016 - .031	5313 022-03	-	-
5322 331-10 <sup>1)</sup>	4.76/.187	1.2-1.6/.047 - .063			
5322 331-07	4.76/.187	0.4-0.8/.016 - .031	5313 022-03	-	-
5322 331-08 <sup>1)</sup>	4.76/.187	1.2-1.6/.047 - .063			
5322 331-07	4.76/.187	0.4-0.8/.016 - .031	5313 022-03	5512 030-04	174.1-863 (2.5)
5322 331-08 <sup>1)</sup>	4.76/.187	1.2-1.6/.047 - .063			

A

B

C

G

H

I

J



A 481





A

TORNEADO GENERAL Piezas de repuesto, mecanizado interior

TURN - SPA

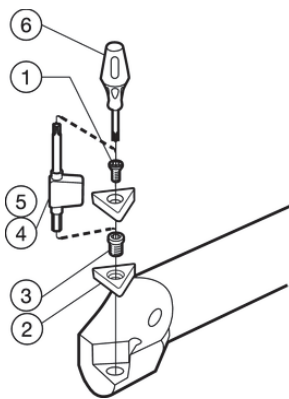
**Diseño de sujeción por tornillo CoroTurn® 107**



Portaplaquitas con mango			1
Pulgadas	Métrica	Coromant Capto®	Tornillo de plaquita (rosca)
 E05K-SCLCR/L 2-R	A08H-SCLCR/L 06 A10K-SCLCR/L 06 E08K-SCLCR/L 06-R A08H-SCLCR/L 06-R A10K-SCLCR/L 06-R E10M-SCLCR/L 06-R	-	5513 020-46 (M2.5)
	E06M-SCLCR/L-2 E08R-SCLCR/L-2 E10R-SCLCR/L-2 A06M-SCLCR/L-2 A08M-SCLCR/L-2 A06M-SCLCR/L 2-R A08M-SCLCR/L 2-R A10R-SCLCR/L 2-R A10R-SCLCR/L 2 E06M-SCLCR/L 2-R E08R-SCLCR/L 2-R E10R-SCLCR/L 2-R	E12Q-SCLCR/L 06-R E16R-SCLCR/L 06-R A12M-SCLCR/L 06 A16R-SCLCR/L 06 A12M-SCLCR/L 06-R A16R-SCLCR/L 06-R	-
A12S-SCLCR/L3 A10R-SCLCR/L-3 E12S-SCLCR/L-3 A10R-SCLCR/L 3-R A12S-SCLCR/L 3-R E12R-SCLCR/L 3-R	A16R-SCLCR/L 09 A20S-SCLCR/L 09 A16R-SCLCR/L 09-R A20S-SCLCR/L 09-R E16R-SCLCR/L 09-R E20S-SCLCR/L 09-R	C3-SCLCR/L-11065-09 C4-SCLCR/L-11070-09 C5-SCLCR/L-11070-09 C3-SCLCR/L-13075-09 C4-SCLCR/L-13080-09 C5-SCLCR/L-13080-09	5513 020-09 (M3.5)
E16T-SCLCR/L-3 A16T-SCLCR/L-3 E10R-SCLCR/L 3-R E16S-SCLCR/L 3-R	A25T-SCLCR/L 09 E25T-SCLCR/L 09-R	C3-SCLCR/L-17090-09 C4-SCLCR/L-17090-09 C5-SCLCR/L-17090-09	5513 020-10 (M3.5)
		C4-SCLCR/L-27080-09 C5-SCLCR/L-35100-09	5513 020-01 (M3.5)
A16T-SCLCR/L-4	A25T-SCLCR/L 12	C3-SCLCR/L-17090-12 C4-SCLCR/L-17090-12	5513 020-17 (M4x0.5)

1) Las piezas opcionales deben pedirse por separado.

C

G

H

I

J





TURN - SPA

Piezas de repuesto, mecanizado interior TORNEADO GENERAL

**Diseño de sujeción por tornillo CoroTurn® 107**

2	3	4/5	6 <sup>1)</sup>		
Placa de apoyo	Para espesor de plaquita	Radio mm/pulgadas	Tornillo de placa de apoyo (rosca)	Llave (Torx Plus/mm)	Destornillador (Torx Plus)
-	-	-	-	5680 051-02 (7IP)	
-	-	-	-	5680 051-02 (7IP)	5680 046-03 (7IP)
-	-	-	-	5680 049-01 (15IP/3.5)	5680 046-02 (15IP)
-	-	-	-	5680 049-01 (15IP/3.5)	5680 046-02 (15IP)
5322 232-01	3.97/.156	0.4-0.8/.016-.031	5512 090-01 (M5x0.5)	5680 049-01 (15IP/3.5)	5680 046-02 (15IP)
-	-	-	-	5680 049-02 (15IP/4.0)	5680 046-02 (15IP)

A

B

C

G

H

I

J



A 483







A

TORNEADO GENERAL Piezas de repuesto, mecanizado interior

TURN - SPA

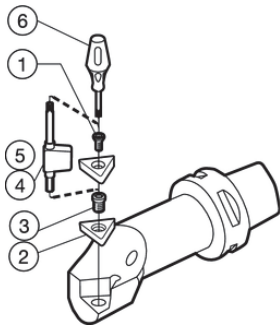
**Diseño de sujeción por tornillo CoroTurn® 107**



Portaplaquitas con mango												
Pulgadas	Métrica	Coromant Capto®	Tornillo de plaquita (rosca)									
 E06M-SDUCR/L-2 E08R-SDUCR/L-2C E10R-SDUCR/L-2C A06M-SDUCR/L-2 A08M-SDUCR/L-2 A20T-SDUCR/L 3 A08M-SDXCR/L 2 A10R-SDXCR/L 2 A06M-SDQCR/L 2 A08M-SDQCR/L 2 A10R-SDQCR/L 2 A06M-SDUCR/L 2-R A08M-SDUCR/L 2-R A10R-SDUCR/L 2R A12S-SDUCR/L 2-ERX A08M-SDXCR/L 2-R A10R-SDXCR/L 2R A06M-SDQCR/L 2-R A08M-SDQCR/L 2-R A10R-SDQCR/L 2-R A10K-SDXCR/L 2-R A10R-SDUCR/L 2 A12S-SDUCR/L 2-EX A16T-SDUCR/L 2-DX	A10K-SDUCR/L 07-ER A12M-SDUCR/L 07-ER E10M-SDUCR/L 07-ER E12Q-SDUCR/L 07-ER E16R-SDUCR/L 07-ER F10M-SDUCR/L 07-ER F12Q-SDUCR/L 07-ER A10K-SDUCR/L 07 A12M-SDUCR/L 07 A16R-SDUCR/L 07 A16R-SDUCR/L 07-EX A20S-SDUCR/L 07-EX A25T-SDUCR/L 07-DX A10K-SDQCR/L 07 A12M-SDQCR/L 07 A12M-SDXCR/L 07 A16R-SDUCR/L 07-ERX A20S-SDUCR/L 07-ERX A12M-SDXCR/L 07-R A16R-SDXCR/L 07-R A10K-SDQCR/L 07-R A12M-SDQCR/L 07-R A16R-SDQCR/L 07-R A16R-SDQCR/L 07 A16R-SDXCR/L 07	C3-SDUCR/L-11065-07 C4-SDUCR/L-11070-07 C5-SDUCR/L-11070-07 C3-SDUCR/L-13070-07X C3-SDUCR/L-15080-07X C4-SDUCR/L-13070-07X C4-SDUCR/L-15080-07X C4-SDUCR/L-18090-07X C5-SDUCR/L-15080-07X C5-SDUCR/L-18090-07X	1 5513 020-03 (M2.5)									
			E12S-SDUCR/L-3 A12S-SDUCR/L-3R A12S-SDXCR/L 3-R A12S-SDQCR/L 3 A12S-SDUCR/L 3 E12R-SDUCR/L 3-R A12S-SDQCR/L 3R	A20S-SDUCR/L 11 A20S-SDQCR/L 11-R A20S-SDQCR/L 11 A20S-SDXCR/L 11 E20S-SDUCR/L 11-R	-	5513 020-09 (M3.5)						
						E16T-SDUCR/L-3 A16T-SDUCR/L-3 E16S-SDUCR/L 3-R A12S-SDXCR/L 3 A16T-SDXCR/L 3	A25T-SDUCR/L 11 A25T-SDQCR/L 11 A25T-SDXCR/L 11 E25T-SDUCR/L 11-R	C3-SDUCR/L-13075-11 C3-SDUCR/L-17090-11 C4-SDUCR/L-13080-11 C5-SDUCR/L-13080-11 C4-SDUCR/L-17090-11 C5-SDUCR/L-17090-11	5513 020-10 (M3.5)			
									A20T-SDUCR/L-3 A20T-SDUCR/L-3X	A32T-SDUCR/L 11-X	C3-SDUCR/L-22064-11 C3-SDUCR/L-22096-11 C4-SDUCR/L-22110-11 C4-SDUCR/L-27080-11 C5-SDUCR/L-22110-11 C5-SDUCR/L-35100-11	5513 020-01 (M3.5)
												
						A25T-SSKCR/L 12	C5-SSKCR/L-17090-12 C3-SSKCR/L-22064-12 C4-SSKCR/L-22110-12 C5-SSKCR/L-22110-12	5513 020-17 (M4x0.5)				
								A32T-SSKCR/L 12	C4-SSKCR/L-27080-12 C5-SSKCR/L-35100-12	5513 020-18 (M4x0.5)		

1) Las piezas opcionales deben pedirse por separado.

J





TURN - SPA

Piezas de repuesto, mecanizado interior TORNEADO GENERAL

**Diseño de sujeción por tornillo CoroTurn® 107**

2	3	4/5	6 <sup>1)</sup>		
Placa de apoyo	Para espesor de plaquita	Radio mm/pulgadas	Tornillo de placa de apoyo (rosca)	Llave (Torx Plus/mm)	Destornillador (Torx Plus)
-	-	-	-	5680 051-02 (7IP)	5680 046-03 (7IP)
-	-	-	-	5680 049-01 (15IP/3.5)	5680 046-02 (15IP)
-	-	-	-	5680 049-01 (15IP/3.5)	5680 046-02 (15IP)
5322 263-01 5322 263-02 <sup>1)</sup>	3.97/.156 3.97/.156	0.4-0.8/.016-.031 1.2/.047	5512 090-01 (M5x0.5/3.5)	5680 049-01 (15IP/3.5)	5680 046-02 (15IP)
-	-	-	-	5680 049-01 (15IP/3.5)	416.1-864 (T15)
-	-	-	-	5680 049-01 (15IP/3.5)	416.1-864 (T15)
-	-	-	-	5680 049-02 (15IP/4.0)	416.1-864 (T15)
5322 420-02	4.76/.187	0.4-1.2/.016-.047	5512 090-03 (M6x0.75)	5680 049-02 (15IP/4.0)	416.1-864 (T15)

A

B

C

G

H

I

J



A 485



**A**

TORNEADO GENERAL Piezas de repuesto, mecanizado interior

**Diseño de sujeción por tornillo CoroTurn® 107**

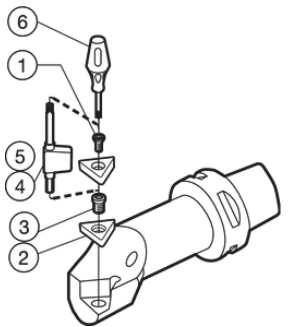
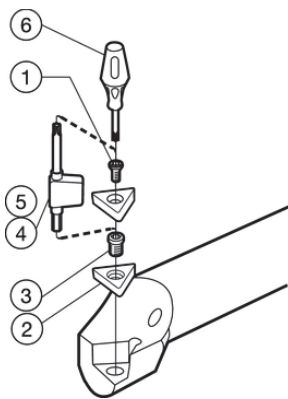

Portaplaquitas con mango			1
Pulgadas	Métrica	Coromant Capto®	Tornillo de plaquita (rosca)
 A04F-STFCR/L 1.2 A05H-STFCR/L 1.2	A06F-STFCR/L 06-R E06H-STFCR/L 06-R A06F-STFCR/L 06	-	5513 020-28 (M2)
E04H-STFCR/L-1.2R E05K-STFCR/L-1.2R A04F-STFCR/L-1.2R A05H-STFCR/L-1.2R	A08H-STFCR/L 06-R E08K-STFCR/L 06-R A08H-STFCR/L 06	-	5513 020-28 (M2)
E06M-STFCR/L-1.8 E08R-STFCR/L-1.8 A06M-STFCR/L-1.8R A08M-STFCR/L-1.8R A06M-STFCR/L 1.8 A08M-STFCR 1.8	A10K-STFCR/L 09-R A12M-STFCR/L 09-R E10M-STFCR/L 09-R E12Q-STFCR/L 09-R F10M-STFCR/L 09-R F12Q-STFCR/L 09-R A10K-STFCR/L 09 A12M-STFCR/L 09	-	5513 020-05 (M2.2)
A06M-STFCR/L-2-B1 <sup>2)</sup> A08M-STFCR/L-2-B1 <sup>2)</sup> A10R-STFCR/L-2-B1 <sup>2)</sup> A12S-STFCR/L-2-B1 <sup>2)</sup> A06M-STFCR/L 2-RB1 <sup>2)</sup> A08M-STFCR/L 2-RB1 <sup>2)</sup> A10R-STFCR/L 2-RB1 <sup>2)</sup> A12S-STFCR/L 2-RB1 <sup>2)</sup> E06M-STFCR/L-2-B1 <sup>2)</sup> E08R-STFCR/L-2-B1 <sup>2)</sup> E10R-STFCR/L-2-B1 <sup>2)</sup> E12S-STFCR/L-2-B1 <sup>2)</sup> E12R-STFCR/L-2-RB1 <sup>2)</sup> E16S-STFCR/L-2-RB <sup>2)</sup> E15S-STFCR/L 2-R A06M-STFCR/L 2 A08M-STFCR/L 2 A10R-STFCR/L 2 A12S-STFCR/L 2	A12M-STFCR/L 11-B1 <sup>2)</sup> A16R-STFCR/L 11-B1 <sup>2)</sup> A20S-STFCR/L 11-B1 <sup>2)</sup> E16R-STFCR/L 11-R E16R-STFCR/L 11-RB1 <sup>2)</sup> A16R-STFCR/L 11-RB1 <sup>2)</sup> A12M-STFCR/L 11-RB1 <sup>2)</sup> A20S-STFCR/L 11-RB1 <sup>2)</sup> A25T-STFCR/L 11 - RB1 <sup>2)</sup> A12M-STFCR/L 11 A16R-STFCR/L 11 A20S-STFCR/L 11  E20S-STFCR/L 11-RB1 E25T-STFCR/L 11-RB1	C3-STFCR/L-11065-11-B1 <sup>3)</sup> C3-STFCR/L-13075-11-B1 <sup>3)</sup> C4-STFCR/L-11070-11-B1 <sup>3)</sup> C4-STFCR/L-13080-11-B1 <sup>3)</sup> C5-STFCR/L-11070-11-B1 <sup>3)</sup> C5-STFCR/L-13080-11-B1 <sup>3)</sup>	5513 020-03 (M2.5)
E16T-STFCR/L-3 A16T-STFCR/L-3 E16S-STFCR/L 3-R A20T-STFCR/L-3 A24T-STFCR/L-3	A25T-STFCR/L 16-M E25T-STFCR/L 16-R  A32T-STFCR/L 16 A40T-STFCR/L 16	C3-STFCR/L-17090-16 C4-STFCR/L-17090-16 C5-STFCR/L-17090-16 C4-STFCR/L-22110-16 C5-STFCR/L-22110-16	5513 020-10 (M3.5) 5513 020-01 (M3.5)
A05F-STUCR/L 05-GR E05H-STUCR/L 05-GR A06F-STUCR/L 05-GR E06H-STUCR/L 05-GR A08H-STUCR/L 06-GR E08K-STUCR/L 06-GR A10K-STUCR/L 06-GR E10M-STUCR/L 06-GR			5513 020-53 5513 020-44 5513 020-28

Manguito magnético, véase la página A457

1) Las piezas opcionales deben pedirse por separado.

2) B1= para plaquitas con un espesor 2-1/8"

**I**

**J**





TURN - SPA

Piezas de repuesto, mecanizado interior TORNEADO GENERAL

**Diseño de sujeción por tornillo CoroTurn® 107**

2	3	4/5	6 <sup>1)</sup>		
Placa de apoyo	Para espesor de plaquita	Radio mm/pulgadas	Tornillo de placa de apoyo (rosca)	Llave (Torx Plus/mm)	Destornillador (Torx Plus)
-	-	-	-	5680 051-01 (6IP)	-
-	-	-	-	5680 051-01 (6IP)	-
-	-	-	-	5680 051-02 (7IP)	5680 046-03 (7IP)
-	-	-	-	5680 051-02 (7IP)	5680 046-03 (7IP)
-	-	-	-	5680 049-01 (15IP/3.5)	5680 046-02 (15IP)
5322 320-01	3.97/156	0.4-1.2/016-.047	5512 090-01 (M5x0.5)	5680 049-01 (15IP/3.5)	5680 046-02 (15IP)
-	-	-	-	5680 041-03 (6IP)	
-	-	-	-	5680 041-03 (6IP)	
-	-	-	-	5680 041-03 (6IP)	

A

B

C

G

H

I

J



A 487



**A**

TORNEADO GENERAL Piezas de repuesto, mecanizado interior

**Diseño de sujeción por tornillo CoroTurn® 107**

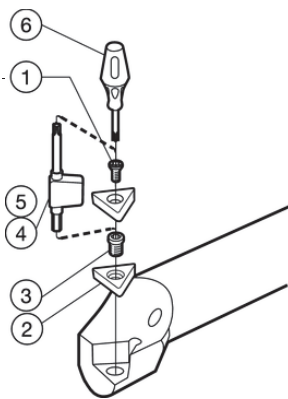

Portaplaquitas con mango			1
Pulgadas	Métrica	Coromant Capto®	Tornillo de plaquita (rosca)
 A10R-SVUBR/L 2-EB1 <sup>2)</sup> A12S-SVUBR/L 2-EB1 <sup>2)</sup> A16T-SVUBR/L 2-DB1 <sup>2)</sup> A10R-SVQBR/L 2E A10R-SVUBR/L 2-ERB1 <sup>2)</sup> A12S-SVUBR/L 2-ERB1 <sup>2)</sup> A10R-SVUBR/L 2-E A12S-SVUBR/L 2-D	A16R-SVUBR/L 11-EB1 <sup>2)</sup> A20S-SVUBR/L 11-EB1 <sup>2)</sup> A25T-SVUBR/L 11-DB1 <sup>2)</sup> A16R-SVUBR/L 11-ERB1 <sup>2)</sup> A20S-SVUBR/L 11-ERB1 <sup>2)</sup> A16R-SVQBR/L 11-ERB1 <sup>2)</sup> A20S-SVQBR/L 11-ERB1 <sup>2)</sup> A16R-SVUBR/L 11-E A20S-SVUBR/L 11-E A25T-SVUBR/L 11-E A25T-SVUBR/L 16-D	-	5513 020-20 (M2.5)
A20T-SVUBR/L 3 A24T-SVUBR/L 3 A32U-SVUBR/L 3	A32T-SVUBR/L 16 A40T-SVUBR/L 16	-	5513 020-10 (M3.5) 5513 020-01 (M3.5)
	A16R-SVQBR/L 11-EB1 <sup>2)</sup> A20S-SVQBR/L 11-EB1 <sup>2)</sup> A25T-SVQBR/L 11-DB1 <sup>2)</sup> A16R-SVQBR/L 11-E A20S-SVQBR/L 11-E A25T-SVQBR/L 11-D	C3-SVQBR/L-13070-11 C3-SVQBR/L-15080-11 C4-SVQBR/L-13070-11 C4-SVQBR/L-15080-11 C5-SVQBR/L-15080-11	5513 020-20 (M2.5)
A16T-SVQBR/L 3-D A20T-SVQBR/L 3 A16T-SVPBR/L 3 A24T-SVQBR 3 A20T-SVPBR/L 3 A24T-SVPBR/L 3	A25T-SVQBR/L 16-D A25T-SVPR/L 16 A32T-SVQBR/L 16 A40T-SVQBR/L 16 A32T-SVPR/L 16 A40T-SVPR/L 16	C3-SVQBR/L-18090-16 C4-SVQBR/L-18090-16 C5-SVQBR/L-18090-16 C3-SVQBR/L-22064-16 C3-SVQBR/L-22096-16 C4-SVQBR/L-22110-16 C4-SVQBR/L-27080-16 C4-SVQBR/L-27120-16 C5-SVQBR/L-22110-16 C5-SVQBR/L-27140-16 C5-SVQBR/L-35100-16 C5-SVQBR/L-35150-16 C6-SVQBR/L-22120-16 C6-SVQBR/L-27145-16 C6-SVQBR/L-35175-16	5513 020-10 (M3.5) 5513 020-01 (M3.5)

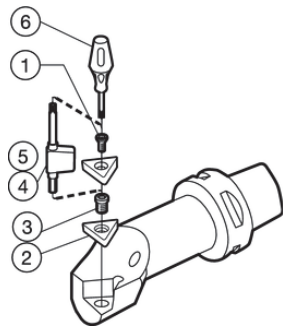

Manguito magnético, véase la página A457

**H**

Nota: barras de mandrinar CoroTurn® tipo SVQCR/L y SVUCR/L en la página A491.

- 1) Las piezas opcionales deben pedirse por separado.
- 2) B1= para plaquitas con un espesor 2-1/8"

**I**

**J**





TURN - SPA

Piezas de repuesto, mecanizado interior TORNEADO GENERAL

**Diseño de sujeción por tornillo CoroTurn® 107**

2			3	4/5	6 <sup>1)</sup>
Placa de apoyo	Para espesor de plaquita	Radio mm/pulgadas	Tornillo de placa de apoyo (rosca)	Llave (Torx Plus/mm)	Destornillador (Torx Plus)
-	-	-	-	5680 051-02 (7IP)	5680 046-03 (7IP)
-	-	-	-	5680 049-01 (15IP/3.5)	5680 046-02 (15IP)
5322 270-01	4.76/.187	0.4-0.8/.016-.031	5512 090-01 (M5x0.5)	5680 049-01 (15IP/3.5)	5680 046-02 (15IP)
5322 270-02 <sup>1)</sup>	4.76/.187	1.2/.047	-	-	-
-	-	-	-	5680 051-02 (7IP)	5680 046-03 (7IP)
-	-	-	-	5680 049-01 (15IP/3.5)	5680 046-02 (15IP)
5322 270-01	4.76/.187	0.4-0.8/.016-.031	5512 090-01 (M5x0.5)	5680 049-01 (15IP/3.5)	5680 046-02 (15IP)
5322 270-02 <sup>1)</sup>	4.76/.187	1.2/.047	-	-	-

A

B

C

G

H

I

J



A 489







A

TORNEADO GENERAL Piezas de repuesto, mecanizado interior

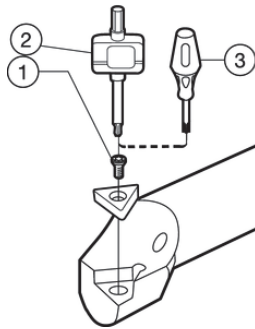
TURN - SPA

### Diseño de sujeción por tornillo CoroTurn® 111



Barras de mandrinar		1	2	3 <sup>1)</sup>																									
Pulgadas	Métrica	Tornillo de plaquita (rosca)	Llave (Torx Plus/mm)	Destornillador (Torx Plus)																									
 A05K-SCLPR/L 2 A06M-SCLPR/L 2 A05K-SCLPR/L 2-R A06M-SCLPR/L 2-R E05K-SCLPR/L 2 E06M-SCLPR/L 2 E06M-SCLPR/L 2-R A08M-SCLPR/L 2 A08M-SCLPR/L 2-R E08R-SCLPR/L 2 E08R-SCLPR/L 2-R	A08K-SCLPR/L 06 A10K-SCLPR/L 06 A08K-SCLPR/L 06-R A10K-SCLPR/L 06-R E08K-SCLPR/L 06-R E10M-SCLPR/L 06-R	5513 020-21 (M2.5)	5680 051-02 (7IP)	5680 046-03 (7IP)																									
					 A06M-SDUPR/L 2-E A08M-SDUPR/L 2-E A06M-SDUPR/L 2-ER A08M-SDUPR/L 2-ER E06M-SDUPR/L 2-E E08R-SDUPR/L 2-E E06M-SDUPR/L 2-ER E08R-SDUPR/L 2-ER F06M-SDUPR/L 2-ER F08Q-SDUPR/L 2-ER	A10K-SDUPR/L 07-E A10K-SDUPR/L 07-ER E10M-SDUPR/L 07-ER F10M-SDUPR/L 07-ER	5513 020-48 (M2.5)	5680 051-02 (7IP)	5680 046-03 (7IP)																				
										A10R-SDUPR/L 2 A10R-SDUPR/L 2-E A10R-SDUPR/L 2-ER A10R-SDUPR/L 2-ERX E10R-SDUPR/L 2 E10R-SDUPR/L 2-R E10R-SDUPR/L 2-ERX E10R-SDUPR/L 2-EX	A12M-SDUPR/L 07-E A12M-SDUPR/L 07-ER A16R-SDUPR/L 07 A16R-SDUPR/L 07-R A16R-SDUPR/L 07-ERX A16R-SDUPR/L 07-EX E12Q-SDUPR/L 07-ER E16R-SDUPR/L 07-R E16R-SDUPR/L 07-ERX F12Q-SDUPR/L 07-ER	5513 020-03 (M2.5)	5680 051-02 (7IP)	5680 046-03 (7IP)															
															A12S-SDUPR/L 3 A12S-SDUPR/L 3-R A16T-SDUPR/L 3-ER	A20S-SDUPR/L 11 A20S-SDUPR/L 11-R A25T-SDUPR/L 11	5513 020-09 (M3.5)	5680 049-01 (15IP)	5680 046-02 (15IP)										
																				A10R-SDXPR/L 2-E A10R-SDXPR/L 2-ER	A16R-SDXPR/L 07-E A16R-SDXPR/L 07-ER	5513 020-03 (M2.5)	5680 051-02 (7IP)	5680 046-03 (7IP)					
																									 A04F-STFPR/L 1.2-R A04F-STFPR/L 1.2 E04H-STFPR/L 1.2-R A05H-STFPR/L 1.2 A05H-STFPR/L 1.2-R E05K-STFPR/L 1.2-R A06M-STFPR/L 1.8 A06M-STFPR/L 1.8-R A08M-STFPR/L 1.8 A08M-STFPR/L 1.8-R E06M-STFPR/L 1.8 E06M-STFPR/L 1.8-R E08Q-STFPR/L 1.8-R E08Q-STFPR/L 1.8 F06M-STFPR/L 1.8-R F08Q-STFPR/L 1.8-R	A06H-STFPR/L 06 A06F-STFPR/L 06-R E06H-STFPR/L 06-R A08K-STFPR/L 06 A08H-STFPR/L 06-R E08K-STFPR/L 06-R A10K-STFPR/L 09 A10K-STFPR/L 09-R A12M-STFPR/L 09 A12M-STFPR/L 09-R E10M-STFPR/L 09-R E12Q-STFPR/L 09-R F10M-STFPR/L 09-R F12Q-STFPR/L 09-R	5513 020-47 (M2.5)	5680 051-02 (7IP)	5680 046-03 (7IP)
															A08M-STFPR/L 2 A08M-STFPR/L 2-R E08R-STFPR/L 2 E08R-STFPR/L 2-R	A12M-STFPR/L 11 A12M-STFPR/L 11-R E12Q-STFPR/L 11-R	5513 020-48 (M2.5)	5680 051-02 (7IP)	5680 046-03 (7IP)										
																				A10R-STFPR/L 2 A10R-STFPR/L 2-R E10R-STFPR/L 2 E10R-STFPR/L 2-R	A16R-STFPR/L 11 A16R-STFPR/L 11-R E16R-STFPR/L 11-R	5513 020-03 (M2.5)	5680 051-02 (7IP)	5680 046-03 (7IP)					
															A12S-STFPR/L 3 A12S-STFPR/L 3-R A16T-STFPR/L 3	A20S-STFPR/L 16 A20S-STFPR/L 16-R A25S-STFPR/L 16	5513 020-09 (M3.5)	5680 049-01 (15IP)	5680 046-02 (15IP)										

<sup>1)</sup> Piezas opcionales suministradas en pedido separado







TURN - SPA

Piezas de repuesto, mecanizado interior TORNEADO GENERAL

**CoroTurn® 111/107 sujeción por tornillo**

Barras de mandrinar		1	2	3 <sup>1)</sup>
Pulgadas	Métrica	Tornillo de plaquita (rosca)	Llave (Torx Plus/mm)	Destornillador (Torx Plus)
<b>CoroTurn® 107</b>				
				
A10R-SVUCR/L 2-E A10R-SVUCR/L 2-ER E10R-SVUCR/L 2-E E10R-SVUCR/L 2-ER	A16R-SVUCR/L 11-E A16R-SVUCR/L 11-ER E16R-SVUCR/L 11-E	5513 020-03 (M2.5)	5680 051-02 (7IP)	5680 046-03 (7IP)
A10R-SVQCR/L 2-E A10R-SVQCR/L 2-ER E10R-SVQCR/L 2-E	A16R-SVQCR/L 11-E A16R-SVQCR/L 11-ER E16R-SVQCR/L 11-E	5513 020-03 (M2.5)	5680 051-02 (7IP)	5680 046-03 (7IP)
<b>CoroTurn® 111</b>				
				
A03F-SWLPR/L 1.2-R A03H-SWLPR/L 1.2-R A04F-SWLPR/L 1.2 A04F-SWLPR/L 1.2-R E04H-SWLPR/L 1.2-R	A05F-SWLPR/L 02-R E05H-SWLPR/L 02-R	5513 020-53 (M2.0)	5680 051-01 (6IP)	-
A05H-SWLPR/L 1.2 A05H-SWLPR/L 1.2-R E05K-SWLPR/L 1.2-R	A06F-SWLPR/L 02 A06F-SWLPR/L 02-R A08H-SWLPR/L 02 A08H-SWLPR/L 02-R E06H-SWLPR/L 02-R E08K-SWLPR/L 02-R	5513 020-44 (M2.0)	5680 051-01 (6IP)	-
A06M-SWLPR/L 2 A06M-SWLPR/L 2-R E06M-SWLPR/L 2-R	A10K-SWLPR/L 04 A10K-SWLPR/L 04-R E10M-SWLPR/L 04-R	5513 020-21 (M2.5)	5680 051-02 (7IP)	5680 046-03 (7IP)
A08M-SWLPR/L 2 A08M-SWLPR/L 2-R E08R-SWLPR/L 2 E08R-SWLPR/L 2-R	A12M-SWLPR/L 04 A12M-SWLPR/L 04-R E12Q-SWLPR/L 04-R	5513 020-46 (M2.5)	5680 051-02 (7IP)	5680 046-03 (7IP)

1) Piezas opcionales suministradas en pedido separado

Manguito magnético, véase la página A457



A 491





**A**





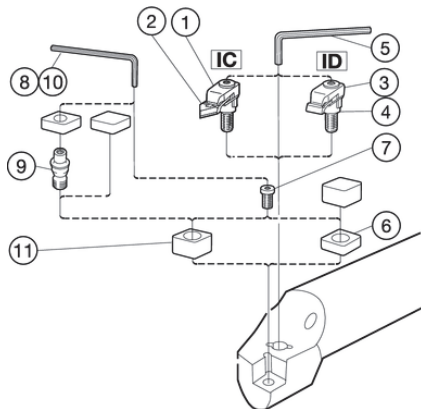

TORNEADO GENERAL Piezas de repuesto, mecanizado interior

**T-Max® sujeción por brida superior para plaquitas de cerámica**

**B**



**C**

	1	2	3		4	5
Herramienta con mango redondo	Brida (IC)	Rompevirutas (IC) A derecha	Neutro	A izquierda	Brida (ID)	Placa de presión (ID) Llave (mm)
 S40T-CCLNR/L 12-IC S50U-CCLNR/L 12-IC	5412 125-02	-	5192 022-04	-	5412 125-02 <sup>1)</sup>	5192 020-01 <sup>1)</sup> 3021 010-040 (4.0)
<b>G</b>  S25T-CRSPR/L 09-ID S40T-CRSNR/L 12-ID	-	-	-	-	5412 126-03 5412 125-01	- 5192 020-01 3021 010-040 (4.0)
 S40T-CSKNR/L 12-IC	5412 125-02	5192 022-05	-	5192 022-05	5412 125-02 <sup>1)</sup>	5192 020-01 <sup>1)</sup> 3021 010-040 (4.0)
	6	7	8	9 <sup>1)</sup>	11 <sup>1)</sup>	10 <sup>1)</sup>
Herramienta con mango redondo	Placa de apoyo (para espesor de plaquita)	Tornillo de la placa de apoyo	Llave (Torx Plus)	Pasador central (IP)	Placa de apoyo (para espesor de plaquita)	Llave (mm)
 S40T-CCLNR/L 12-IC S50U-CCLNR/L 12-IC	5322 233-01 (7.94/.312)	5513 013-02 (20IP)	5680 043-14 (20IP)	5313 032-02	5322 233-02 (4.76/.187)	174.1-863 (2.5)
 S25T-CRSPR/L 09-ID S40T-CRSNR/L 12-ID	-	-	-	-	-	-
 S40T-CSKNR/L 12-IC	5322 141-01 (7.94/.312)	5513 013-02 (20IP)	5680 043-14 (20IP)	5313 032-02	5322 141-02 (4.76/.187)	174.1-863 (2.5)
	5322 421-01 (7.94/.312)	5513 013-02 (20IP)	5680 043-14 (20IP)	5313 032-02	5322 421-02 (4.76/.187)	174.1-863 (2.5)

<sup>1)</sup> Piezas opcionales suministradas en pedido separado

**I**

**J**

