

NACHI

UVN SERIES
VARIABLE VOLUME VANE UNI-PUMP

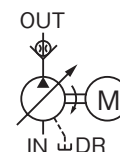

UVN Series Variable Volume Vane Uni-pump
(NSP Uni-pump)

3 to 26cm³/rev
8MPa{81.6kgf/cm²}

Features

1. Energy efficient high performance

All the performance of a vane pump, right from the low pressure range, is enhanced even further by eliminating the external drain and optimizing the pressure balance, creating a design that generates little heat.

The result is a pump that contributes to the energy efficiency of the mother machine, as well as to process precision.

2. Lightweight, compact design

The pump and motor are designed for exclusive uni-pump use, making them lightweight, compact, easy to handle, and suitable for a wide range of applications.

3. Low noise, long life

The pump and motor shaft are linked by a joint, which minimizes noise by eliminating the effects of shaft vibration and an off-center shaft.

The coupling is constructed to allow constant lubrication, for friction-free long life.

Specifications

Model No.	Pump Capacity cm ³ /rev	Pressure Adjustment Range MPa{kgf/cm ² }	No-load Discharge Rate ℓ/min	
			50Hz	60Hz
UVN-1A-0A2- ^{0.7} / _{1.5} -4-12	8.1	1.5 to 4.0 {15.3 to 40.8}	12	14.5
UVN-1A-0A3- ^{0.7} / _{1.5} -4-12		3.5 to 6.0 {35.7 to 61.2}		
UVN-1A-0A4- ^{0.7} / _{1.5} -4-12		5.5 to 8.0 {56.1 to 81.6}		
UVN-1A-1A2- ^{1.5} / _{2.2} -4-12	16.1	1.5 to 4.0 {15.3 to 40.8}	24	29
UVN-1A-1A3- ^{1.5} / _{2.2} -4-12		3.5 to 6.0 {35.7 to 61.2}		
UVN-1A-1A4- ^{1.5} / _{2.2} -4-12		5.5 to 8.0 {56.1 to 81.6}		
UVN-1A-2A2- ^{2.2} / _{3.7} -4-30	26.0	2.0 to 4.0 {20.4 to 40.7}	39	46
UVN-1A-2A3- ^{2.2} / _{3.7} -4-30		3.5 to 6.0 {35.7 to 61.2}		
UVN-1A-2A4-3.7-4-30		5.5 to 7.0 {56.1 to 71.4}		

Note1) Contact your agent for combinations other than those noted above.

Note2) Due to the change of designs from 11 to 12, 20 to 30, the color of paint is changed to black.

Explanation of model No.

UVN - 1 A - 1 A 4 - 1.5 - 4 - 12

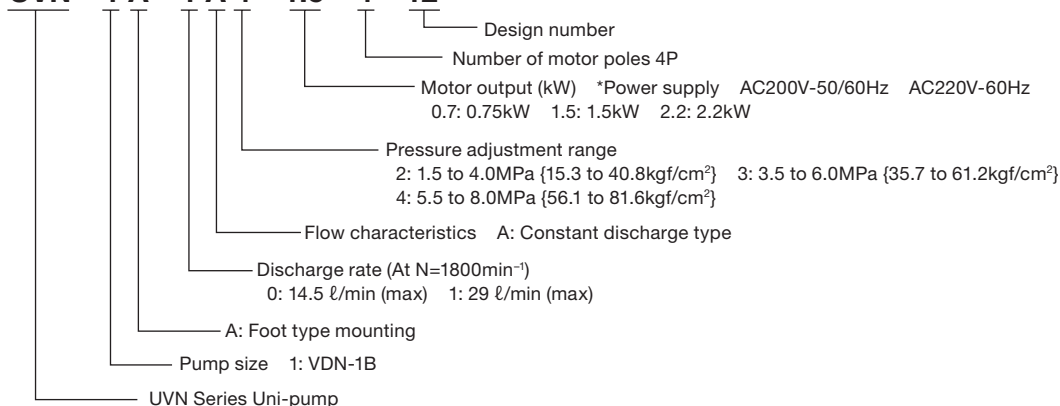

UVN -1 A - 2 A 3 - 3.7 A E - 4 * - 30

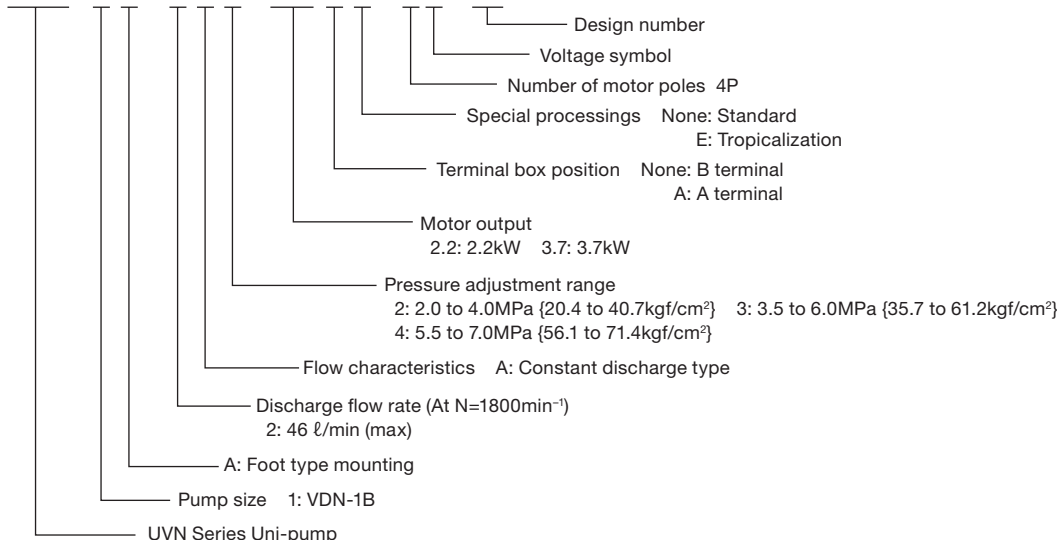

● Handling

1. Installation and Piping Precautions

- 1 Provide a mounting base of sufficient rigidity, and install so that the pump shaft is oriented horizontally.
- 2 Make sure the flow rate of the suction piping is no more than 2m/s, and that the suction pressure at the pump suction port is in the range of -0.03 to +0.03MPa.
- 3 Drain piping must be direct piping up to a point that is below the tank fluid level, and back pressure due to pipe resistance should not exceed 0.01MPa.
Provide a suction strainer with a filtering grade of about 100 μm (150 mesh).

2. Running Precautions

- 1 The direction of rotation is clockwise (rightward) when viewed from the motor fan side.
- 2 At startup, repeat the inching operation with the pump discharge side at no-load to prime the pump and bleed air from the pump and suction piping. (This pump has no fluid supply port.)
- 3 Equip an air bleed valve in circuits where it is difficult to bleed air before startup.
- 4 Make sure the maximum peak pressure (setting pressure + surge pressure) during operation does not exceed 14MPa.
Refer to the following piping conditions as a guideline to keep the maximum peak pressure below 14 MPa.
1/2" x 2 m rubber hose (Discharge rate 0; Type 1 14MPa, Type 2 13MPa) (pipe volume: approximately 250 cm³)
- 5 Install a relief valve to cut surges in the circuit if pressure exceeds 14 MPa.

Note) The maximum peak pressure of the discharge rate Type 2 is 13MPa.

3. Management of Hydraulic Operating Fluid

- 1 Use only good-quality hydraulic operating fluid with a kinematic viscosity at a oil temperature of 40°C within the range of 30 to 50mm²/sec (30 to 50cSt). Normally, you should use an R&O type and wear-resistant type of ISO VG32 or 46, or equivalent.
- 2 The operating temperature range is 15 to 60°C. When the oil temperature at startup is 15°C or less, perform a warm-up operation at low pressure until the oil temperature reaches 15°C. Use the pump in an area where the temperature is within the range of 10 to 40°C.
- 3 For the return line to the tank, use a 25μm line filter.
- 4 Manage hydraulic operating fluid so contamination is maintained at class NAS10 or lower. Take care to avoid contamination with water, foreign matter, and other oil, and watch out for discoloration.

4. Setting the Pressure and Discharge Rate

- 1 When adjusting pressure, pressure is increased by clockwise (rightward) rotation of the adjusting screw and decreased by counterclockwise (leftward) rotation. After adjustment is complete, securely tighten the lock nut.
- 2 Turn adjustment screw right to decrease or left to increase volume of discharge. Refer to guidelines in the following diagram for the relationship of the non-load volume of discharge and the position of the flow adjustment screw.

Flow Adjustment Rotation Angle (θ) and Pump Capacity (q)

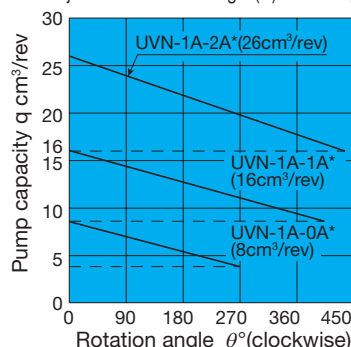

Note) The values indicated above are at maximum pump discharge volume with the flow volume adjusting screw at the 0° position. The broken line shows the flow volume adjustment range lower limit value.

After adjustment is complete, securely tighten the lock nut.

- 3 Factory Default P-Q Settings (Standard Model)
 - Flow Rate Setting = Maximum flow rate for model as indicated in the catalog
 - Pressure Setting = Pressure shown in table below

Factory Default Pressure Settings MPa(kgf/cm²)
2 : 3.5 {35.7}
3 : 5.0 {51.0}
4 : 7.0 {71.4}

- 4 All adjustments, except the flow volume adjusting screw, are precision adjusted at the factory during assembly, do not adjust them.

(Do not make any adjustments other than the pressure adjustment screw and the flow rate adjusting screw.)

Note) The values indicated above are at maximum pump discharge volume with the flow volume adjusting screw at the 0° position. The broken lines show the flow volume adjustment range lower limit value.

● Inverter Drive Precautions

- 1 Set the revolution speed within the range of the pump specification revolution speed.
- 2 Changing the revolution speed may also affect the pump performance curves. Before using the inverter, check if the pressure and motor load factor are within the range of use.

Installation Dimension Drawings

Installation method is the same as design number 10D (old design).

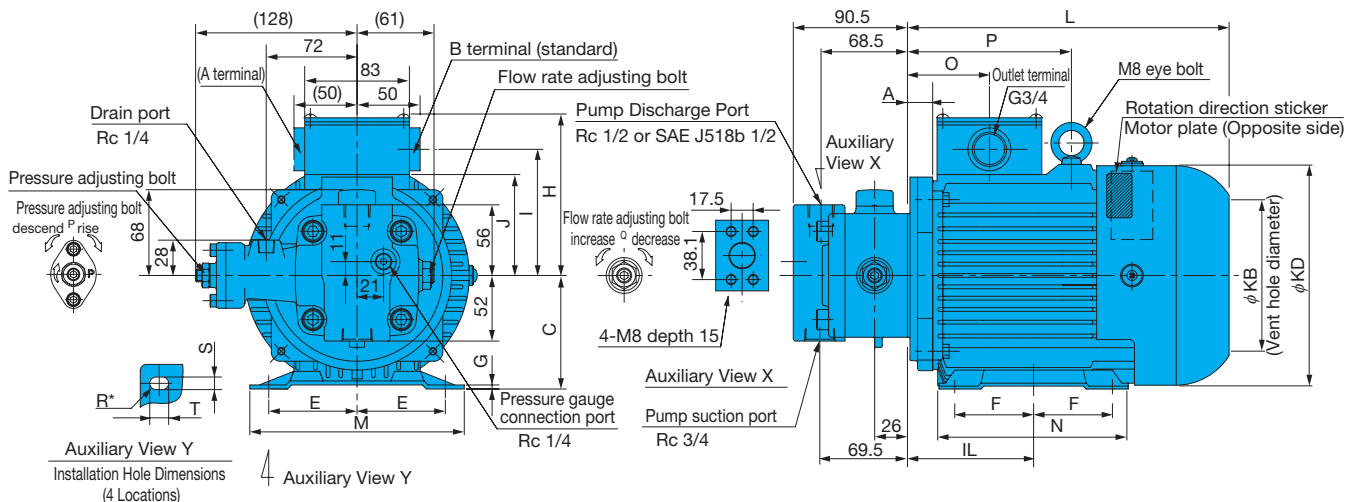

Model No.	Output - Poles (kW-4P)	Motor Dimensions (mm)																	Weight kg	
		A	IL	C	φKD	E	F	G	H	J	L	M	N	TxS	R*	φKB	O	P		I
UVN-1A-0 ₁ A*-0.7*-4-12	0.75-4	20	90	80	157	62.5	50	2.3	120	72	230	155	120	15x10	R5	110	65	130	92	19
UVN-1A-0 ₁ A*-1.5*-4-12	1.5-4	20	100	90	175	70	62.5	3.2	128	80	255	170	150	15x10	R5	120	65	130	100	23
UVN-1A-0 ₁ A*-2.2*-4-12	2.2-4	20	110	100	195	80	70	3.2	138	90	285	200	165	17x12	R6	134	65	135	110	30

- Pump Capacity and Motor Output Category Combinations -

	0.75kW	1.5kW	2.2kW
0A*	○	○	○
1A*	○	○	○

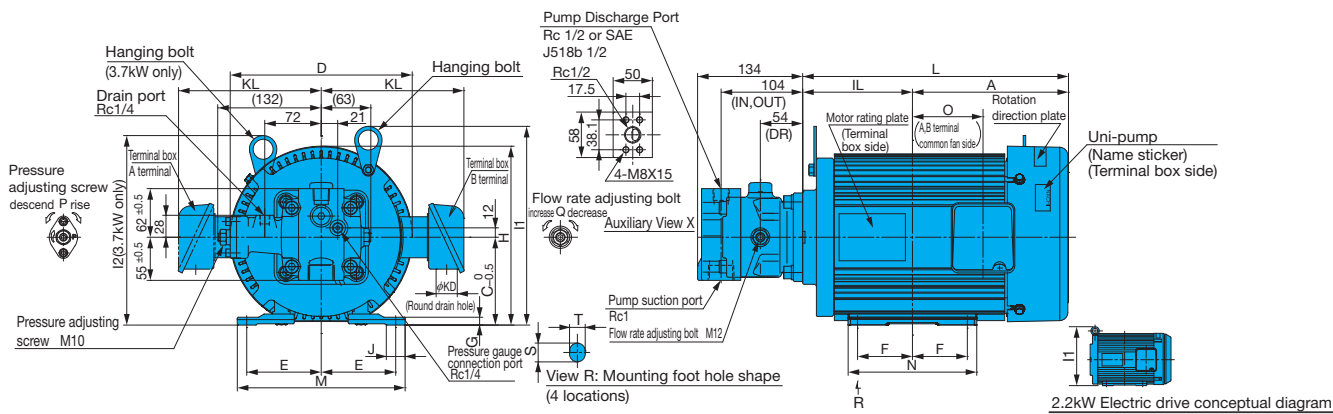

Model No.	Motor Dimensions [mm]																	Frame No.	Output [kW] (4 poles)	Weight [kg]	
	A	IL	C	D	E	F	G	H	I1	I2	J	L	M	N	SxT	φKD	KL				O
UVN-1A-2A*-2.2*-4*-30	179	133	100	206	80	70	7	203	226	-	39	312	206	170	14x12	27	153	83	100L	2.2	46
UVN-1A-2A*-3.7*-4*-30	199	140	112	233	95	70	10	228	253	242	24	339	214	164	14x12	27	182	90	112M	3.7	50

- Standard drive motor is the fully enclosed fan-cooled E type.
- Standard voltage for drive motor is 200 VAC, 50/60 Hz or 220 VAC, 60 Hz.
- Standard terminal box is B terminal (right side viewed from pump).

-Pump Pressure Classification and Motor Output Combinations-

	2.2kW	3.7kW
2A2	○	○
2A3	○	○
2A4	○	○

Characteristics of drive motor for unipump (domestic standard 3 rating)

UVN-1A-0₁A*

Output kW	Poles	Model Number	Voltage [V]	Frequency [Hz]	Current rating [A]	RPM rating [min ⁻¹]	Heat resistance
0.75	4	The drive motor is specialized for the unipump and is not a specific model.	200	50	4.3	1440	E
			200	60	3.6	1730	
			220	60	3.6	1745	
1.5	4		200	50	7.3	1440	E
			200	60	6.4	1730	
			220	60	6.2	1740	
2.2	4		200	50	10.3	1450	E
			200	60	9.2	1745	
			220	60	8.9	1755	

UVN-1A-2A*

Output kW	Poles	Model Number	Voltage [V]	Frequency [Hz]	Current rating [A]	RPM rating [min ⁻¹]	Heat resistance
2.2	4	VAEA-1A4*22-B	200	50	9.5	1460	F
			200	60	8.8	1750	
			220	60	8.5	1760	
3.7	4	VAEA-1A4*37-B	200	50	15.4	1460	F
			200	60	14.3	1760	
			220	60	13.5	1760	

Performance Curves

UVN-1A-*A*-*4-12

Operating Fluid: ISO VG 32

Oil temperature: 40°C

Motor selection curves

The area under a motor output curve in the graph below is the operating range for that motor under the rated output for that motor.

Example:

To find the motor that can produce pressure of 3.5MPa and a discharge rate of 12ℓ/min.

Selection Process

Since the intersection of the two broken lines from a pressure of 3.5MPa and discharge rate of 12ℓ/min intersect in the area under the 1.5kW curve, it means that a 1.5kW motor should be used.

* Select a uni-pump that has a pressure and flow rate that is within the range of the drive so that the drive will not overload.

* When the startup current of the uni-pump becomes higher for the IE1 motor, breakers may need to be changed.

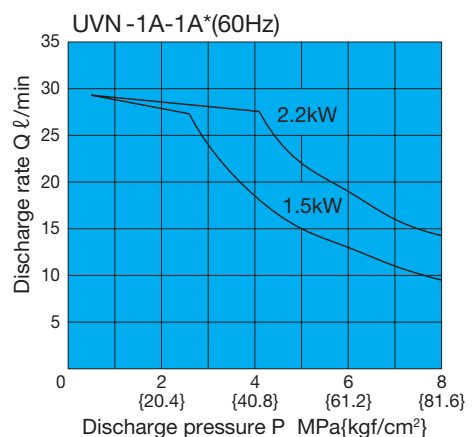
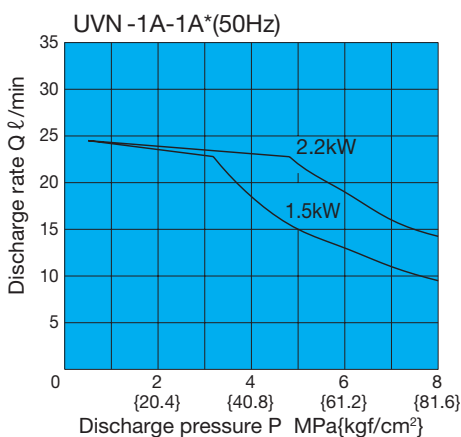
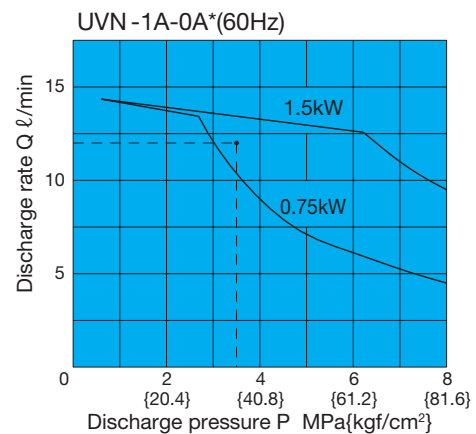
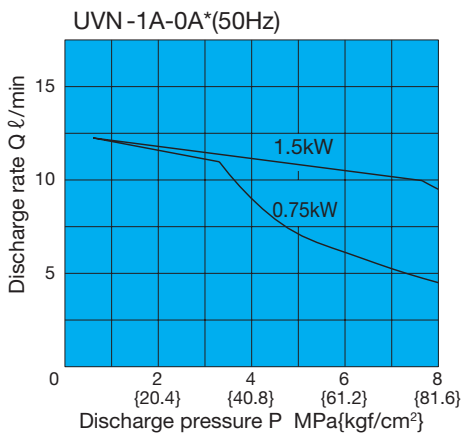

Motor selection curves (26cm³/rev)

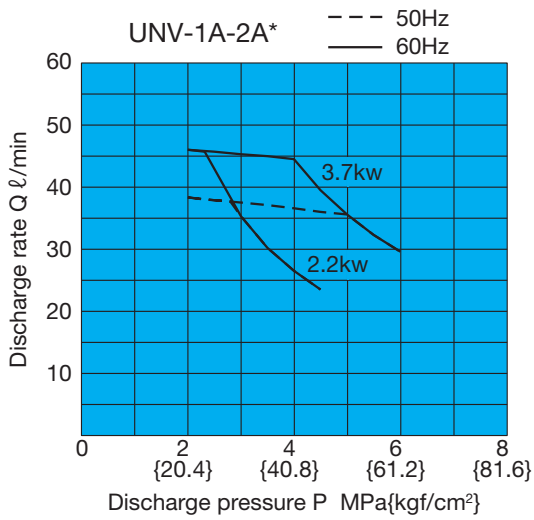

Motor Power Loss at Full Cutoff

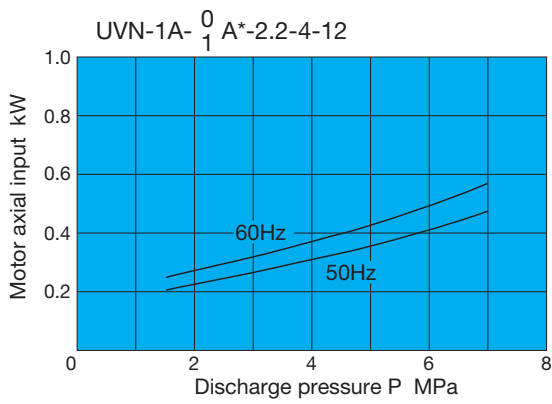

DR Volume a Full Cutoff

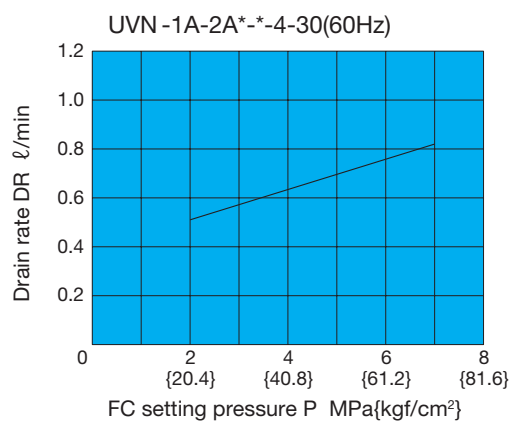
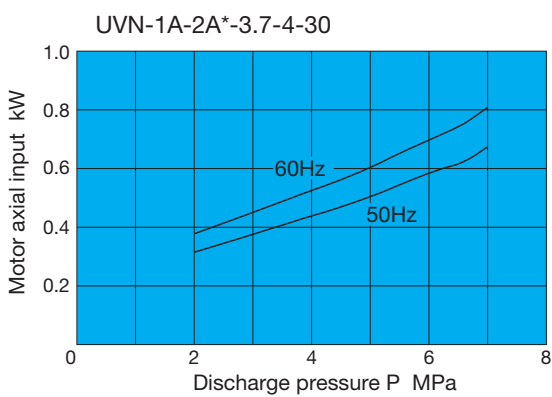
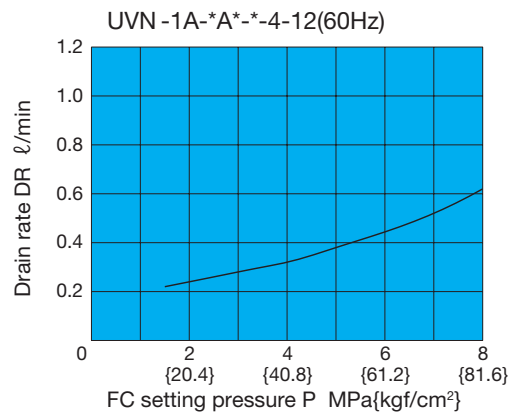

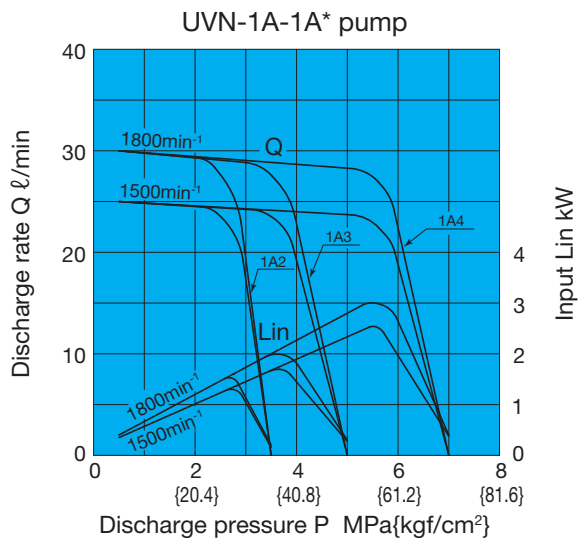
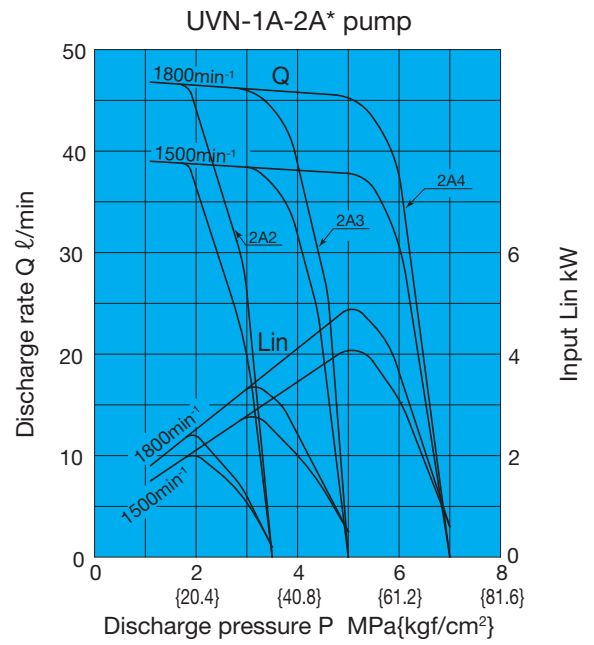
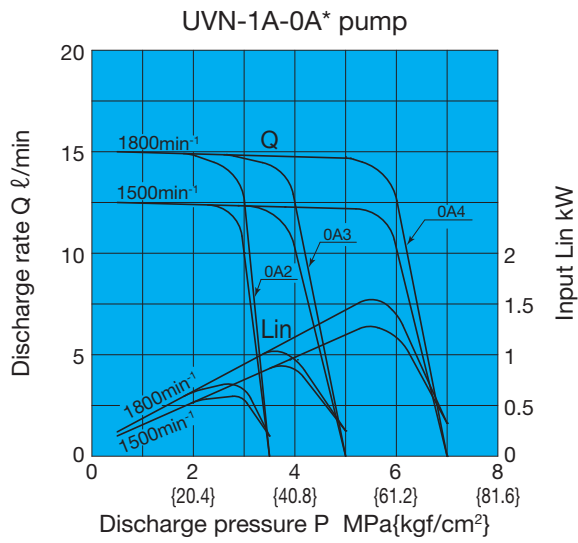

*The pressure - flow rate characteristics are the characteristics for individual UVN pumps.
The pressure and flow rate must be within the output range of the motor.
See page B-43 for the output ranges of drive motors.